

iBoard®



Scan for
Installation Video

iBoard® by APS

PART#: IB-058S C&H

READ INSTRUCTIONS CAREFULLY BEFORE STARTING INSTALLATION. REMOVE CONTENTS FROM BOX AND VERIFY ALL PARTS ARE PRESENT. ASSISTANCE IS RECOMMENDED.

*ROCKER PANEL MOUNT
*NO DRILLING REQUIRED

Fastener Size	Tightening Torque (ft-lbs)	Required
6mm	6-7	X
8mm	16-18	√
10mm	31-32	X
12mm	56-58	X
14mm	92-94	X

PART LIST

Driver Side Step Bar

Front

Passenger Side Step Bar

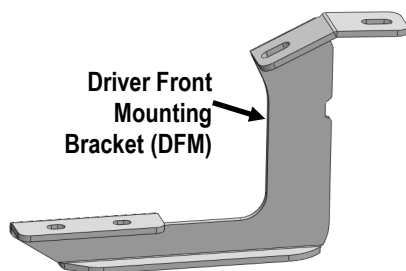
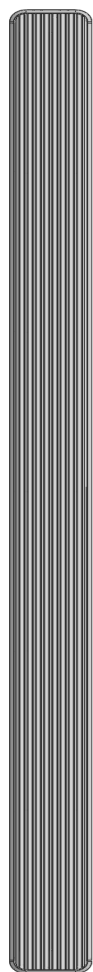

Driver Front Mounting Bracket (DFM)

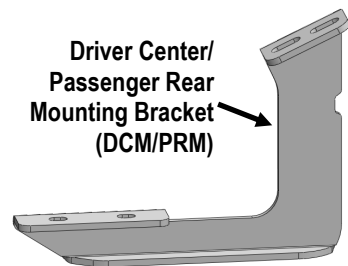

Driver Center/ Passenger Rear Mounting Bracket (DCM/PRM)

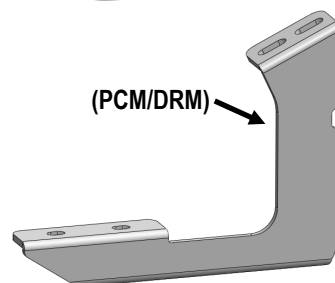

(PCM/DRM)

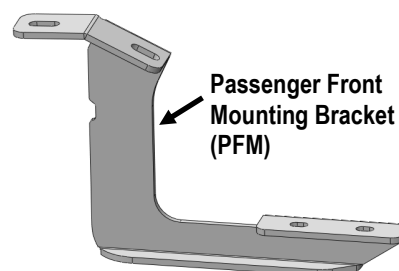

Passenger Front Mounting Bracket (PFM)

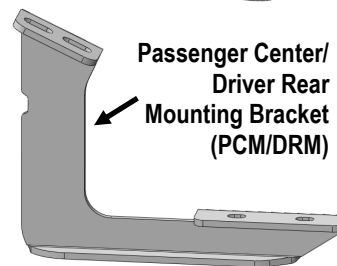

Passenger Center/ Driver Rear Mounting Bracket (PCM/DRM)

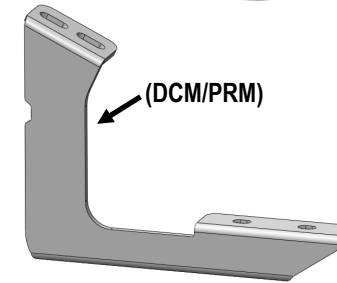

(DCM/PRM)

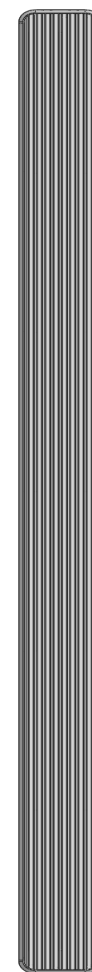

Customer Support: info@iboardauto.com



Scan for
Installation Video

Hardware Package A (For Bracket Installation)

Item	QTY	Description	Item	QTY	Description
1#	12	M8X1.25-30mm Hex Bolts	3#	12	M8 Lock Washers
2#	12	M8 Large Flat Washers			

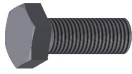

1 #



2 #



3 #

Hardware Package B (For Stainless Steel Step Bar Installation)

Item	QTY	Description	Item	QTY	Description
1#	12	M8X1.25-35mm Carriage Bolts	3#	12	M8 Nylon Lock Nuts
2#	12	M8 Large Flat Washers	4#	6	Sliders (Packed with Step Bars)

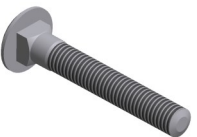

1 #



2 #



3 #



4 #



STEP 1

Start installation from the driver side front of the vehicle, remove the existing (2) factory bolts, (or plastic plugs) (**Fig 1**). This will be the mounting location for the Driver Front Mounting Bracket.



(Fig 1) Driver Side Front Mounting Location

STEP 2

Select the Driver Front Mounting Bracket, attach the Bracket to the vehicle using the included (2) M8x1.25-30mm Hex Bolts, (2) M8 Lock Washers and (2) M8 Large Flat Washers, (**Fig 2**). Do not fully tighten hardware at this time.

(2) M8x1.25-30mm Hex Bolts
(2) M8 Lock Washers
(2) M8 Large Flat Washers

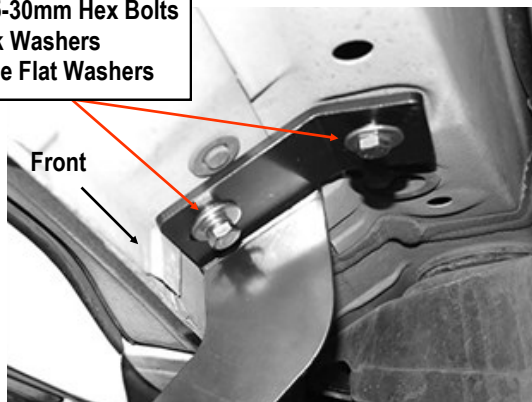

(Fig 2) Driver Front Mounting Bracket Installed

STEP 3

Move along the side panel to the Driver Side Center & Rear Mounting Locations, (**Fig 3**). Repeat **Steps 1 & 2** to install the Driver Center Mounting Bracket and Driver Rear Mounting Bracket, (**Fig 4**). Do not fully tighten hardware at this time.

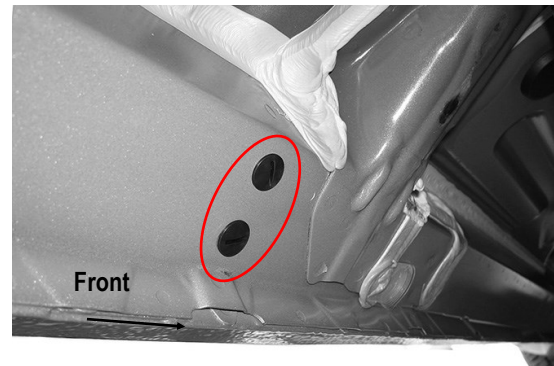

(Fig 3) Example of Driver Side Center & Rear Mounting Location



(Fig 4) Driver Center Mounting Bracket Installed

STEP 4

Once all (3) Driver side mounting brackets are installed, then proceed to the Step Bar installation. (**Figs 5 & 6**)

- (1) Select (1) Slider and (2) M8X1.25-35mm Carriage Bolts;
- (2) Install (2) M8X1.25-35mm Carriage Bolts in (1) Slider.
- (3) Slide the Slider (with carriage bolts) to the **Step Bar**.



- (4) Repeat to install the other (2) sliders to the step bar.
- (5) Attach the Step Bar (with the Sliders) onto the installed mounting brackets. Position the Sliders to the installed brackets. Secure the Step Bar to the installed Brackets by using (6) M8 Large Flat Washers and (6) M8 Nylon Lock Nuts and (3) Sliders, (Fig 6). Do not fully tighten hardware at this time.

Note: The Sliders are packed with the Step Bars.

Level and adjust the Step Bar and fully tighten all hardware.

Repeat **Steps 1-4** for the other side Step Bar installation.
The installation is completed!!!

Attention

Do periodic inspections to the installation to make sure that all hardware is secure and tight.

In order to protect your bars/boards, please use mild soap/non-abrasive products for cleaning only.

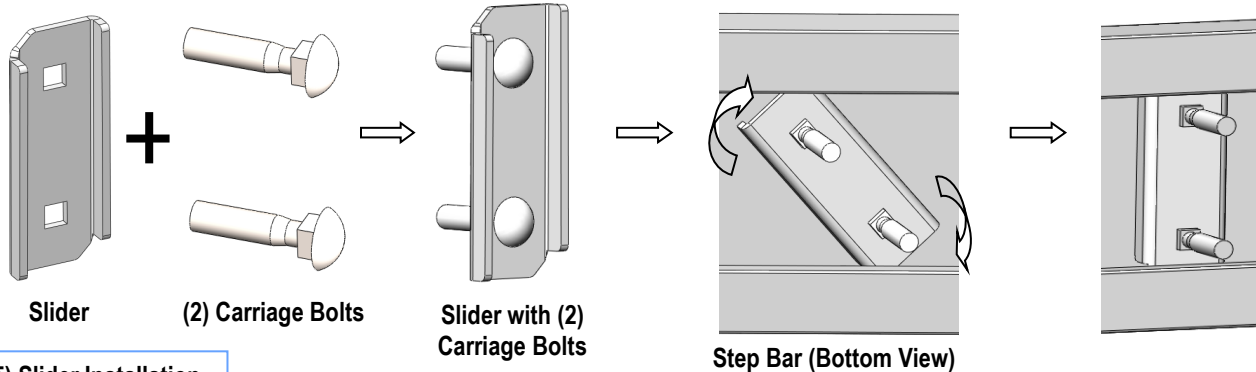

(Fig 5) Slider Installation

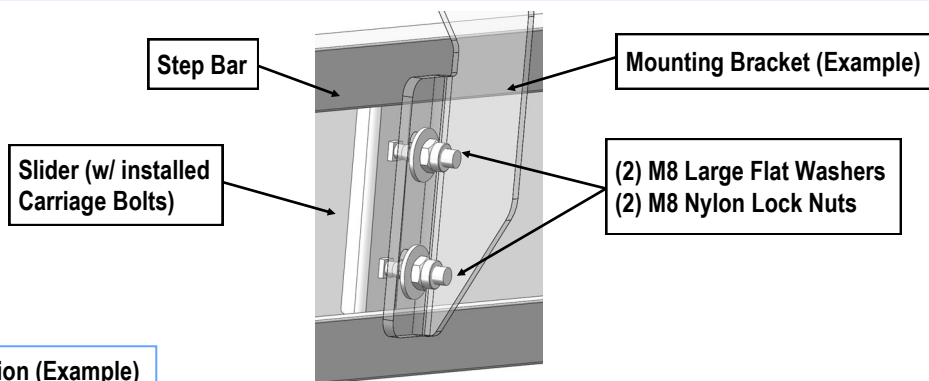

(Fig 6) Step Bar Installation (Example)