

# iBoard®

## iBoard® by APS

PART#: IB-082A-B

READ INSTRUCTIONS CAREFULLY BEFORE STARTING INSTALLATION. REMOVE CONTENTS FROM BOX AND VERIFY ALL PARTS ARE PRESENT. ASSISTANCE IS RECOMMENDED.

\*BODY FRAME MOUNT  
\*NO DRILLING REQUIRED

Fastener Size	Tightening Torque (ft-lbs)
6mm	6-7
8mm	16-18
10mm	31-32
12mm	56-58
14mm	92-94

### PART LIST

Front  
↑



Driver Front Mounting Bracket (DFM)

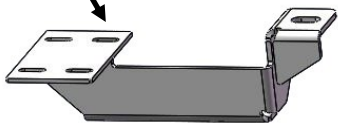

Passenger Front Mounting Bracket (PFM)



Driver Rear Support Bracket (DRS)

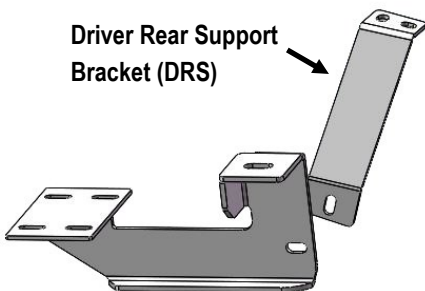

Passenger Rear Support Bracket (PRS)

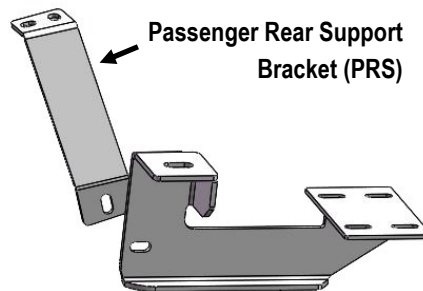

Driver Rear Mounting Bracket (DRM)



Passenger Rear Mounting Bracket (PRM)



Customer Support: [info@iboardauto.com](mailto:info@iboardauto.com)

# iBoard®

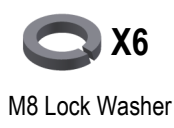

## STEP 1

Start installation from the driver side front of the vehicle. Remove front body mount nut and washer located underside of vehicle. **NOTE:** Use a pair of pliers or a crescent wrench to hold the bolt as you loosen the nut (**Fig 1**).

## STEP 2

Loosely attach Driver Front Mounting Bracket (**DFM**) using the factory nut and washer. **NOTE:** Keep factory rubber bushing and other factory body mount components in place (**Fig 1**).

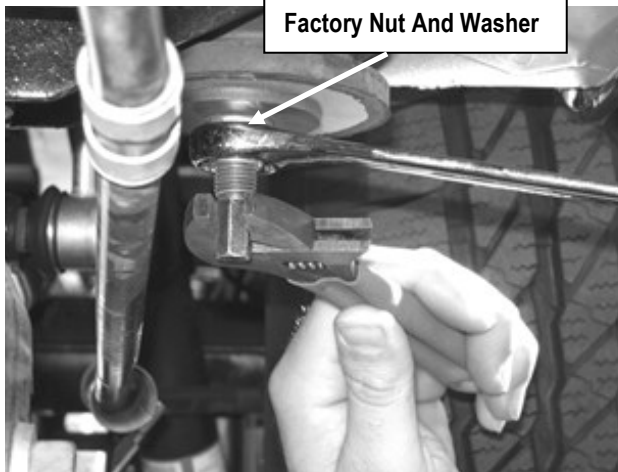

(Fig 1) Driver Front Mounting Bracket Installation

## STEP 3

Move toward the rear of the vehicle. Repeat **Steps 1-2** to install the Driver Rear Mounting Bracket (**DRM**), (**Fig 2**).

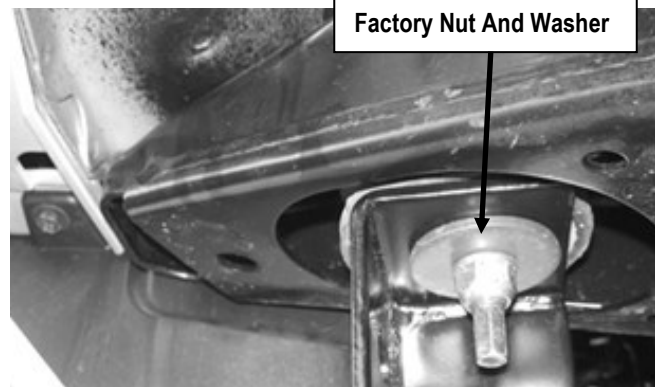

(Fig 2) Driver Rear Mounting Bracket Installation

## STEP 4

Locate the (2) factory threaded holes in the side panel by the rear body mounting location and attach the Driver Rear Support Bracket (**DRS**) to these factory holes using the included (2) M8X1.25-30mm Hex Bolts, (2) M8 Lock Washers, and (2) M8 Large Flat Washers, (**Fig 3**).

Attach opposite side of Driver Rear Support Bracket (**DRS**) to Driver Rear Mounting Bracket (**DFM**) using the included (1) M8X1.25-30mm Hex Bolt, (1) M8 Lock Washer, (1) M8X1.25 Hex Nut, and (2) M8 Large Flat Washers (**Fig 3 & 4**). Do not fully tighten at this time.

# iBoard®

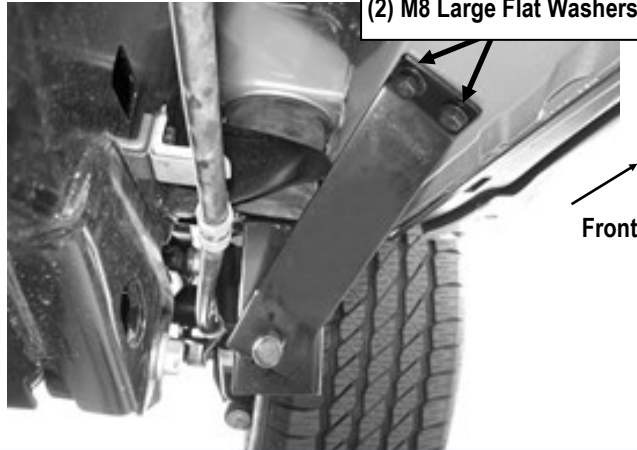

- (2) M8X1.25-30mm Hex Bolts
- (2) M8 Lock Washers
- (2) M8 Large Flat Washers

(Fig 3) Driver Rear Support Bracket Installation

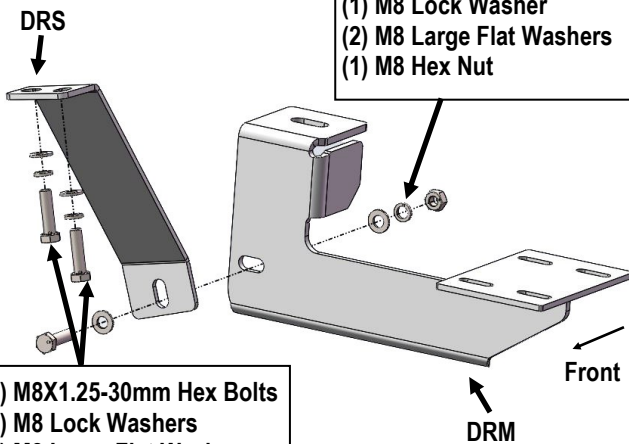

- (1) M8X1.25-30mm Hex Bolt
- (1) M8 Lock Washer
- (2) M8 Large Flat Washers
- (1) M8 Hex Nut

- (2) M8X1.25-30mm Hex Bolts
- (2) M8 Lock Washers
- (2) M8 Large Flat Washers

(Fig 4) Driver Rear Mounting Bracket Assembly

## STEP 5

Select a Running Board. Slip (4) M6X1-20mm Square Head Bolts into each bottom channel (Fig 5). Carefully position the Running Board onto the (2) Mounting Brackets.

**IMPORTANT:** Do not slide the Running Board on the Brackets or the bottom surface of the board will be damaged. Attach the Running Board to each Mounting Bracket with (4) M6x1-20mm Square Head Bolts, (4) M6 Large Flat Washers and (4) M6 X1 Nylon Lock Nuts (Fig 6). Do not fully tighten at this time.



(Fig 5) Slip M6X1-20mm Square Head Bolts Into The Bottom Channels

- (4) M6X1-20mm Square Head Bolts
- (4) M6 Large Flat Washers
- (4) M6X1 Nylon Lock Nuts

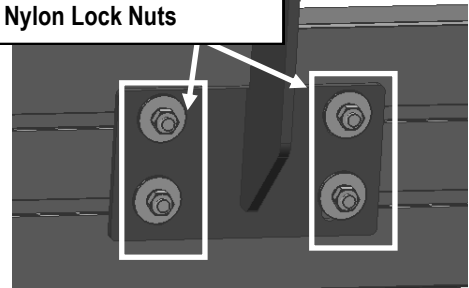

(Fig 6) Running Board Installed Onto the Mounting Bracket

## STEP 6

Level and adjust the Running Board and fully tighten all hardware.

## STEP 7

Repeat **Steps 1-6** for other side Running Board installation. The installation is completed (Fig 7).

# iBoard®



**(Fig 7) Installation Completed**

### **Attention**

**Do periodic inspections to the installation to make sure that all hardware is secure and tight.**

**In order to protect your bars/boards, please use only mild soap/non-abrasive products for cleaning.**