



## iBoard® by APS

PART#: IB-358C&H

READ INSTRUCTIONS CAREFULLY BEFORE STARTING INSTALLATION. REMOVE CONTENTS FROM BOX AND VERIFY ALL PARTS ARE PRESENT. ASSISTANCE IS RECOMMENDED.

\*ROCKER PANEL MOUNT  
\*NO DRILLING REQUIRED

Fastener Size	Tightening Torque (ft-lbs)	Required
6mm	6-7	X
8mm	16-18	√
10mm	31-32	X
12mm	56-58	X
14mm	92-94	X

### PART LIST

#### Driver Side Step Bar

Front

#### Passenger Side Step Bar

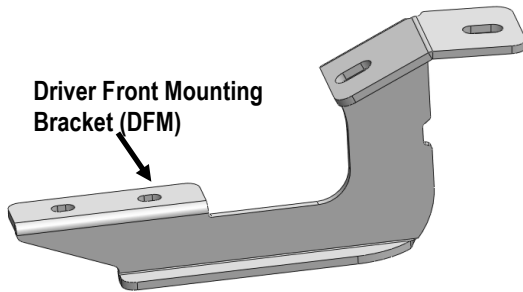
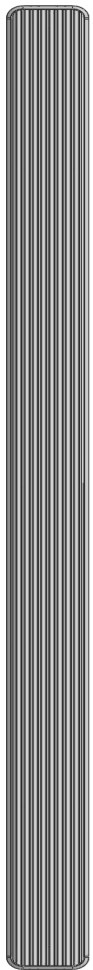

Driver Front Mounting Bracket (DFM)

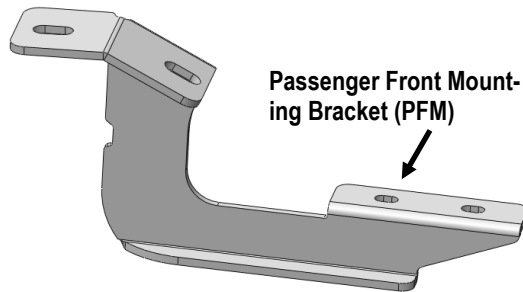

Passenger Front Mounting Bracket (PFM)

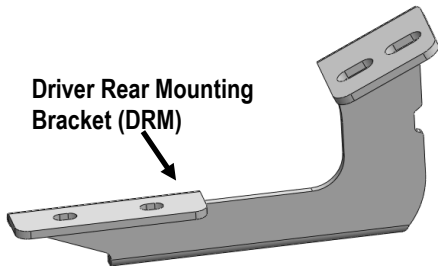

Driver Rear Mounting Bracket (DRM)

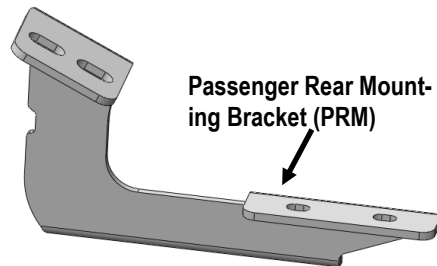

Passenger Rear Mounting Bracket (PRM)

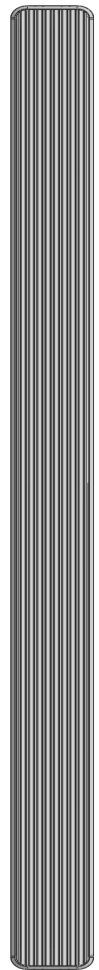



Scan for  
Installation Video

Hardware Package A (For Bracket Installation)					
Item	QTY	Description	Item	QTY	Description
1#	8	M8X1.25-30mm Hex Bolts	3#	8	M8 Lock Washers
2#	8	M8 Large Flat Washers			



1 #



2 #



3 #

Hardware Package B (For Stainless Steel Step Bar Installation)					
Item	QTY	Description	Item	QTY	Description
1#	8	M8X1.25-35mm Carriage Bolts	3#	8	M8 Nylon Lock Nuts
2#	8	M8 Large Flat Washers	4#	4	Sliders (Packed with Step Bars)

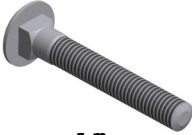

1 #



2 #



3 #

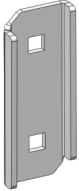

4 #



## STEP 1

Start installation from the driver side front of the vehicle. Remove the existing (2) factory bolts, (or plastic plugs) (Fig 1).

## STEP 2

Select and attach the Driver Front Mounting Bracket (DFM) to the vehicle with (2) M8x1.25-30mm Hex Bolts, (2) M8 Lock Washers and (2) M8 Large Flat Washers, (Fig 2). Do not fully tighten hardware at this time.

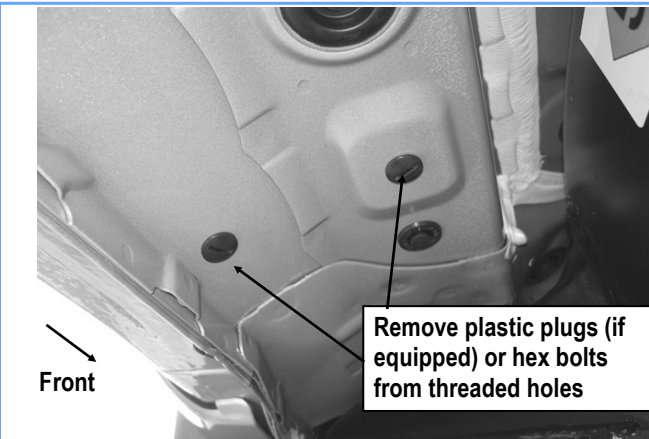

(Fig 1) Driver Side Front Mounting Location

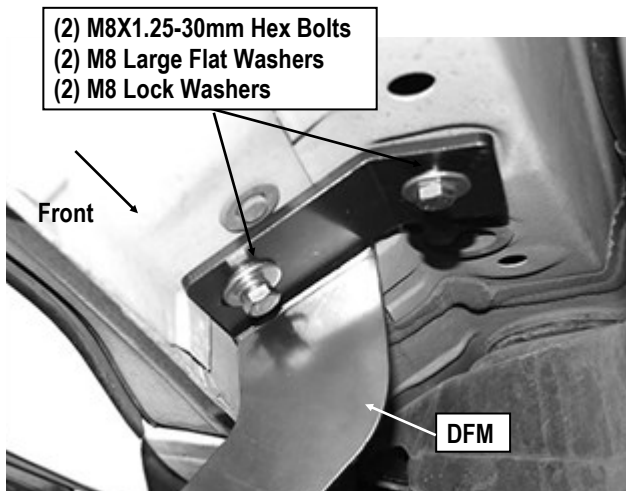

(Fig 2) Driver Front Mounting Bracket Installation

## STEP 3

Move to the driver side rear mounting location, (Fig 3). Repeat Steps 1 – 2 for Driver Rear Mounting Bracket (DRM) installation, (Fig 4). Do not fully tighten hardware at this time.

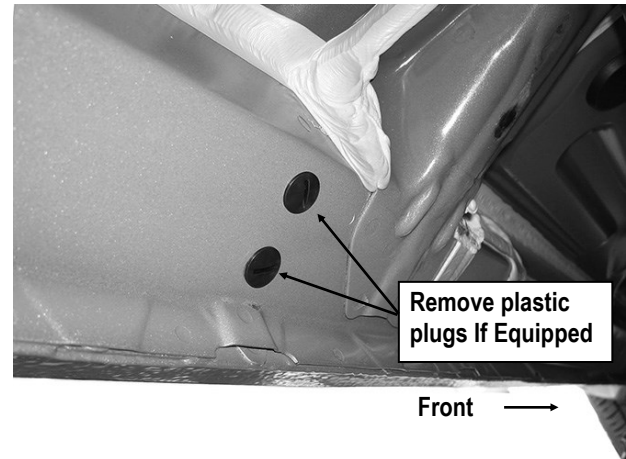

(Fig 3) Driver Side Rear Mounting Location

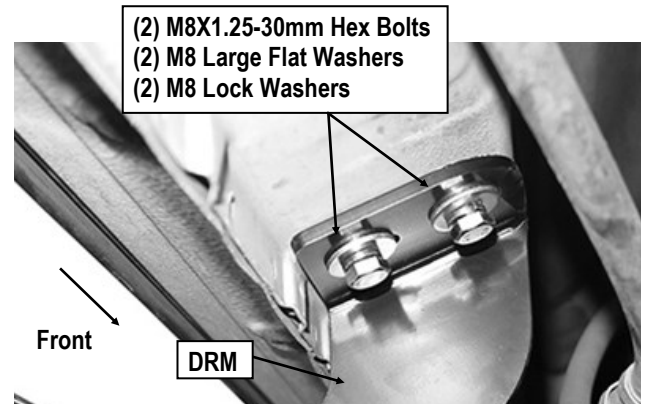

(Fig 4) Driver Rear Mounting Bracket Installation



## STEP 4

Once all (2) Driver side mounting brackets are installed, then proceed to the Step Bar installation. (Figs 5&6)

- (1) Select (1) Slider and (2) M8X1.25-35mm Carriage Bolts;
- (2) Install (2) M8X1.25-35mm Carriage Bolts in (1) Slider.
- (3) Slide the Slider (with carriage bolts) to the **Step Bar**.
- (4) Repeat to install the other (1) slider to the step bar.
- (5) Attach the Step Bar (with the Sliders) onto the installed mounting brackets. Position the Sliders to the installed brackets. Secure the Step Bar to the installed Brackets by using (4) M8 Large Flat Washers and (4) M8 Nylon Lock Nuts and (2) Sliders, (Fig 6). Do not fully tighten hardware at this time.

**Note:** The Sliders are packed with the Step Bars.

Level and adjust the Step Bar and fully tighten all hardware.

Repeat **Steps 1-4** for the other side Step Bar installation. **The installation is completed!!!**

### Attention

**Do periodic inspections to the installation to make sure that all hardware is secure and tight.**

**In order to protect your bars/boards, please use mild soap/non-abrasive products for cleaning only.**

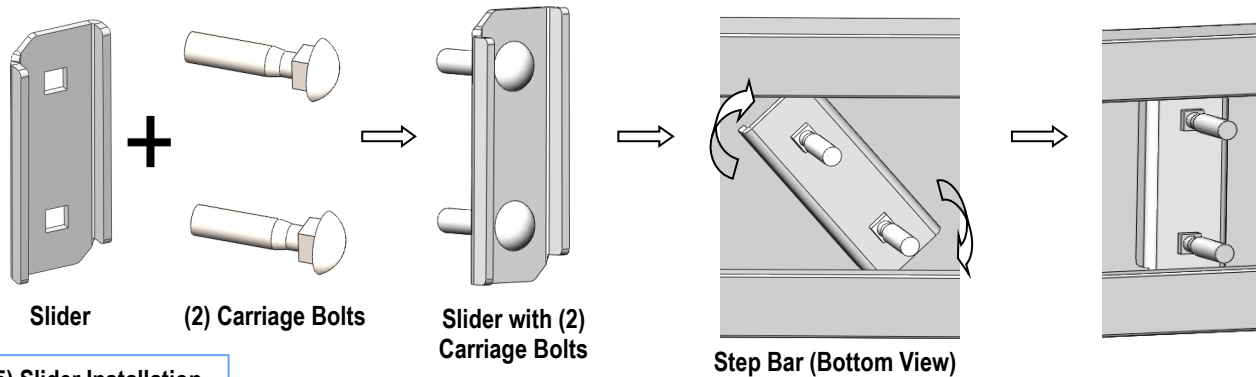

(Fig 5) Slider Installation

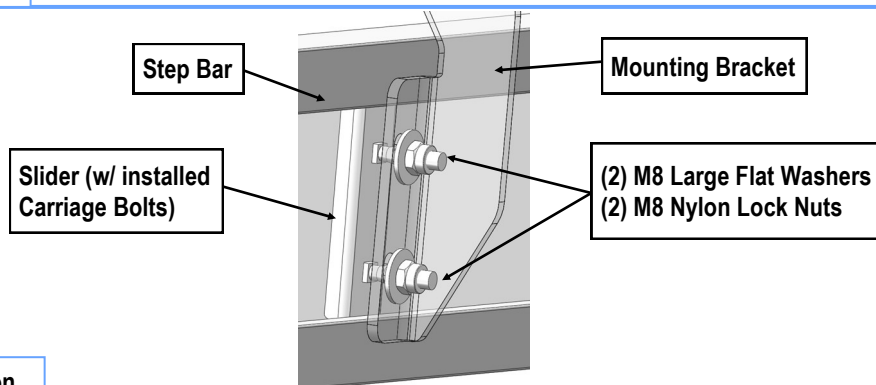

(Fig 6) Step Bar Installation