

iBoard®



Scan for
Installation Video

iBoard® by APS

PART#: IB-231C&H

READ INSTRUCTIONS CAREFULLY BEFORE STARTING INSTALLATION. REMOVE CONTENTS FROM BOX AND VERIFY ALL PARTS ARE PRESENT. ASSISTANCE IS RECOMMENDED.

*ROCKER PANEL MOUNT
*NO DRILLING REQUIRED

Fastener Size	Tightening Torque (ft-lbs)	Required
6mm	6-7	X
8mm	16-18	√
10mm	31-32	X
12mm	56-58	X
14mm	92-94	X

PART LIST

Driver Side Step Bar

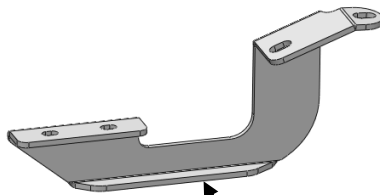
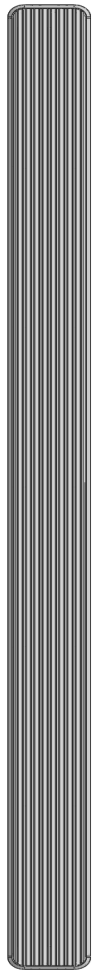

Driver Front Mounting Bracket (DFM)

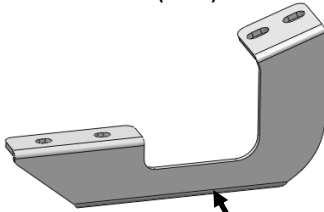

Driver Center Mounting Bracket (DCM)

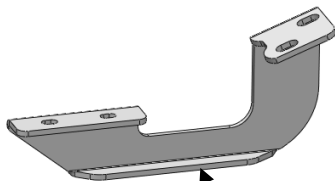

Driver Rear Mounting Bracket (DRM)

Front



Passenger Side Step Bar

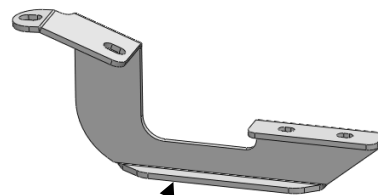
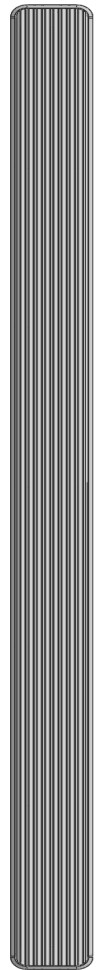

Passenger Front Mounting Bracket (PFM)

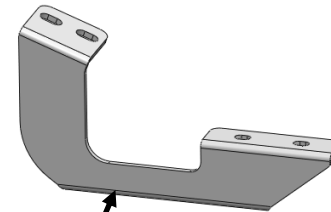

Passenger Center Mounting Bracket (PCM)

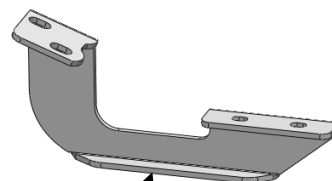

Passenger Rear Mounting Bracket (PRM)

Customer Support: info@iboardauto.com



Scan for
Installation Video

Hardware Package A (For Bracket Installation)

Item	QTY	Description	Item	QTY	Description
1#	12	M8X1.25-30mm Hex Bolts	3#	12	M8 Lock Washers
2#	12	M8 Large Flat Washers			

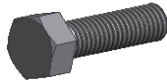

1 #



2 #



3 #

Hardware Package B (For Stainless Steel Step Bar Installation)

Item	QTY	Description	Item	QTY	Description
1#	12	M8X1.25-35mm Carriage Bolts	3#	12	M8 Nylon Lock Nuts
2#	12	M8 Large Flat Washers	4#	6	Sliders (Packed with Step Bars)

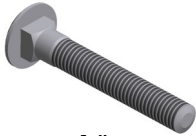

1 #



2 #



3 #

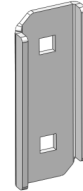

4 #



STEP 1

Start installation from the driver side front of the vehicle. Locate the (2) factory threaded holes in the side panel by the front flare in the body. Partially attach the Driver Front Mounting Bracket (DFM) to the vehicle using the included (2) M8X1.25-30mm Hex Bolts, (2) M8 Lock Washers and (2) M8 Large Flat Washers (Fig 1). Do not fully tighten hardware at this time.

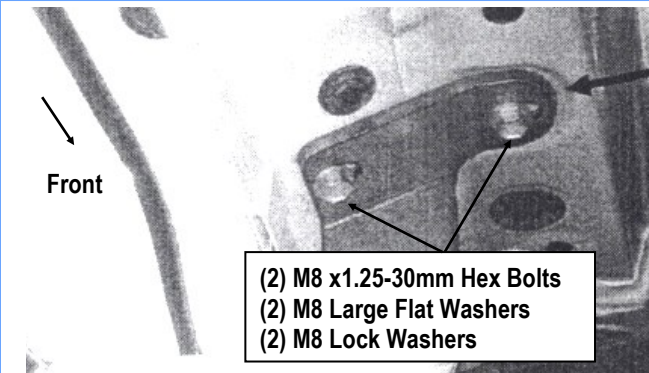

(Fig 1) Driver Side Front Mounting Bracket Installed

STEP 2

Move to the center of the vehicle. There are (2) sets of holes in the side panel between the installed Mounting Brackets, one set by the front Mounting Bracket and the other one by the rear Mounting Bracket. To determine which holes you will be using. Partially install the Driver Center Mounting Bracket (DCM) to the vehicle using the included (2) M8X1.25-30mm Hex Bolts, (2) M8 Lock Washers and (2) M8 Large Flat Washers (Fig 2). Do not fully tighten hardware at this time.

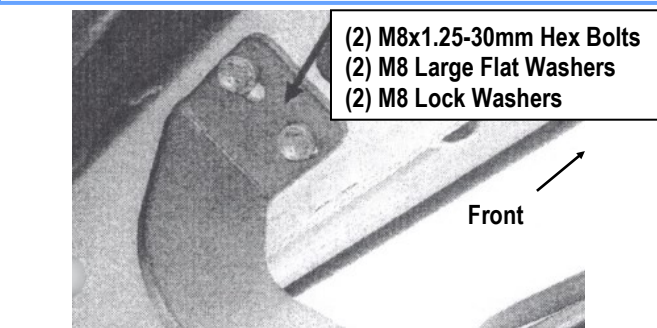

(Fig 2) Driver Side Center Mounting Bracket Installed

STEP 3

Move to the rear of the vehicle. Repeat **Step 1** for Driver Rear Mounting Bracket (DRM) installation, (Fig 3). Do not fully tighten hardware at this time.

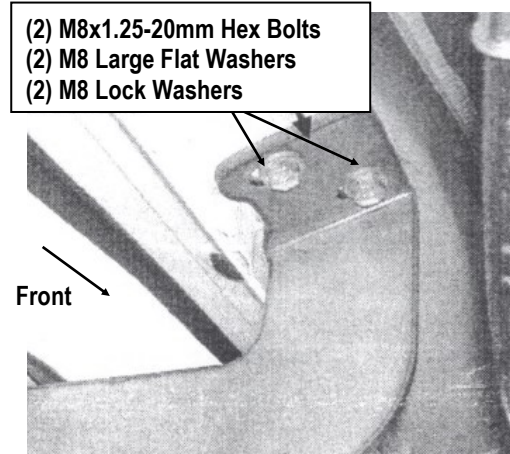

(Fig 3) Driver Side Rear Mounting Bracket Installed

STEP 4

Once all (3) Driver side mounting brackets are installed, then proceed to the Step Bar installation. (Figs 4 & 5)

- (1) Select (1) Slider and (2) M8X1.25-35mm Carriage Bolts;
- (2) Install (2) M8X1.25-35mm Carriage Bolts in (1) Slider.
- (3) Slide the Slider (with carriage bolts) to the **Step Bar**.
- (4) Repeat to install the other (2) sliders to the step bar.
- (5) Attach the Step Bar (with the Sliders) onto the installed mounting brackets. Position the Sliders to the installed brackets. Secure the Step Bar to the installed Brackets by using (6) M8 Large Flat Washers and (6) M8 Nylon Lock Nuts and (3) Sliders, (Fig 5). Do not fully tighten hardware at this time.

Note: The Sliders are packed with the Step Bars.

Level and adjust the Step Bar and fully tighten all hardware. Repeat **Steps 1-4** for the other side Step Bar installation. **The installation is completed!!!**

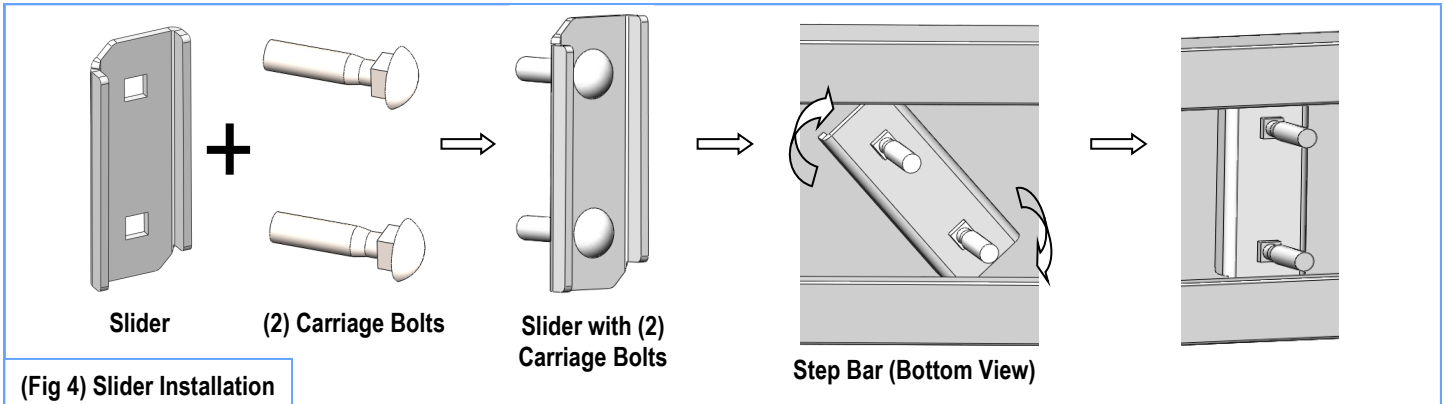

(Fig 4) Slider Installation

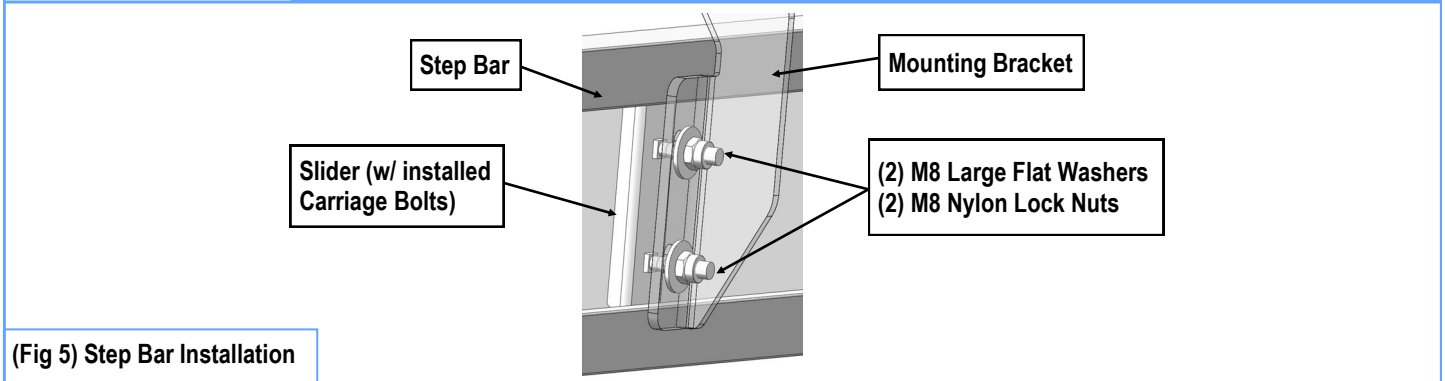

(Fig 5) Step Bar Installation

Attention

Do periodic inspections to the installation to make sure that all hardware is secure and tight.
In order to protect your bars/boards, please use mild soap/non-abrasive products for cleaning only.