



Scan for
Installation Video

PART#: IB-P095/P952Y&H

iBoard® Series

READ INSTRUCTIONS CAREFULLY BEFORE START ING INSTALLATION. REMOVE CONTENTS FROM BOX AND VERIFY ALL PARTS ARE PRESENT. ASSISTANCE IS RECOMMENDED.

Fastener Size	Tightening Torque (ft-lbs)	Required
6mm	6-7	X
8mm	16-18	√
10mm	31-32	X
12mm	56-58	X
14mm	92-94	X

***ROCKER PANEL MOUNT
*NO DRILLING REQUIRED**

PART LIST

Driver Side Step Bar

Front

Passenger Side Step Bar

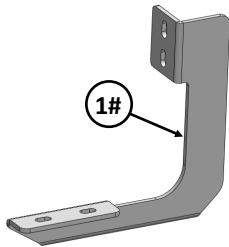

1#

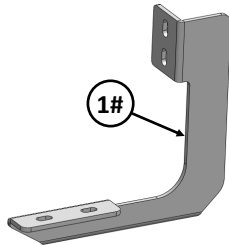

1#

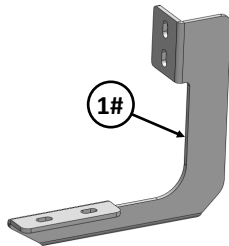

1#

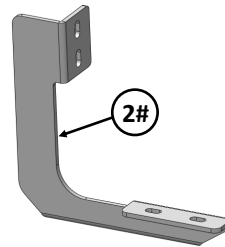

2#

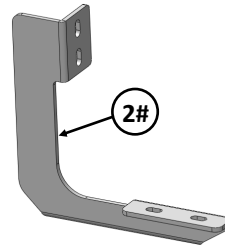

2#

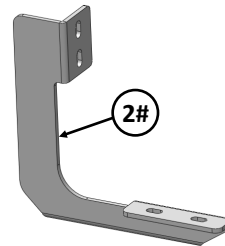



2#



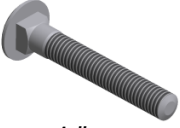

Scan for
Installation Video

Hardware Package A (For Bracket Installation)					
Item	QTY	Description	Item	QTY	Description
1#	3	Driver Side Mounting Brackets	3#	12	M8 Hex Flange Nuts
2#	3	Passenger Side Mounting Brackets			
 3 #					

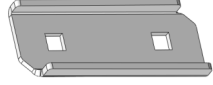
Hardware Package B (For Step Bar Installation)					
Item	QTY	Description	Item	QTY	Description
1#	12	M8X1.25-35mm Carriage Bolts	3#	12	M8 Nylon Lock Nuts
2#	12	M8 Large Flat Washers	4#	6	Sliders (Packed with Mounting Brackets)
    1 # 2 # 3 # 4 #					



STEP 1

Start installation on the driver side of the vehicle. Locate the driver side front bracket mounting location. Select (1) Mounting Bracket, install with (2) M8 Hex Flange Nuts. Do not fully tighten hardware at this time.

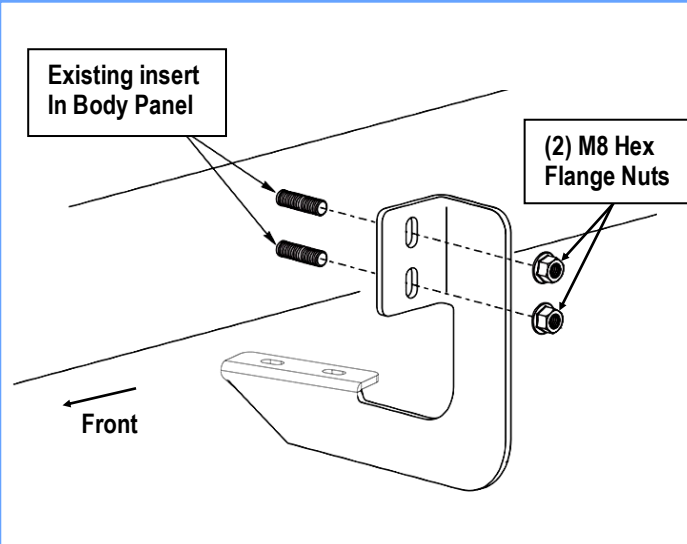

(Fig 1) Driver Side Front Mounting Bracket Installation (Example)

STEP 2

Move to the Driver Side Center & Rear Mounting location. Repeat **Step 1** to install the Driver Side Center & Rear Mounting Bracket.

Note: All (3) Driver Side Mounting Brackets are universal.

STEP 3

Once all (3) Driver side mounting brackets are installed, then proceed to the Step Bar installation. (**Figs 2 & 3**)

- (1) Select (1) Slider and (2) M8X1.25-35mm Carriage Bolts;
- (2) Install (2) M8X1.25-35mm Carriage Bolts in (1) Slider.
- (3) Slide the Slider (with carriage bolts) to the **Step Bar**.
- (4) Repeat to install the other (2) sliders to the step bar.
- (5) Attach the Step Bar (with the Sliders) onto the installed mounting brackets. Position the Sliders to the installed brackets. Secure the Step Bar to the installed Brackets by using (6) M8 Large Flat Washers and (6) M8 Nylon Lock Nuts and (3) Sliders, (**Fig 3**). Do not fully tighten hardware at this time.

Note: The Sliders are packed with the Mounting Brackets.

Level and adjust the Step Bar and fully tighten all hardware.

Repeat **Steps 1-3** for the other side Step Bar installation. **The installation is completed!!!**

Attention

Do periodic inspections to the installation to make sure that all hardware is secure and tight.

In order to protect your bars/boards, please use mild soap/non-abrasive products for cleaning only.

