

iBoard®



Scan for
Installation Video

iBoard® by APS

PART#: IB-096C&H

READ INSTRUCTIONS CAREFULLY BEFORE STARTING INSTALLATION. REMOVE CONTENTS FROM BOX AND VERIFY ALL PARTS ARE PRESENT. ASSISTANCE IS RECOMMENDED.

*ROCKER PANEL MOUNT
*NO DRILLING REQUIRED

Fastener Size	Tightening Torque (ft-lbs)	Required
6mm	6-7	X
8mm	16-18	√
10mm	31-32	X
12mm	56-58	X
14mm	92-94	X

PART LIST

Driver Side Step Bar

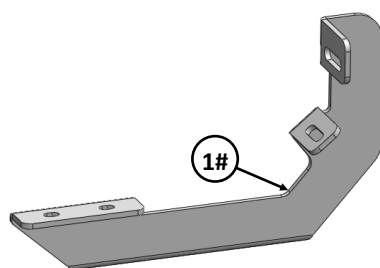
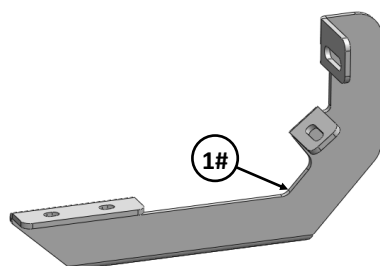

Front



Passenger Side Step Bar

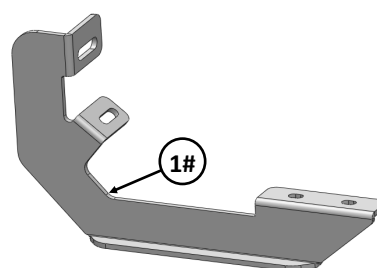
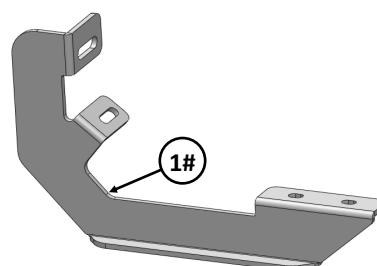
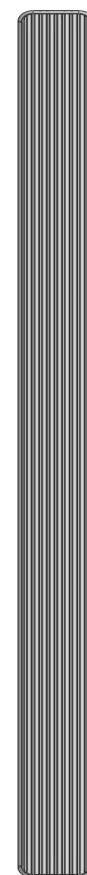



Mounting Bracket List					
Item	QTY	Description	Item	QTY	Description
1#	4	Mounting Brackets			

Hardware Package A (For Bracket Installation)					
Item	QTY	Description	Item	QTY	Description
1#	4	M8X1.25-35mm Hex Bolts	3#	8	M8 Lock Washers
2#	8	M8 Large Flat Washers	4#	4	M8 Hex Nuts



1#



2#



3#



4#

Hardware Package B (For Stainless Steel Step Bar Installation)					
Item	QTY	Description	Item	QTY	Description
1#	8	M8X1.25-35mm Carriage Bolts	3#	8	M8 Nylon Lock Nuts
2#	8	M8 Large Flat Washers	4#	4	Sliders (Packed with Step Bars)

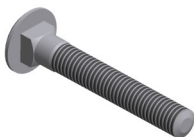

1 #



2 #



3 #

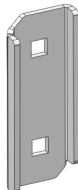

4 #



STEP 1

Start installation from the driver side front of the vehicle. Locate the factory threaded holes or stud located on the side of the inner body panel, (**Fig 1**). **NOTE:** Remove the plastic plug or any insulation on the side panel to locate the threaded holes.

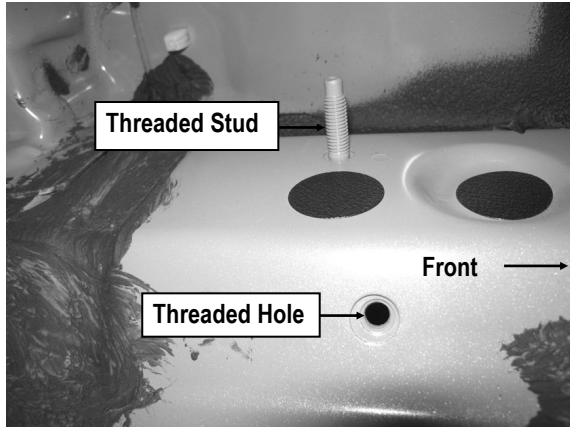

(Fig 1) Driver Side Front Mounting Bracket Location

STEP 2

Select (1) Mounting Bracket. Bolt the Mounting Bracket to the vehicle with (1) M8X1.25-35mm Hex Bolt, (2) M8 Large Flat Washers, (2) M8 Lock Washers and (1) M8 Hex Nut, (**Figs 2 & 3**). Do not fully tighten hardware at this time.

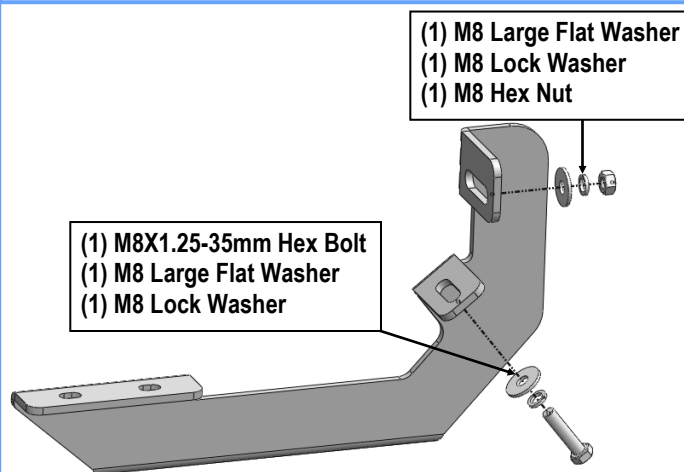

(Fig 2) Driver Side Front Mounting Bracket Installation

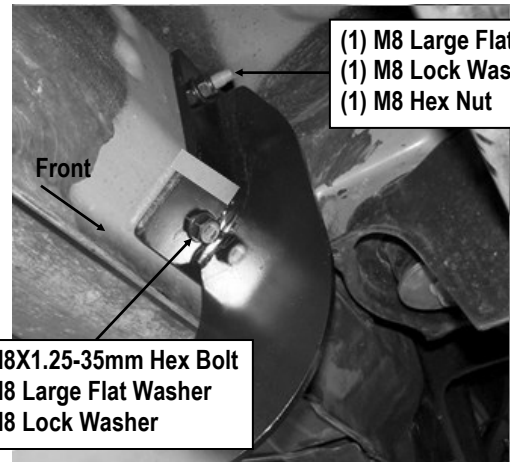

(Fig 3) Driver Side Front Mounting Bracket Installation

STEP 3

Move to the rear mounting location. Repeat **Steps 1 – 2** for Driver Side Rear Mounting Bracket installation. Do not fully tighten hardware at this time.

STEP 4

Once all (2) Driver side mounting brackets are installed, then proceed to the Step Bar installation. (**Figs 4 & 5**)

- (1) Select (1) Slider and (2) M8X1.25-35mm Carriage Bolts;
- (2) Install (2) M8X1.25-35mm Carriage Bolts in (1) Slider.
- (3) Slide the Slider (with carriage bolts) to the **Step Bar**.
- (4) Repeat to install the other (1) slider to the step bar.
- (5) Attach the Step Bar (with the Sliders) onto the installed mounting brackets. Position the Sliders to the installed brackets. Secure the Step Bar to the installed Brackets by using (4) M8 Large Flat Washers and (4) M8 Nylon Lock Nuts and (2) Sliders, (**Fig 5**). Do not fully tighten hardware at this time.

Note: The Sliders are packed with the Step Bars.

Level and adjust the Step Bar and fully tighten all hardware.

Repeat **Steps 1-4** for the other side Step Bar installation. **The installation is completed!!!**

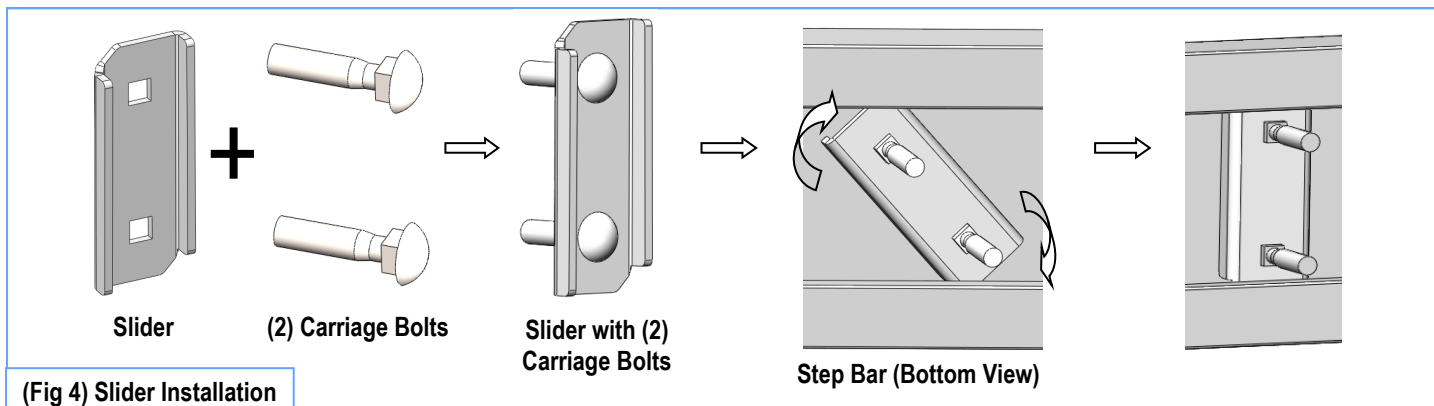

(Fig 4) Slider Installation

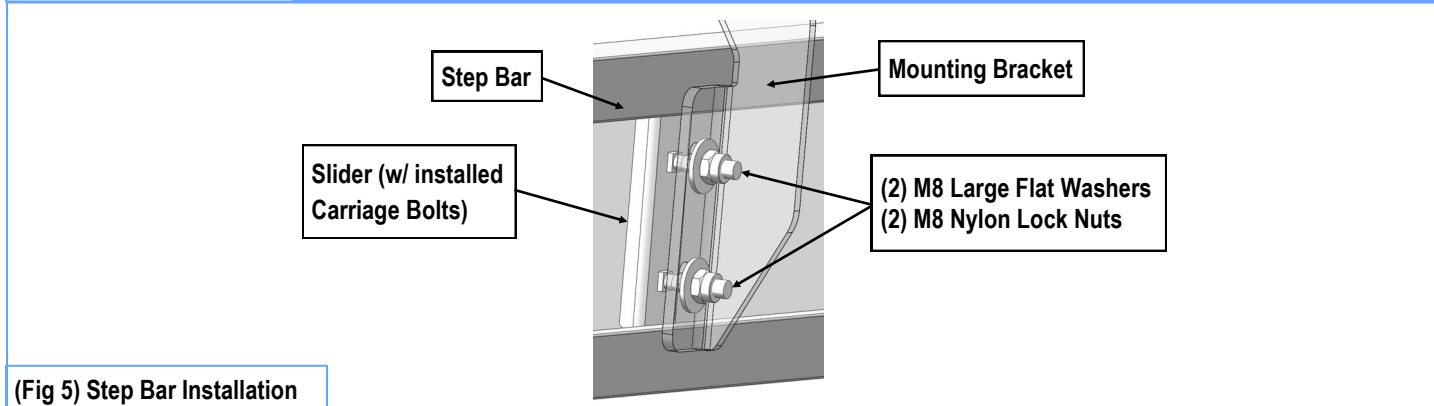

(Fig 5) Step Bar Installation

Attention

Do periodic inspections to the installation to make sure that all hardware is secure and tight.
In order to protect your bars/boards, please use mild soap/non-abrasive products for cleaning only.