

# iBoard®



Scan for  
Installation Video

## iBoard® by APS

PART#: IB-094/095S/095C&H

READ INSTRUCTIONS CAREFULLY BEFORE STARTING INSTALLATION. REMOVE CONTENTS FROM BOX AND VERIFY ALL PARTS ARE PRESENT. ASSISTANCE IS RECOMMENDED.

\*ROCKER PANEL MOUNT  
\*NO DRILLING REQUIRED

Fastener Size	Tightening Torque (ft-lbs)	Required
6mm	6-7	X
8mm	16-18	√
10mm	31-32	X
12mm	56-58	X
14mm	92-94	X

### PART LIST

#### Driver Side Step Bar

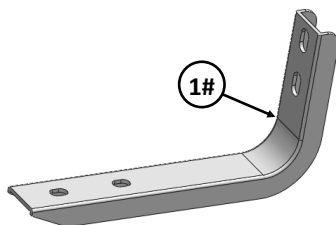
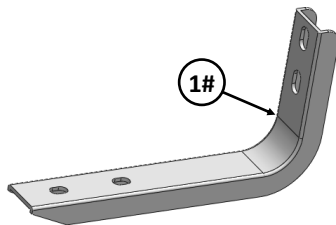
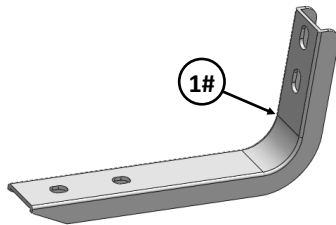
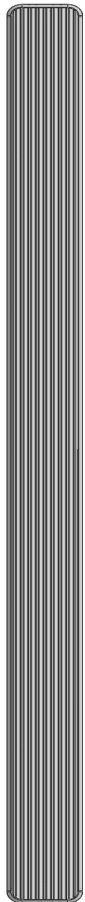

Front



#### Passenger Side Step Bar

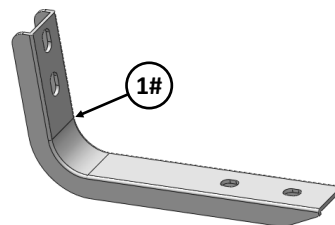
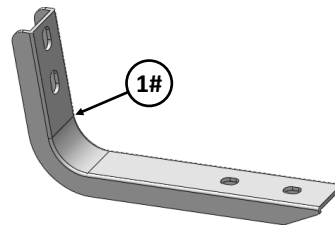
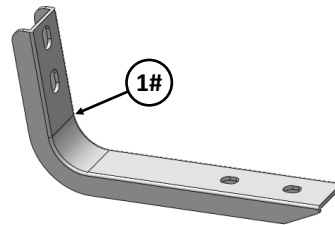

Customer Support: [info@iboardauto.com](mailto:info@iboardauto.com)



Scan for  
Installation Video

Mounting Bracket List					
Item	QTY	Description	Item	QTY	Description
1#	6	Mounting Brackets			

Hardware Package A (For Bracket Installation)					
Item	QTY	Description	Item	QTY	Description
1#	12	M8 Large Flat Washers	3#	12	M8 Hex Nuts
2#	12	M8 Lock Washers			



1 #



2 #

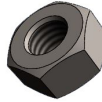

3 #

Hardware Package B (For Stainless Steel Step Bar Installation)					
Item	QTY	Description	Item	QTY	Description
1#	12	M8X1.25-35mm Carriage Bolts	3#	12	M8 Nylon Lock Nuts
2#	12	M8 Large Flat Washers	4#	6	Sliders (Packed with Step Bars)

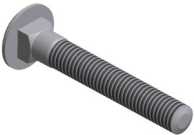

1 #



2 #



3 #

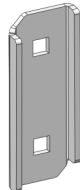

4 #



## STEP 1

Start from the passenger side of the vehicle. On the passenger side, if equipped, remove the existing running board by removing the (6) nuts holding mount to inside of body. Install the mounting brackets with the removed stock nuts, leave nuts loose for now (**Figs 1 & 2**).

**NOTE:** Holes in brackets are off set, install with holes towards front of truck, passenger side shown.

If not equipped with factory running boards – then use the supplied (2) M8 Hex Nuts, (2) M8 Large Flat Washers & (2) M8 Lock Washers to install mounting brackets to truck.

(2) M8 Lock Washers  
(2) M8 Large Flat Washers  
(2) M8 Hex Nuts

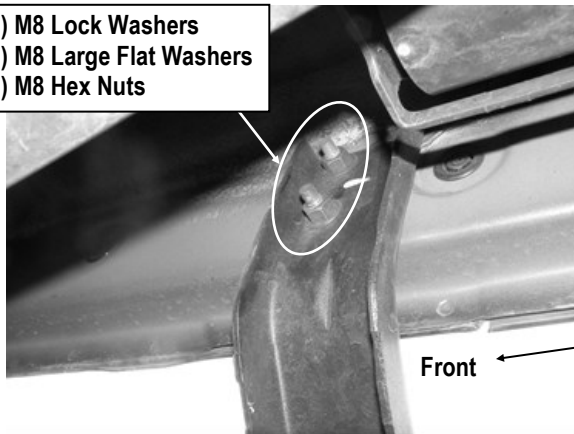

(Fig 1) Passenger Side Front Mounting Bracket

(2) M8 Lock Washers  
(2) M8 Large Flat Washers  
(2) M8 Hex Nuts

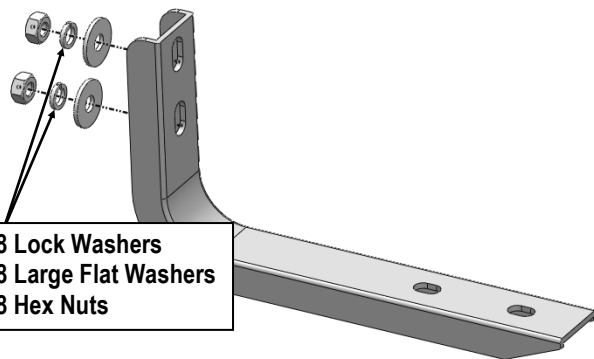

(Fig 2) Passenger Front Mounting Bracket Installation

## STEP 2

Repeat **Step 1** to install other (2) passenger side mounting brackets.

## STEP 3

Once all (3) Passenger side mounting brackets are installed, then proceed to the Step Bar installation. (**Figs 3 & 4**)

(1) Select (1) Slider and (2) M8X1.25-35mm Carriage Bolts;

(2) Install (2) M8X1.25-35mm Carriage Bolts in (1) Slider.

(3) Slide the Slider (with carriage bolts) to the **Step Bar**.

(4) Repeat to install the other (2) sliders to the step bar.

(5) Attach the Step Bar (with the Sliders) onto the installed mounting brackets. Position the Sliders to the installed brackets. Secure the Step Bar to the installed Brackets by using (6) M8 Large Flat Washers and (6) M8 Nylon Lock Nuts and (3) Sliders, (**Fig 4**). Do not fully tighten hardware at this time.

**Note:** The Sliders are packed with the Step Bars.

Level and adjust the Step Bar and fully tighten all hardware.

Repeat **Steps 1-3** for the other side Step Bar installation. **The installation is completed!!!**

Do not fully tighten hardware at this time.

### Attention

**Do periodic inspections to the installation to make sure that all hardware is secure and tight.**

**In order to protect your bars/boards, please use mild soap/non-abrasive products for cleaning only.**



Scan for  
Installation Video

