

# iBoard®



Scan for  
Installation Video

## iBoard® by APS

PART#: IB-049/050C&H

READ INSTRUCTIONS CAREFULLY BEFORE STARTING INSTALLATION. REMOVE CONTENTS FROM BOX AND VERIFY ALL PARTS ARE PRESENT. ASSISTANCE IS RECOMMENDED.

\*ROCKER PANEL MOUNT  
\*NO DRILLING REQUIRED

Fastener Size	Tightening Torque (ft-lbs)	Required
6mm	6-7	X
8mm	16-18	√
10mm	31-32	X
12mm	56-58	X
14mm	92-94	X

### PART LIST

#### Driver Side Step Bar

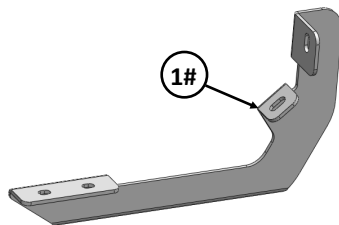
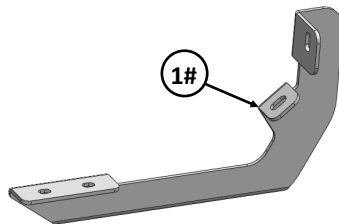
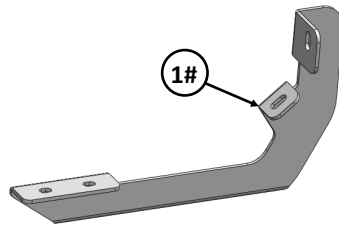
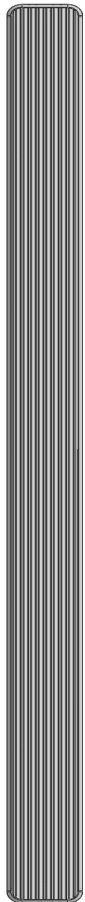

Front



#### Passenger Side Step Bar

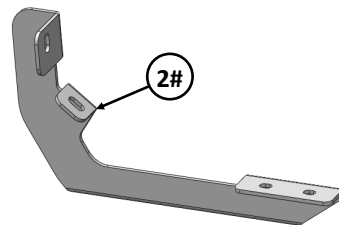
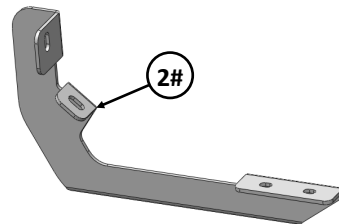
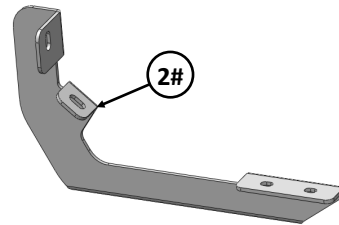

Customer Support: [info@iboardauto.com](mailto:info@iboardauto.com)



Mounting Bracket List					
Item	QTY	Description	Item	QTY	Description
1#	3	Driver Front / Center / Rear Mounting Brackets	2#	3	Passenger Front / Center /Rear Mounting Brackets

Hardware Package A (For Bracket Installation)					
Item	QTY	Description	Item	QTY	Description
1#	12	M8X1.25-30mm Hex Bolts	3#	12	M8 Lock Washers
2#	12	M8 Flat Washers	4#	6	M8X1.25 Nylon Lock Nuts



1 #



2 #



3 #



4 #

Hardware Package B (For Stainless Steel Step Bar Installation)					
Item	QTY	Description	Item	QTY	Description
1#	12	M8X1.25-35mm Carriage Bolts	3#	12	M8 Nylon Lock Nuts
2#	12	M8 Large Flat Washers	4#	6	Sliders (Packed with Step Bars)

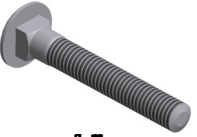

1 #



2 #



3 #

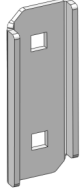

4 #



## STEP 1

Start installation at the driver side of the vehicle and locate the factory threaded holes or stud located on the side of the inner body panel, (Fig 1 & 2).

**NOTE:** Remove the plastic plug or any insulation if equipped.

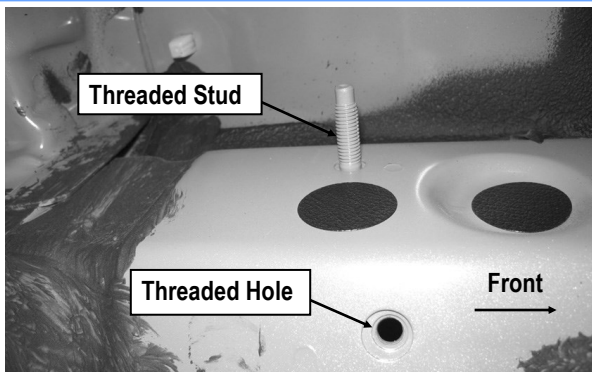

(Fig 1) Up To 2015 Driver Side Rear Mounting Location  
(Note: Remove Plastic Plug If equipped)

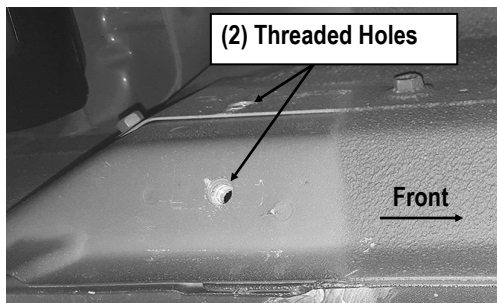

(Fig 2) 2016-On Driver Side Rear Mounting Location  
(Note: Two Factory Threaded Holes Only)

## STEP 2

Attach (1) Driver Front Mounting Bracket onto the Driver Side Front Mounting Location as shown (Fig 3).

- a. **Models with threaded stud:** Attach the Mounting Bracket to stud with (1) M8 Flat Washer, (1) M8 X1.25 Nylon Lock Nut. Next, secure the bracket to the lower threaded hole with (1) M8X1.25-25mm Hex Bolt, (1) M8 Flat Washer and (1) M8 Lock Washer. Do not tighten hardware at this time.
- b. **Models without threaded stud:** Attach the Mounting

Bracket to the upper threaded hole with (1) M8X1.25-25mm Hex Bolt, (1) M8 Flat Washer and (1) M8 Lock Washer. Next, secure the bracket to the lower threaded hole with (1) M8X1.25-25mm Hex Bolt, (1) M8 Flat Washer and (1) M8 Lock Washer, (Fig 4). Do not fully tighten hardware at this time.

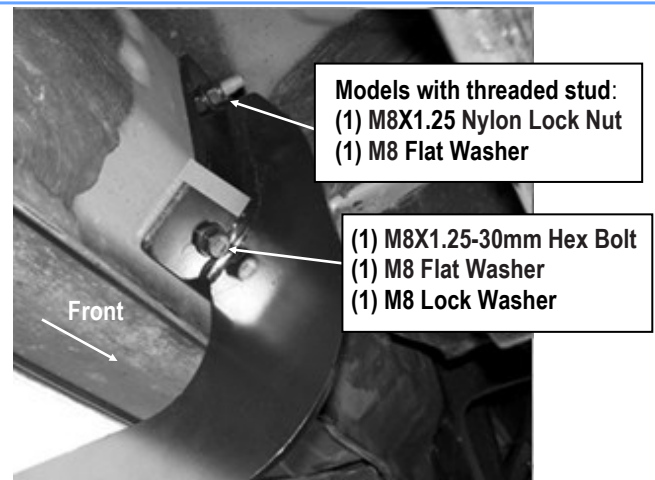

(Fig 3) Models With Threaded Stud Bracket Installed

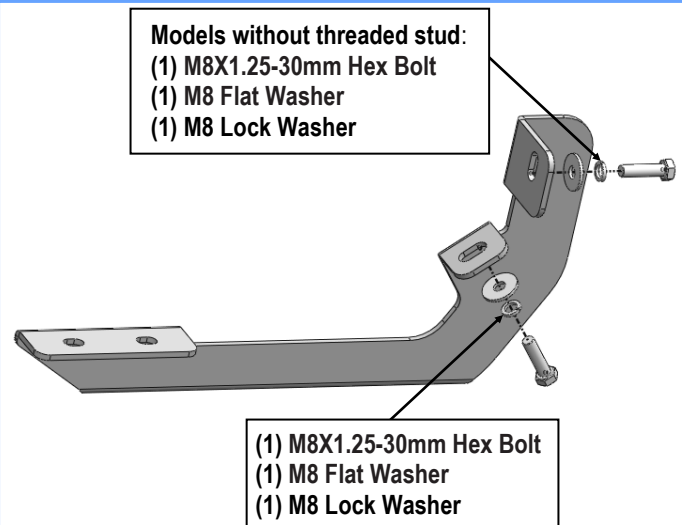

(Fig 4) Models Without Threaded Stud Bracket Installation

## STEP 3

Repeat **Step 1-2** to Install the Driver Center and Rear mounting brackets.



## STEP 4

Once all (3) Driver side mounting brackets are installed, then proceed to the Step Bar installation. **(Figs 5&6)**

- (1) Select (1) Slider and (2) M8X1.25-35mm Carriage Bolts;
- (2) Install (2) M8X1.25-35mm Carriage Bolts in (1) Slider.
- (3) Slide the Slider (with carriage bolts) to the **Step Bar**.
- (4) Repeat to install the other (2) sliders to the step bar.
- (5) Attach the Step Bar (with the Sliders) onto the installed mounting brackets. Position the Sliders to the installed brackets. Secure the Step Bar to the installed Brackets by using (6) M8 Large Flat Washers and (6) M8 Nylon Lock Nuts and (3) Sliders, **(Fig 6)**. Do not fully tighten hardware at this time.

**Note:** The Sliders are packed with the Step Bars.

Level and adjust the Step Bar and fully tighten all hardware.

Repeat **Steps 1-4** for the other side Step Bar installation. **The installation is completed!!!**

### Attention

Do periodic inspections to the installation to make sure that all hardware is secure and tight.

In order to protect your bars/boards, please use mild soap/non-abrasive products for cleaning only.

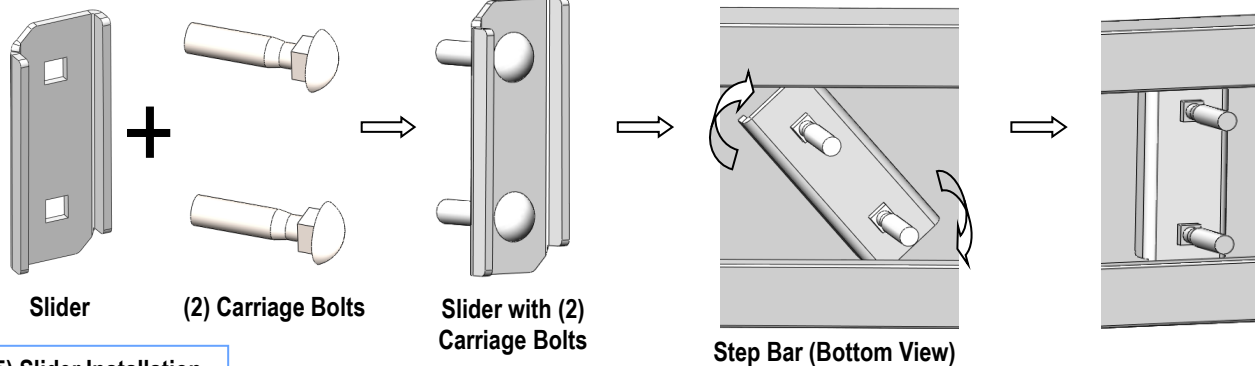

(Fig 5) Slider Installation

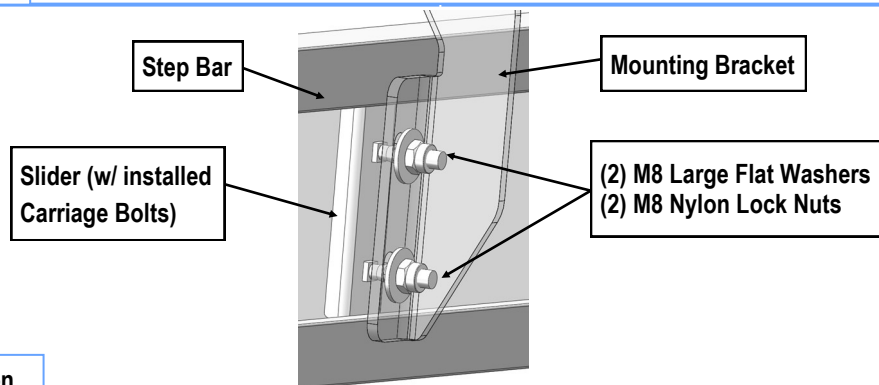

(Fig 6) Step Bar Installation