

# iBoard®



Scan for  
Installation Video

## iBoard® by APS

PART#: IB-120C&H

READ INSTRUCTIONS CAREFULLY BEFORE STARTING INSTALLATION. REMOVE CONTENTS FROM BOX AND VERIFY ALL PARTS ARE PRESENT. ASSISTANCE IS RECOMMENDED.

\*BODY FRAME MOUNT  
\*NO DRILLING REQUIRED

Fastener Size	Tightening Torque (ft-lbs)	Required
6mm	6-7	√
8mm	16-18	√
10mm	31-32	X
12mm	56-58	√
14mm	92-94	X

### PART LIST

Driver Side Step Bar

Front  
↑

Passenger Side Step Bar

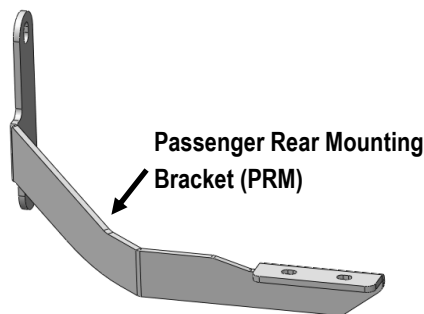
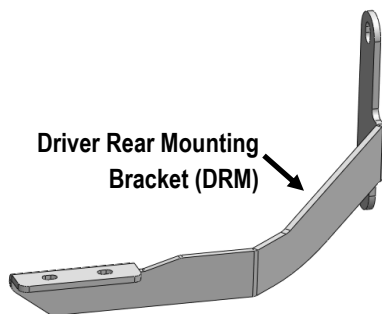
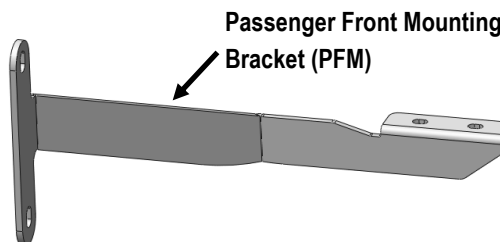
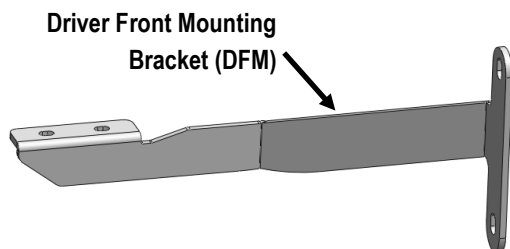
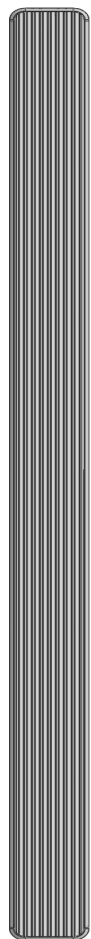







Customer Support: [info@iboardauto.com](mailto:info@iboardauto.com)

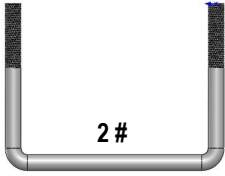



Hardware Package A (For Bracket Installation)					
Item	QTY	Description	Item	QTY	Description
1#	6	Stop Spacers	5#	8	M12 Hex Nuts
2#	4	M12 U-Bolts	6#	3	M6X1-30mm Hex Bolts
3#	8	M12 Large Flat Washers	7#	3	M6 Lock Washers
4#	8	M12 Lock Washers	8#	3	M6 Large Flat Washers

							
1 #	2 #	3 #	4 #	5 #	6 #	7 #	8 #

Hardware Package B (For Stainless Steel Step Bar Installation)					
Item	QTY	Description	Item	QTY	Description
1#	8	M8X1.25-35mm Carriage Bolts	3#	8	M8 Nylon Lock Nuts
2#	8	M8 Large Flat Washers	4#	4	Sliders (Packed with Step Bars)

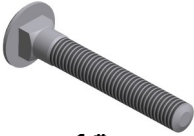

			
1 #	2 #	3 #	4 #

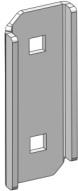

## STEP 1

Start installation from the driver side front of the vehicle. Insert (1) M12 U-Bolt to back plate with as shown, (Figs 1 & 2).

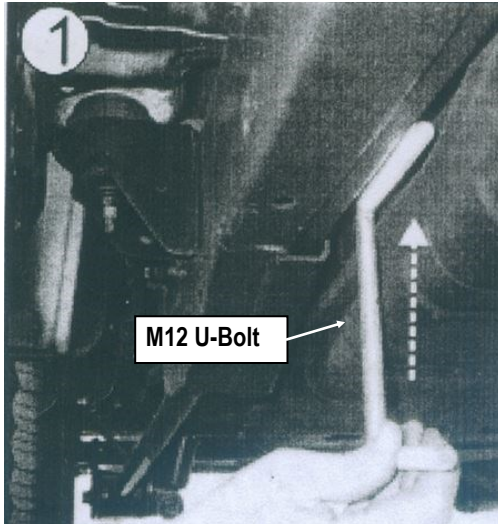

(Fig 1) M12 U-Bolt Installation

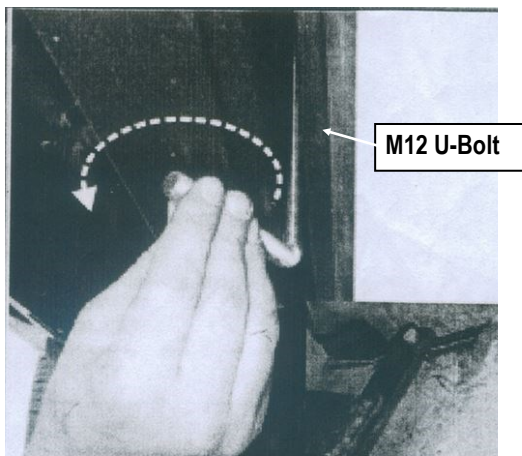

(Fig 2) M12 U-Bolt Installation

## STEP 2

Then, attach (2) Stop Spacers (1) M6X1-30mm Hex Bolt and (1) M6 Lock Washer to the factory hole as shown, (Fig 3).

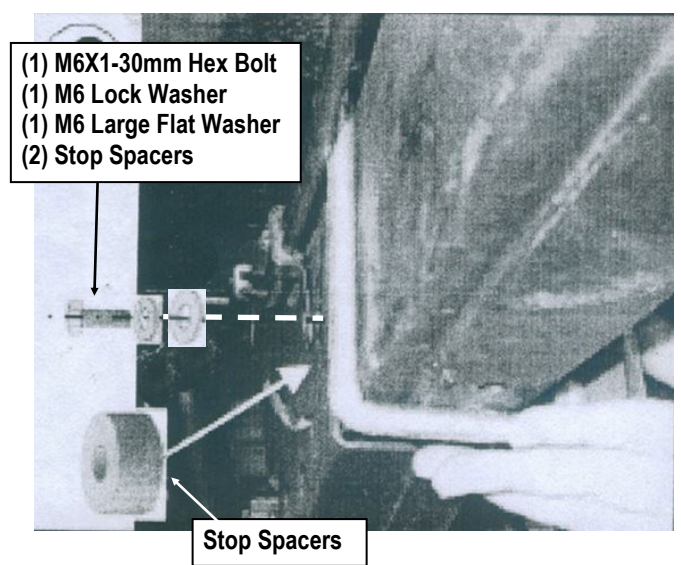

(Fig 3) Stop Spacer Installation

## STEP 3

Attach the Driver Front Mounting Bracket (DFM) to M12 U-Bolt with (2) M12 Large Flat Washers, (2) M12 Lock Washers and (2) M12 Hex Nuts, (Figs 4 & 5). Do not fully tighten hardware at this time.

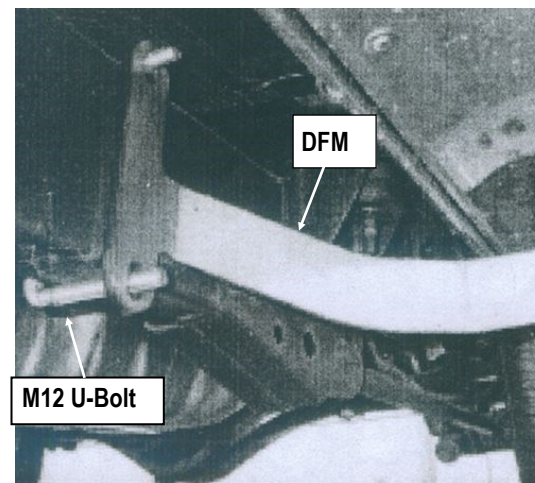

(Fig 4) Driver Front Mounting Bracket Installation

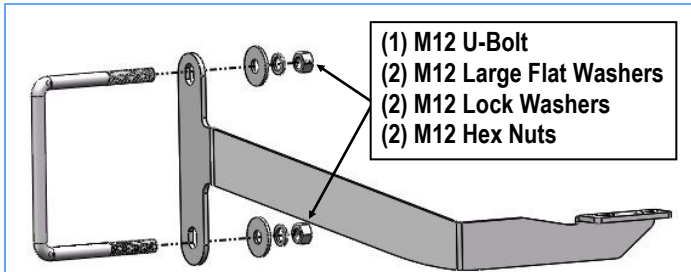

(Fig 5) Driver Front Mounting Bracket Installation

### Attention

Do periodic inspections to the installation to make sure that all hardware is secure and tight.

In order to protect your bars/boards, please use mild soap/non-abrasive products for cleaning only.

## STEP 4

Move to driver side rear mounting location. Repeat **Steps 1-3** for Driver Rear Mounting Bracket (**DRM**) installation. Do not fully tighten hardware at this time.

**Note:** In (4) Mounting Brackets, **only Driver Rear Mounting Bracket do not use Stop Spacer and M6X1-30mm Hex Bolt.**

## STEP 5

Once all (2) Driver side mounting brackets are installed, then proceed to the Step Bar installation. (**Figs 6 & 7**)

- (1) Select (1) Slider and (2) M8X1.25-35mm Carriage Bolts;
- (2) Install (2) M8X1.25-35mm Carriage Bolts in (1) Slider.
- (3) Slide the Slider (with carriage bolts) to the **Step Bar**.
- (4) Repeat to install the other (1) slider to the step bar.
- (5) Attach the Step Bar (with the Sliders) onto the installed mounting brackets. Position the Sliders to the installed brackets. Secure the Step Bar to the installed Brackets by using (4) M8 Large Flat Washers and (4) M8 Nylon Lock Nuts and (2) Sliders, (**Fig 7**). Do not fully tighten hardware at this time.

**Note:** The Sliders are packed with the Step Bars.

Level and adjust the Step Bar and fully tighten all hardware.

Repeat **Steps 1-5** for the other side Step Bar installation. **The installation is completed!!!**

