



iBoard® by APS

PART#: IB-106C&H

READ INSTRUCTIONS CAREFULLY BEFORE STARTING INSTALLATION. REMOVE CONTENTS FROM BOX AND VERIFY ALL PARTS ARE PRESENT. ASSISTANCE IS RECOMMENDED.

*ROCKER PANEL MOUNT
*NO DRILLING REQUIRED

Fastener Size	Tightening Torque (ft-lbs)	Required
6mm	6-7	√
8mm	16-18	√
10mm	31-32	X
12mm	56-58	X
14mm	92-94	X

PART LIST

Driver Side Step Bar

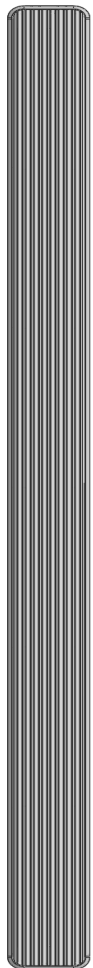

Front



Passenger Side Step Bar

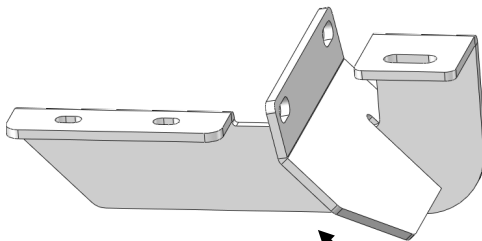
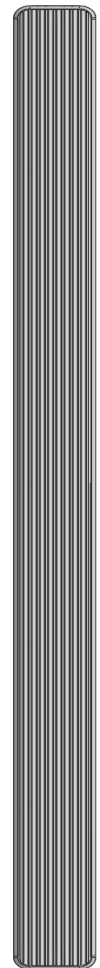

Driver Front Mounting Bracket (DFM)

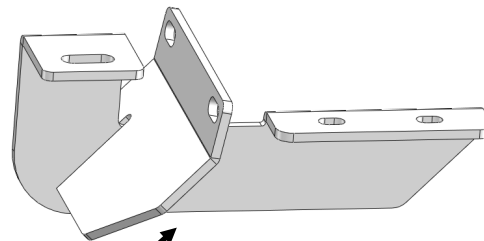

Passenger Front Mounting Bracket (PFM)

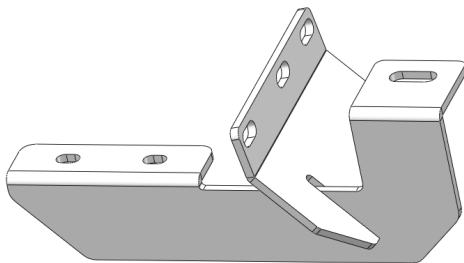

Driver Rear Mounting Bracket (DRM)

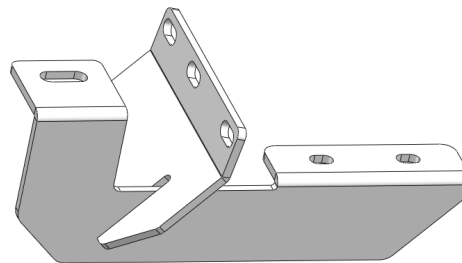

Passenger Rear Mounting Bracket (PRM)



Hardware Package A (For Bracket Installation)

Item	QTY	Description	Item	QTY	Description
1#	4	M8X1.25 Nut Plates	5#	8	M6X1-25mm Inner Hex Bolts
2#	4	M8X1.25-35mm Hex Bolts	6#	8	M6 Large Flat Washers
3#	4	M8 Flat Washers	7#	8	M6 Flat Washers
4#	4	M8 Lock Washers	8#	8	M6X1 Nylon Lock Nuts

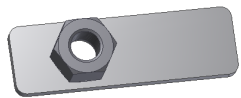

1#

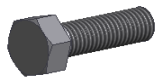

2#



3#



4#



5#



6#



7#



8#

Hardware Package B (For Stainless Steel Step Bar Installation)

Item	QTY	Description	Item	QTY	Description
1#	8	M8X1.25-35mm Carriage Bolts	3#	8	M8 Nylon Lock Nuts
2#	8	M8 Large Flat Washers	4#	4	Sliders (Packed with Step Bars)

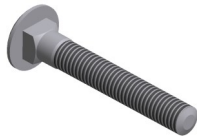

1 #



2 #



3 #



4 #



STEP 1

Start installation toward the front of the driver side of the vehicle. Determine if the vehicle has an open floor panel or a threaded hole in the floor panel for the top tab on the Bracket, **(Figs 1 & 3)**.

Vehicles open mounting location:

Insert (1) M8 Nut Plate into the large square opening in the floor panel. Line up the threaded nut with the small hole in line with the tab on the Bracket, **(Figs 2A & 2B)**. Bolt the Bracket to the Nut Plate with (1) M8X1.25-35mm Hex Bolt, (1) M8 Lock Washer and (1) M8 Flat Washer. Do not fully tighten hardware at this time, **(Fig 4)**.

Vehicles with factory threaded hole in floor panel:

Bolt the tab on the Bracket to the threaded hole in the floor panel with (1) M8X1.25-35mm Hex Bolt, (1) M8 Lock Washer and (1) M8 Flat Washer, **(Figs 3 & 4)**. Do not fully tighten hardware at this time.

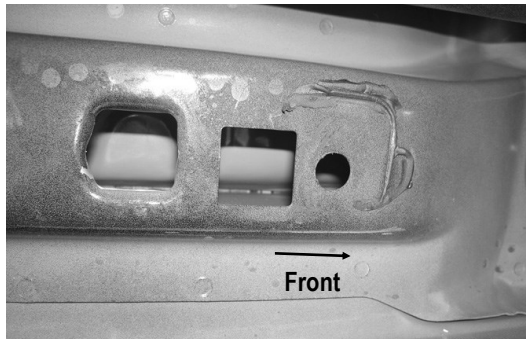

**(Fig 1) Driver Side Front Mounting Location
(Vehicles with open mounting location)**

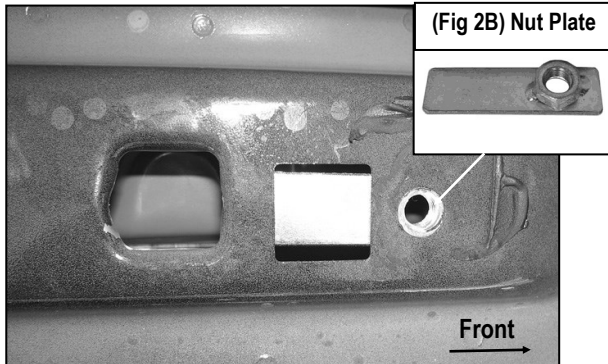

**(Fig 2A) Driver Side Front Mounting Location
(Vehicles with open mounting location)**

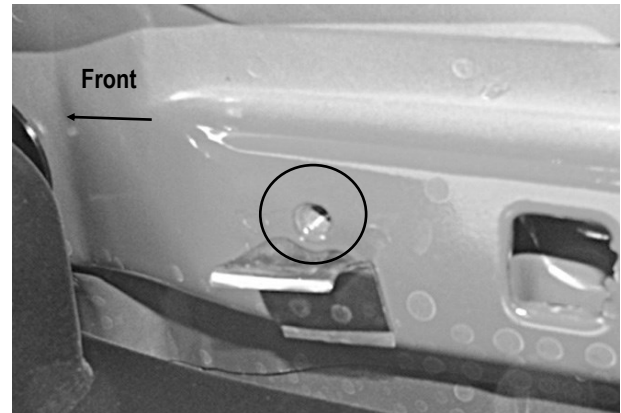

**(Fig 3) Driver Side Front Mounting Location
(Vehicles with factory threaded hole in floor panel)**

STEP 2

Line up the Support Bracket with the (2) factory holes on the pinch weld. Bolt the Support Bracket to the back of the pinch weld using the included (2) M6X1-25mm Inner Hex Bolts, (2) M8 Flat Washers, (against pinch weld), (2) M6 Large Flat Washers, (inside against the bracket) and (2) M6X1 Nylon Lock Nuts, **(Fig 5)**. Do not fully tighten hardware at this time.

Vehicles with open mounting location:

- (1) M8x1.25-35mm Hex Bolt
- (1) M8 Lock Washer
- (1) M8 Flat Washer

Vehicles with factory threaded hole in floor panel:

- (1) M8x1.25-35mm Hex Bolt
- (1) M8 Lock Washer
- (1) M8 Flat Washer

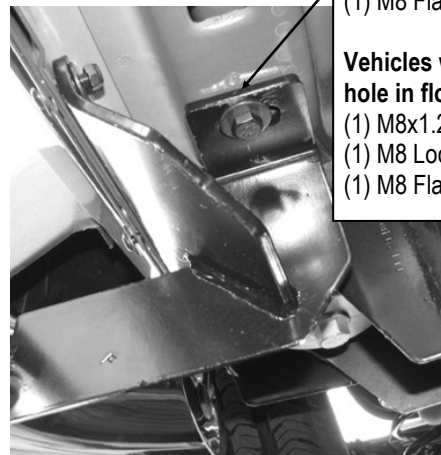

(Fig 4) Driver Front Mounting Bracket Installed



- (2) M6X1-25mm Inner Hex Bolts
- (2) M6 Flat Washers (against pinch weld)
- (2) M6 Large Flat Washers (inside against the bracket)
- (2) M6X1 Nylon Lock Nuts

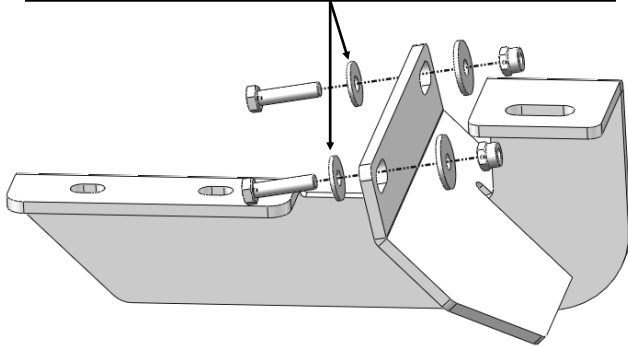

(Fig 5) Driver Front Support Bracket Installation

2007 model uses (1) M6 Bolt in center hole

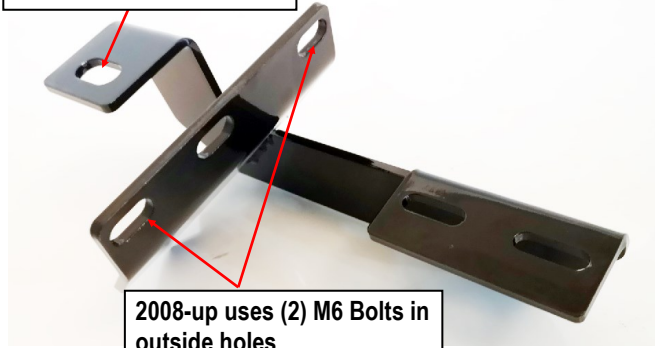

2008-up uses (2) M6 Bolts in outside holes

(Fig 7) Driver Side Rear Mounting Bracket (Example)

STEP 3

Move to the Driver Side Rear Mounting Location, (Fig 6A). Repeat **Steps 1-2** for Driver Rear Mounting Bracket (DRM) installation, (Figs 3 & 6A & 6B).

NOTE: Determine correct Rear Support Bracket installation procedure according to the model year of the vehicle:

A. 2007 Model: Line up the center hole on the Support Bracket to the pinch weld, secure by using (1) M6X1-25mm Inner Hex Bolt, (1) M6 Flat Washer (outside) and (1) M6 Large Flat Washer, (inside against bracket), and (1) M6X1 Nylon Lock Nut to attach rear bracket to the back of the pinch weld, (Figs 7 & 8).

B. 2008-UP Models: Requires (2) M6X1-25mm Inner Hex Bolts, (2) M6 Flat Washers, (outside), (2) M6 Large Flat Washers, (inside against the bracket) and (2) M6X1 Nylon Lock Nuts to attach rear bracket to back of pinch weld, (Figs 7 & 9).

- 2007 Model Uses:
- (1) M6X1-25mm Inner Hex Bolt
 - (1) M6 Flat Washers (outside)
 - (1) M6 Large Flat Washer (inside against the bracket)
 - (1) M6X1 Nylon Lock Nut

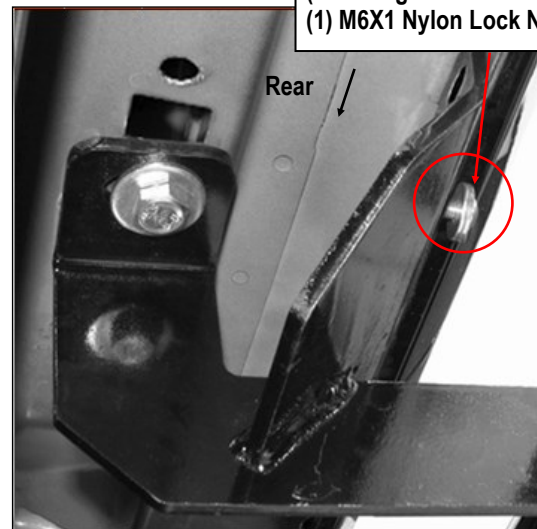

(Fig 8) Driver Rear Support Bracket Installation
(For 2007 Model Only)

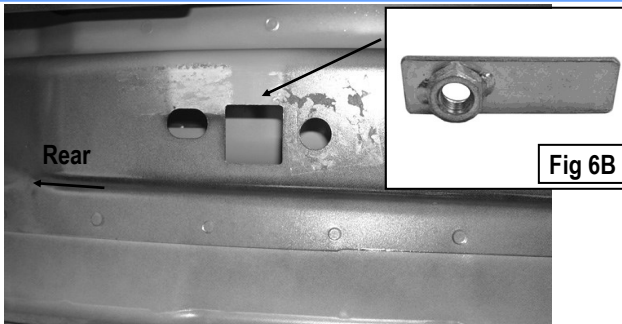

(Fig 6A) Driver Side Rear Mounting Location
(Vehicles with open mounting location)



2008-UP Models Uses:
(2) M6X1-25mm Inner Hex Bolts
(2) M6 Flat Washers (outside)
(2) M6 Large Flat Washers (inside
against the bracket)
(2) M6X1 Nylon Lock Nuts

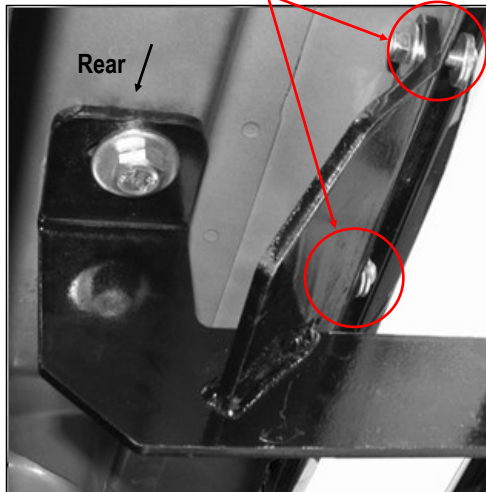

(Fig 9) Driver Rear Support Bracket Installation
(For 08-UP Models)

STEP 4

Once all (2) Driver side mounting brackets are installed, then proceed to the Step Bar installation. (**Figs 10 & 11**)

- (1) Select (1) Slider and (2) M8X1.25-35mm Carriage Bolts;
- (2) Install (2) M8X1.25-35mm Carriage Bolts in (1) Slider.
- (3) Slide the Slider (with carriage bolts) to the **Step Bar**.
- (4) Repeat to install the other (1) slider to the step bar.
- (5) Attach the Step Bar (with the Sliders) onto the installed mounting brackets. Position the Sliders to the installed brackets. Secure the Step Bar to the installed Brackets by using (4) M8 Large Flat Washers and (4) M8 Nylon Lock Nuts and (2) Sliders, (**Fig 11**). Do not fully tighten hardware at this time.

Note: The Sliders are packed with the Step Bars.

Level and adjust the Step Bar and fully tighten all hardware.

Repeat **Steps 1-4** for the other side Step Bar installation. **The installation is completed!!!**

Attention

Do periodic inspections to the installation to make sure that all hardware is secure and tight.
In order to protect your bars/boards, please use mild soap/non-abrasive products for cleaning only.

