

iBoard®

iBoard® by APS

PART#: IB-105

READ INSTRUCTIONS CAREFULLY BEFORE STARTING INSTALLATION. REMOVE CONTENTS FROM BOX AND VERIFY ALL PARTS ARE PRESENT. ASSISTANCE IS RECOMMENDED.

*BODY FRAME MOUNT
*NO DRILLING REQUIRED

Fastener Size	Tightening Torque (ft-lbs)	Required
6mm	6-7	√
8mm	16-18	X
10mm	31-32	√
12mm	56-58	√
14mm	92-94	X

PART LIST

Front
↑

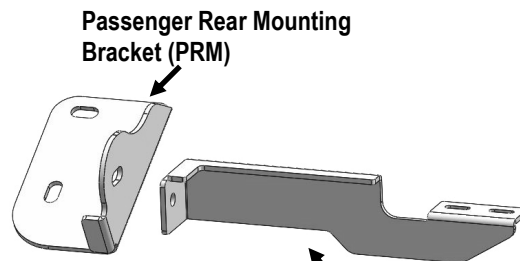
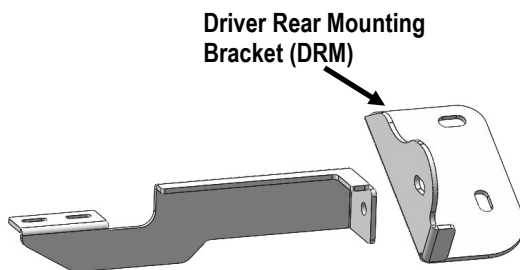
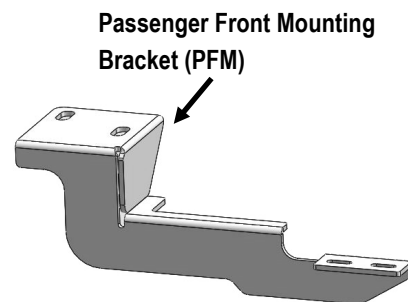
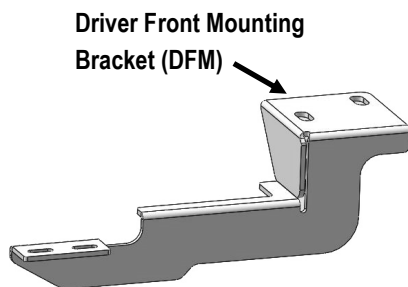

Driver Rear Bar Bracket (DRB)

Passenger Rear Bar Bracket (PRB)

Customer Support: info@iboardauto.com

iBoard®

Hardware Package A (For Bracket Installation)

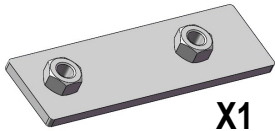

X1
M10 Double Nut Plate

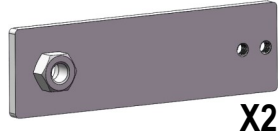

X2
M10 Single Nut Plate



X4
M10X1.5-30mm
Hex Bolt



X2
M10X1.5-25mm
Hex Bolt



X6
M10 Flat Washer



X6
M10 Lock Washer

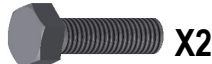

X2
M12X1.75-35mm
Hex Bolt



X4
M12 Flat Washer



X2
M12 Lock Washer

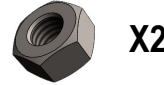

X2
M12 Hex Nut

Hardware Package B (For Aluminum Step Bar Installation Only, Not Supply to Stainless Steel Step Bar)

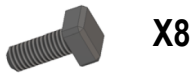

X8
M6X1-20mm Square Head Bolt



X8
M6 Large Flat Washer



X8
M6 Nylon Lock Nut

Hardware Package C (For Stainless Steel Step Bar Installation Only, Not Supply to Aluminum Step Bar)



X8
M6X1-20mm Hex Bolt



X8
M6 Lock Washer



X8
M6 Flat Washer

STEP 1

Start installation from the driver side front of the vehicle. Locate the Driver Front Mounting Bracket (DFM) location, (Fig 1A).

Select (1) M10 Double Nut Plate, (Fig 1B). Insert the M10 Double Nut Plate into the large round hole in the floor panel. Line up the (2) threaded nuts on the M10 Double Nut Plate with the large round hole and the oval hole on the floor panel.

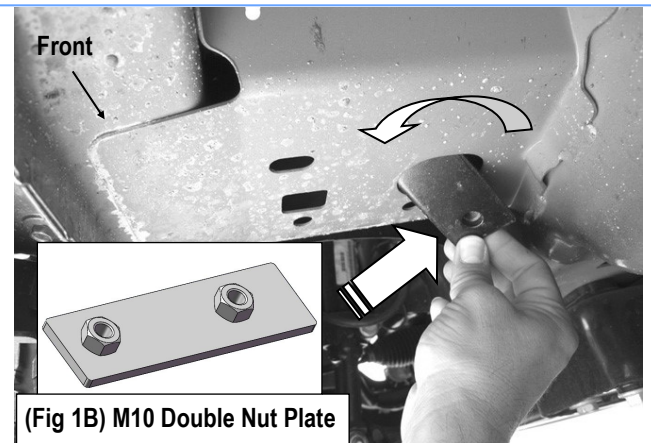

(Fig 1A) M10 Double Nut Plate Installation
Driver Front Mounting Bracket (DFM) Location

iBoard®

STEP 2

Select the Driver Front Mounting Bracket (**DFM**). Attach the Bracket to the installed M10 Double Nut Plate with (2) M10X1.5-30mm Hex Bolts, (2) M10 Lock Washers and (2) M10 Flat Washers (**Fig 2**). Do not fully tighten hardware at this time.

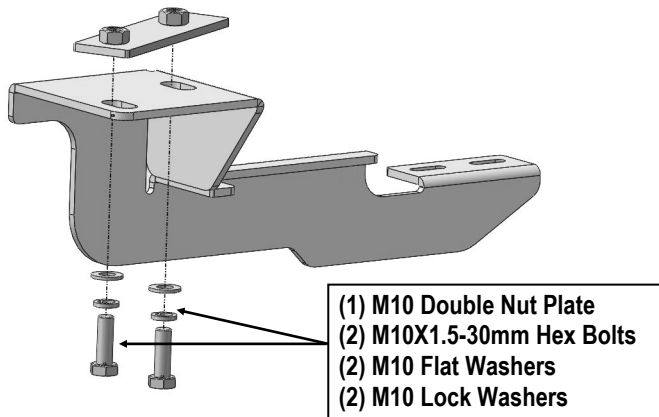

(Fig 2) Driver Front Mounting Bracket (DFM) Installation

STEP 3

Next, move to the driver side rear of the vehicle. Assemble (1) Driver Rear Mounting Bracket (**DRM**) and (1) Driver Rear Bar Bracket (**DRB**) with (1) M12X1.75-35mm Hex Bolt, (2) M12 Flat Washers, (1) M12 Lock Washer and (1) M12 Hex Nut, (**Fig 3**). Do not fully tighten hardware at this time.

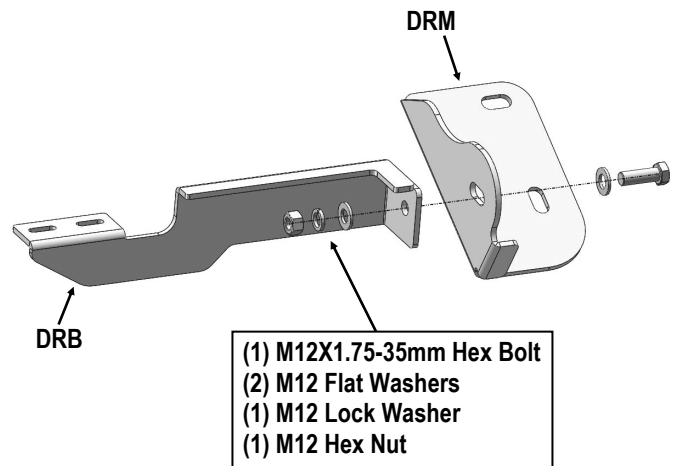

(Fig 3) Driver Rear Mounting Bracket Assembly

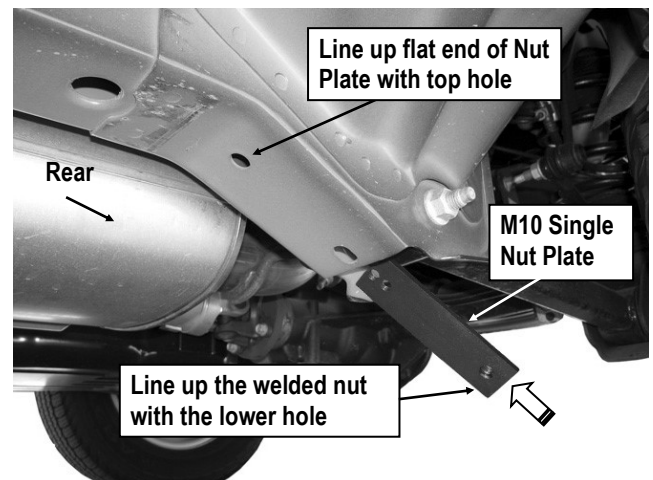

(Fig 4) M10 Single Nut Plate Installation
(On the Driver Side Rear Mounting Location)

STEP 4

Locate the Driver Side Rear Mounting Location, (**Fig 4**). Select (1) M10 Single Nut Plate, insert the flat end of the M10 Single Nut Plate (No welded nut) into the frame. Line up the threaded holes and welded nut on the M10 Single Nut Plate with the (2) holes on the frame, (**Fig 4**).

NOTE: Make sure the welded nut side of the Nut Plate is facing up.

STEP 5

Next, attach the assembled Driver Rear Mounting Bracket (**DRM**) to M10 Single Nut Plate with (1) M10X1.5-30mm Hex Bolt (lower nut plate hole), (1) M10X1.5-25mm Hex Bolt (top nut plate hole), (2) M10 Lock Washers, and (2) M10 Flat Washers, (**Fig 5**). Do not fully tighten hardware at this time.

iBoard®

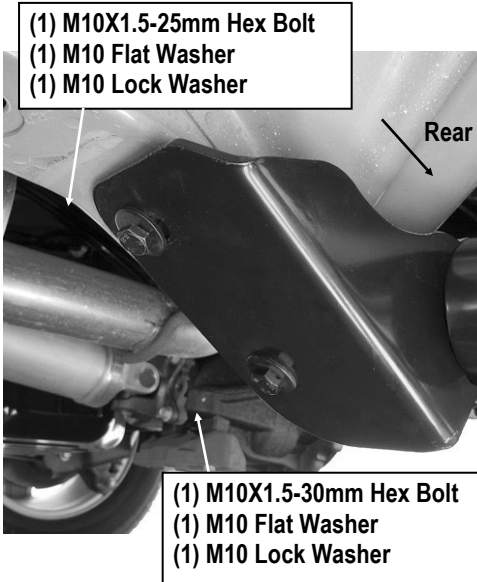

(Fig 5) Driver Rear Mounting Bracket (DFM) Installation

STEP 6

Once all (2) mounting brackets are installed, then proceed to the Step Bar installation. According to the style of Step Bar proceed to the correct installation STEPS.

Note: Aluminum Step Bar refer to STEP 7; Stainless Steel Step Bar skip to STEP 8.

STEP 7

Aluminum Step Bar Installation:

Select a **Aluminum Step Bar**. Slip (2) M6x1-20mm Square Head Bolts into each bottom channel (Fig 6). Carefully position the Step Bar onto the (2) Mounting Brackets.

IMPORTANT: Do not slide the Step Bar on the Brackets or the bottom surface of the board will be damaged. Attach the Step Bar to each Mounting Brackets with (2) M6x1-20mm Square Head Bolts, (2) M6 Large Flat Washers and (2) M6 Nylon Lock Nuts, (Fig 7). Do not fully tighten at this time.



(Fig 6) Slip M6X1-20mm Square Head Bolts Into The Bottom Channels

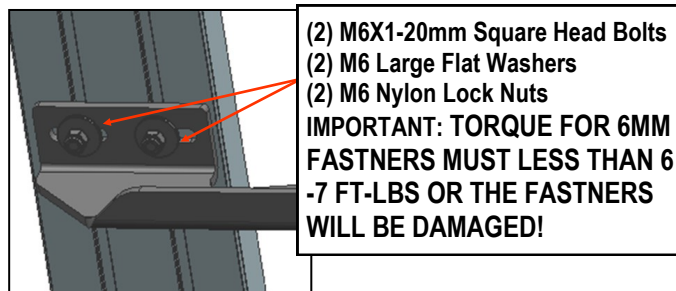

(Fig 7) Running Board Installed Onto Mounting Bracket

STEP 8

Stainless Steel Step Bar Installation:

Select a **Stainless Steel Step Bar** (with the U-Sliders installed on the Bar). Loose the U-Sliders, reposition the U-Sliders onto the board according to the (2) Installed Mounting Brackets location, (Fig 8). Re-secure the U-Sliders on the Step Bar. Attach the Step Bar to the installed Mounting Brackets with (4) M6X1-20mm Hex Bolts, (4) M6 Large Flat Washers & (4) M6 Lock Washers, (Fig 9). Do not fully tighten hardware at this time.

iBoard®



(Fig 8) Slide & line up the U-Slider with the installed mounting brackets along bottom channel

(2) M6X1-20mm Hex Bolts
(2) M6 Large Flat Washers
(2) M6 Lock Washers
IMPORTANT: TORQUE FOR 6MM FASTNERS MUST LESS THAN 6-7 FT-LBS OR THE FASTNERS WILL BE DAMAGED!

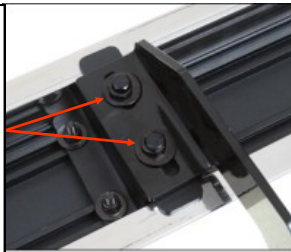

(Fig 9) Step Bar Installed on Bracket Installed (Example)

STEP 9

Level and adjust the Running Board as necessary and fully tighten all hardware.

STEP 10

Move to the passenger side of the vehicle. Remove the (2) Factory Hex Bolts on the cover over the air conditioning lines located by the front fender, (Fig 10). Hold the Passenger Front Mounting Bracket (PFM) in position over the (2) holes and secure it with the (2) Factory Hex Bolts. Do not fully tighten hardware at this time.

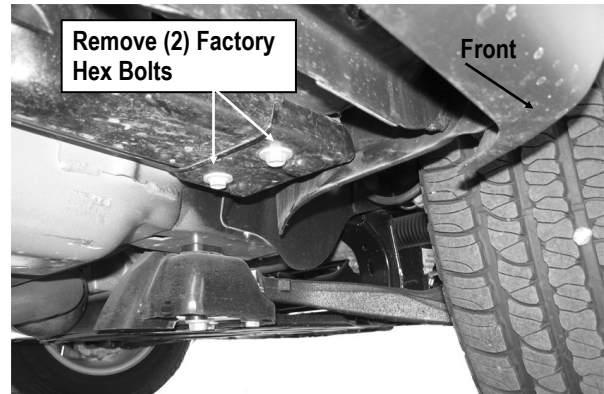

(Fig 10) Passenger Side Front Mounting Location

STEP 11

Repeat **Steps 3-5** for Passenger Rear Mounting Bracket (PRM) and Passenger Rear Bar Bracket (PRB) assembly and installation. Do not fully tighten hardware at this time.

STEP 12

Repeat **Steps 6-9** for the passenger side Running Board installation. The installation is completed.

Attention

Do periodic inspections to the installation to make sure that all hardware is secure and tight.

In order to protect your bars/boards, please use only mild soap/non-abrasive products for cleaning.