

# iBoard®



Scan for  
Installation Video

## iBoard® by APS

PART#: IB-124C&H

READ INSTRUCTIONS CAREFULLY BEFORE STARTING INSTALLATION. REMOVE CONTENTS FROM BOX AND VERIFY ALL PARTS ARE PRESENT. ASSISTANCE IS RECOMMENDED.

\*ROCKER PANEL MOUNT  
\*NO DRILLING REQUIRED

Fastener Size	Tightening Torque (ft-lbs)	Required
6mm	6-7	X
8mm	16-18	√
10mm	31-32	X
12mm	56-58	X
14mm	92-94	X

### PART LIST

#### Driver Side Step Bar

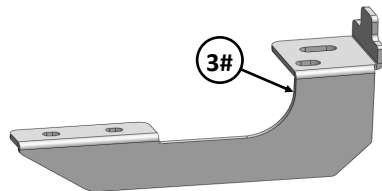
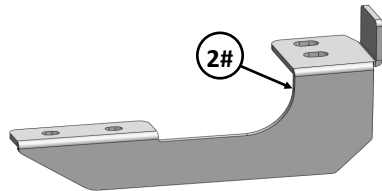
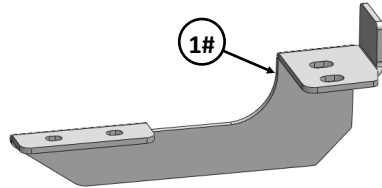
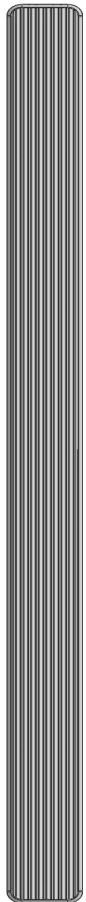

#### Front

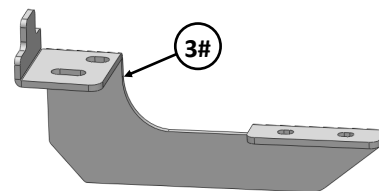
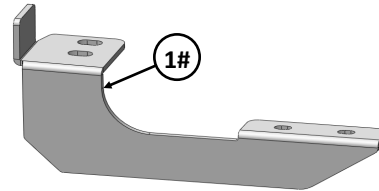
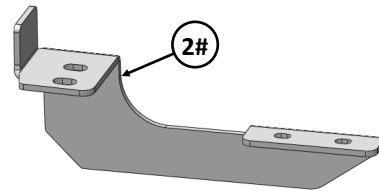

#### Passenger Side Step Bar

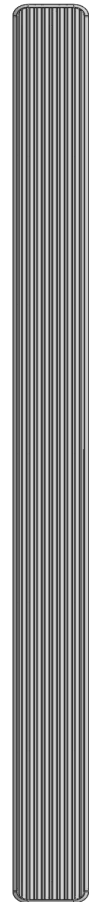





Scan for  
Installation Video

Mounting Bracket List					
Item	QTY	Description	Item	QTY	Description
1#	2	Driver Front / Passenger Center Mounting Brackets	3#	2	Driver / Passenger Rear Mounting Brackets
2#	2	Passenger Front / Driver Center Mounting Brackets			

Hardware Package A (For Bracket Installation)					
Item	QTY	Description	Item	QTY	Description
1#	12	M8X1.25-30mm Hex Bolts	3#	12	M8 Lock Washers
2#	12	M8 Large Flat Washers			



1#



2#



3#

Hardware Package B (For Stainless Steel Step Bar Installation)					
Item	QTY	Description	Item	QTY	Description
1#	12	M8X1.25-35mm Carriage Bolts	3#	12	M8 Nylon Lock Nuts
2#	12	M8 Large Flat Washers	4#	6	Sliders (Packed with Step Bars)

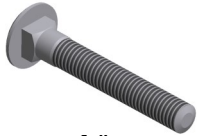

1 #



2 #



3 #

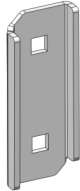

4 #



## STEP 1

Starting on the driver side of the vehicle. Locate the (2) factory threaded holes in the bottom of the outer frame channel, (**Fig 1**).

**NOTE:** The threaded holes may be filled with plastic plugs or covered in insulation. Remove plugs or insulation before proceeding. There may be (4) sets of threaded holes along the floor panel. This installation will use the first, third and fourth sets of holes only.

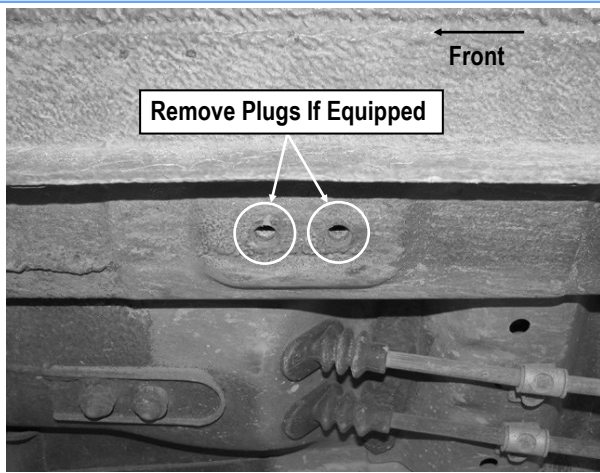

(Fig 1) Driver Side Front Mounting Location

## STEP 2

Start from the driver front mounting location, (**Fig 1**). Bolt the Driver Front Mounting Bracket to the factory threaded holes with (2) M8X1.25-30mm Hex Bolts, (2) M8 Flat Washers and (2) M8 Lock Washers, (**Fig 2**). Do not fully tighten hardware at this time.

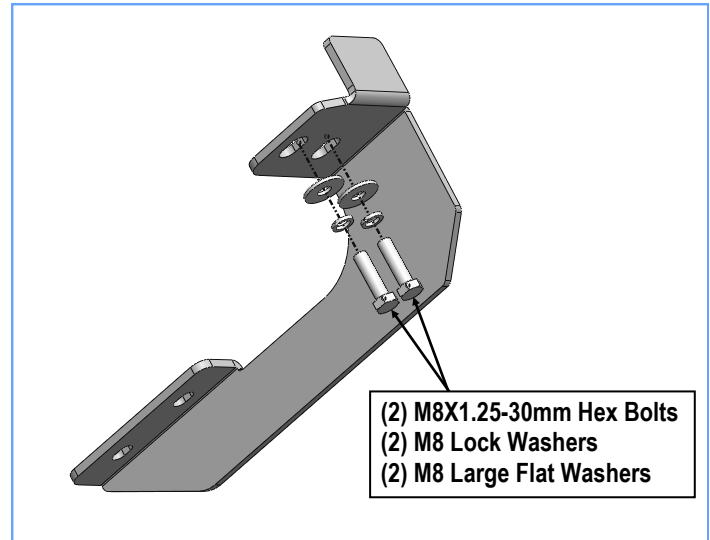

(Fig 2) Driver Front Mounting Bracket Installation

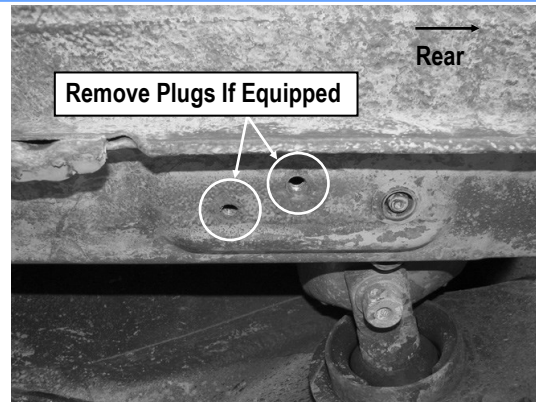

(Fig 3) Driver Side Rear Mounting Location

## STEP 3

Move to driver side center & rear mounting location, (**Fig 3**). Repeat **Step 2** to bolt the Driver Center Mounting Bracket & Driver Rear Mounting Bracket to the factory threaded holes. Do not fully tighten hardware at this time.



## STEP 4

Once all (3) Driver side mounting brackets are installed, then proceed to the Step Bar installation. (Figs 4 & 5)

- (1) Select (1) Slider and (2) M8X1.25-35mm Carriage Bolts;
- (2) Install (2) M8X1.25-35mm Carriage Bolts in (1) Slider.
- (3) Slide the Slider (with carriage bolts) to the **Step Bar**.
- (4) Repeat to install the other (2) sliders to the step bar.
- (5) Attach the Step Bar (with the Sliders) onto the installed mounting brackets. Position the Sliders to the installed brackets. Secure the Step Bar to the installed Brackets by using (6) M8 Large Flat Washers and (6) M8 Nylon Lock Nuts and (3) Sliders, (Fig 5). Do not fully tighten hardware at this time.

**Note:** The Sliders are packed with the Step Bars.

Level and adjust the Step Bar and fully tighten all hardware.

Repeat **Steps 1-4** for the other side Step Bar installation. **The installation is completed!!!**

### Attention

**Do periodic inspections to the installation to make sure that all hardware is secure and tight.**

**In order to protect your bars/boards, please use mild soap/non-abrasive products for cleaning only.**

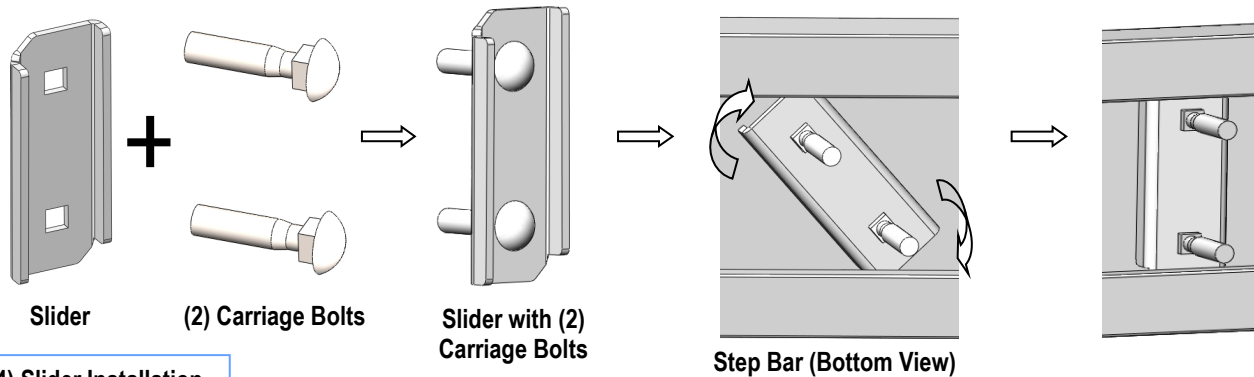

(Fig 4) Slider Installation

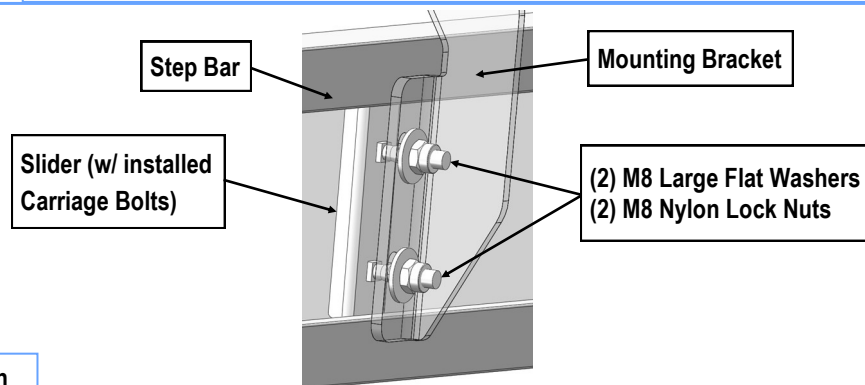

(Fig 5) Step Bar Installation