

# iBoard®

## iBoard® by APS

PART#: IB-123

READ INSTRUCTIONS CAREFULLY BEFORE STARTING INSTALLATION. REMOVE CONTENTS FROM BOX AND VERIFY ALL PARTS ARE PRESENT. ASSISTANCE IS RECOMMENDED.

\*ROCKER PANEL MOUNT  
\*NO DRILLING REQUIRED

Fastener Size	Tightening Torque (ft-lbs)	Required
6mm	6-7	√
8mm	16-18	√
10mm	31-32	√
12mm	56-58	X
14mm	92-94	X

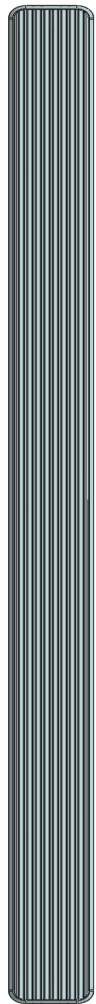

Driver Side Step Bar

Front  
↑

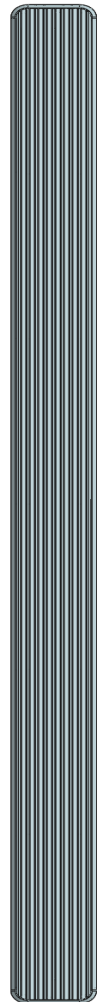
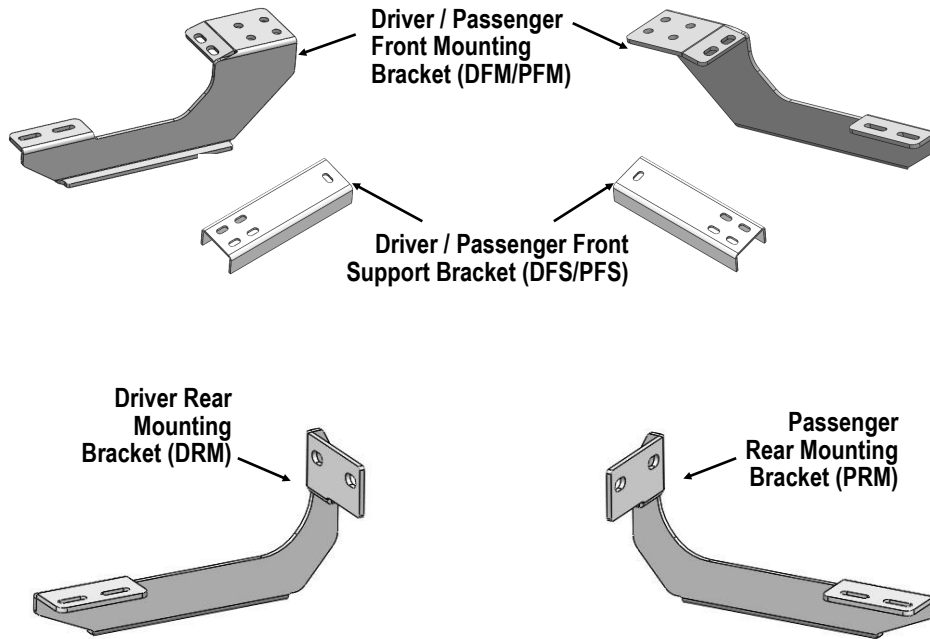



Passenger Side Step Bar

# iBoard®

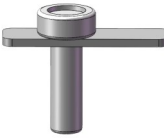
Hardware Package A (For Bracket Installation)					
Item	QTY	Description	Item	QTY	Description
1#	4	M10X1.5-35mm Bolt Plates	6#	8	M8X1.25-20mm Hex Flange Bolts
2#	4	M10 Plastic Washers	7#	8	M8X1.25 Hex Flange Nuts
3#	4	M10 Flat Washers	8#	6	M8X1.25-30mm Hex Bolts
4#	4	M10 Lock Washers	9#	6	M8 Large Flat Washers
5#	4	M10X1.5 Hex Nuts	10#	6	M8 Lock Washers

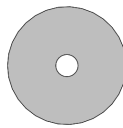
 1#

 2#

 3#

 4#

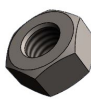
 5#

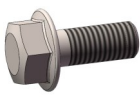
 6#

 7#

 8#

 9#

 10#

Hardware Package B (For Aluminum Step Bar Installation Only, Not Supply to SS. Step Bar)					
Item	QTY	Description	Item	QTY	Description
1#	8	M6X1-20mm Square Head Bolts	3#	8	M6X1 Nylon Lock Nuts
2#	8	M6 Large Flat Washers			

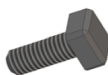
 1 #

 2 #

 3 #

Hardware Package C (For Stainless Steel Step Bar Installation Only, Not Supply to Aluminum Step Bar)					
Item	QTY	Description	Item	QTY	Description
1#	8	M6X1-20mm Hex Bolts	3#	8	M6 Flat Washers
2#	8	M6 Lock Washers			

 1 #

 2 #

 3 #

# iBoard®

## STEP 1

Starting from the driver side of the vehicle, locate the (2) factory threaded holes at the bottom of the outer frame channel and the single threaded hole at the bottom of the inner frame channel, (Fig 1A & 1B).

**NOTE:** The threaded holes may be covered with plastic plugs or covered in insulation. Remove plugs or insulation before proceeding.

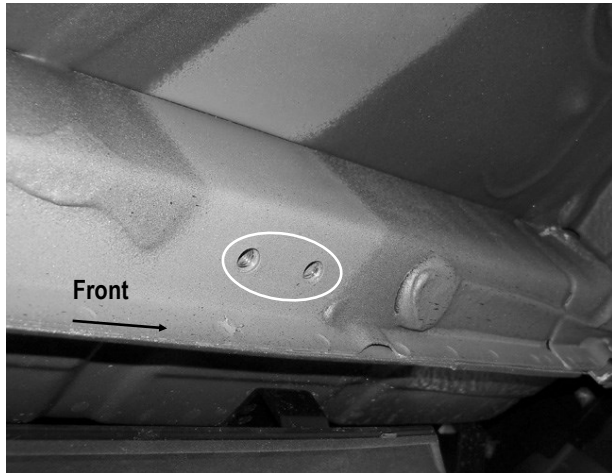

(Fig 1A) Driver Side Front Mounting Location

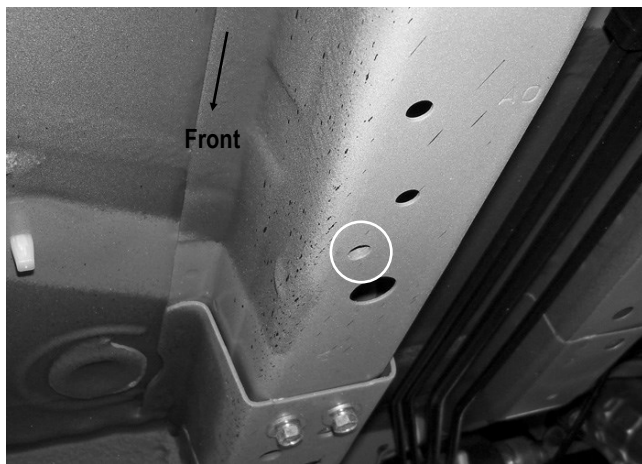

(Fig 1B) Driver Front Support Bracket Mounting Location

## STEP 2

Assemble (1) Driver Front Mounting Bracket (DFM/PFM) and (1) Driver Front Support Bracket (DFS/PFS), (Fig 2) together with the included (4) M8X1.25-20mm Hex Flange Bolts and (4) M8X1.25 Hex Flange Nuts, (Fig 2). Do not fully tighten hardware at this time.

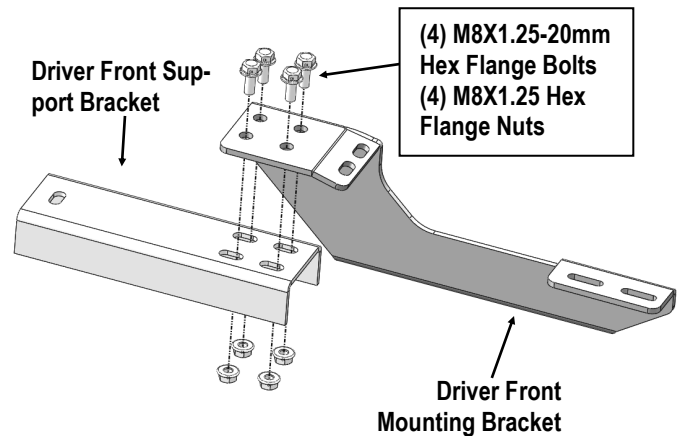

(Fig 2) Driver Side Front Brackets Assembly

## STEP 3

Position the assembled Driver Front Mounting Bracket and Driver Front Support Bracket up to the vehicle. Hang the assembled Bracket to the (2) threaded holes with (2) M8X1.25-30mm Hex Bolts, (2) M8 Lock Washers and (2) M8 Large Flat Washers, (Figs 3 & 4).

Line up the slot at the end of the Support Bracket with the threaded hole on the inner frame channel. Bolt the Support Bracket to the frame channel with (1) M8X1.25-30mm Hex Bolt, (1) M8 Lock Washer and (1) M8 Large Flat Washer, (Figs 3 & 4). Do not fully tighten hardware at this time.

# iBoard®

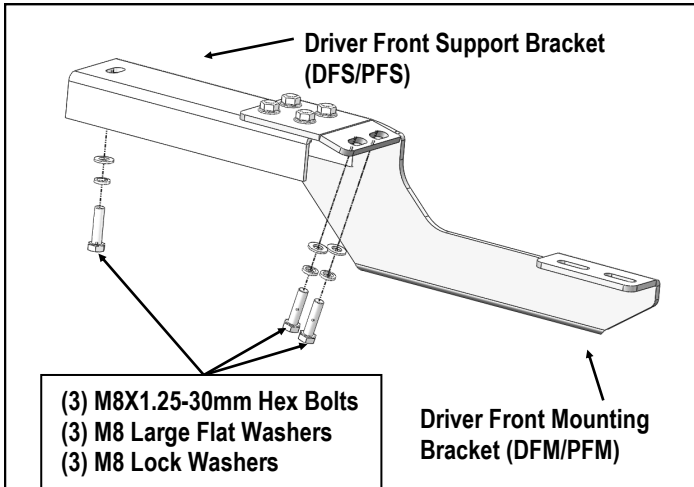

(Fig 3) Driver Side Front Brackets Installation

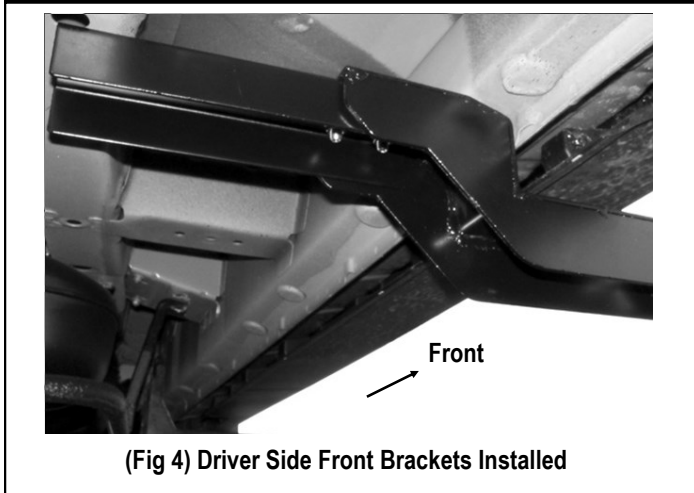

(Fig 4) Driver Side Front Brackets Installed

## STEP 4

Move to the driver side rear of the vehicle, (Fig 5). Insert the (1) (1) M10X1.5-35mm Bolt Plate into the oval hole. And thread (1) M10 Plastic Washer on the welded bolt down against the body panel, (Fig 5). Rotate the M10 Bolt Plate 90-degrees to across the oval hole in the body panel.

Repeat this Step to install the second Bolt Plate in the other factory oval hole.

**NOTE:** The Plastic Washer is designed to prevent the M10 Bolt Plate from falling into the channel within the Bracket installation.

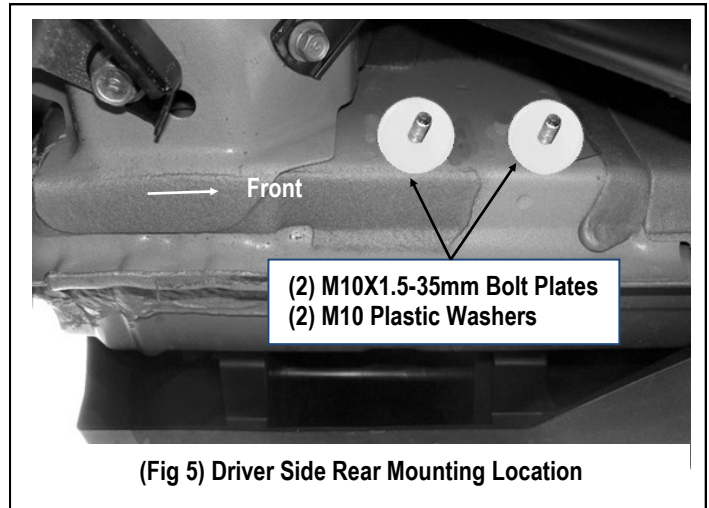

(Fig 5) Driver Side Rear Mounting Location

## STEP 5

Attach (1) Driver Rear Mounting Bracket (DRM) to the installed (2) M10 Bolt Plates with (2) M10 Flat Washers, (2) M10 Lock Washers and (2) M10 Hex Nuts, (Fig 6). Do not fully tighten hardware at this time.

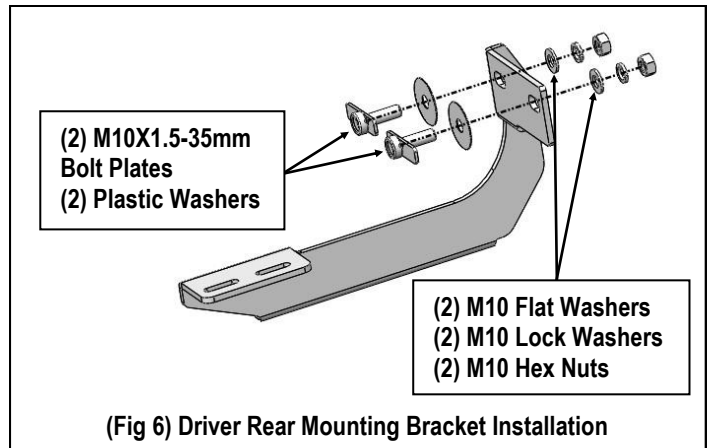

(Fig 6) Driver Rear Mounting Bracket Installation

## STEP 6

Once all (2) mounting brackets are installed, then proceed to the Step Bar installation. According to the style of Step Bar proceed to the correct installation STEPS.

**Note:** Aluminum Step Bar refer to STEP 7; Stainless Steel Step Bar skip to STEP 8.

# iBoard®

## STEP 7

### Aluminum Step Bar Installation:

Select a **Aluminum Step Bar**. Slip (2) M6x1-20mm Square Head Bolts into each bottom channel (**Fig 7**). Carefully position the Step Bar onto the (2) Mounting Brackets.

**IMPORTANT:** Do not slide the Step Bar on the Brackets or the bottom surface of the board will be damaged. Attach the Step Bar to each Mounting Brackets with (2) M6x1-20mm Square Head Bolts, (2) M6 Large Flat Washers and (2) M6x1 Nylon Lock Nuts, (**Fig 8**). Do not fully tighten at this time.

Level and adjust the Step Bar and fully tighten all hardware.

Repeat **Steps 1-7** for the other side Step Bar installation. **The installation is completed!!!**



(Fig 7) Slip M6X1-20mm Square Head Bolts Into The Bottom Channels

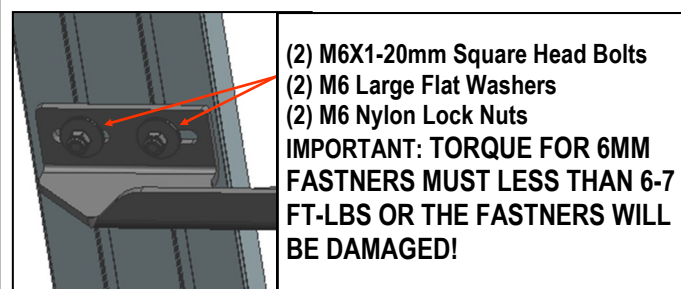

(Fig 8) Step Bar Installed Onto Mounting Bracket

## STEP 8

### Stainless Steel Step Bar Installation:

Select a **Stainless Steel Step Bar** (with the U-Sliders installed on the Bar). Loose the U-Sliders, reposition the U-Sliders onto the board according to the (2) Installed Mounting Brackets location, (**Fig 9**). Re-secure the U-Sliders on the Step Bar. Attach the Step Bar to the installed Mounting Brackets with (4) M6X1-20mm Hex Bolts, (4) M6 Large Flat Washers & (4) M6 Lock Washers, (**Fig 10**). Do not fully tighten hardware at this time.

Level and adjust the Step Bar and fully tighten all hardware.

Repeat **Steps 1-5 and 8** for the other side Step Bar installation. **The installation is completed!!!**

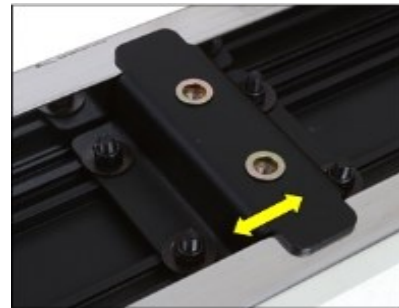

(Fig 9) Slide & line up the U-Slider with the installed mounting brackets along bottom channel

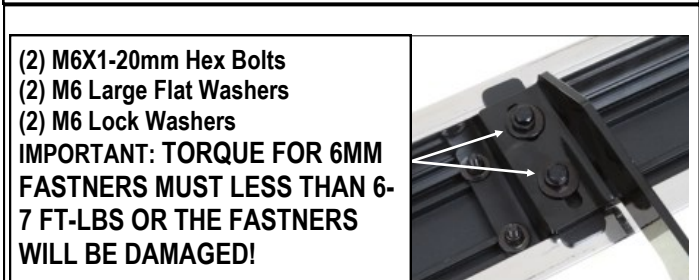

(Fig 10) Step Bar Installed on Bracket Installed

### Attention

Do periodic inspections to the installation to make sure that all hardware is secure and tight. In order to protect your bars/boards, please use mild soap/non-abrasive products for cleaning only.