

PARTS LIST:

Item	QTY	Description	Item	QTY	Description
#1	2	Running Board(use for left or right)	#13	2	M12X1.75 - 35mm Hex Bolts
#2	6	Cab Mounting Brackets	#14	4	12mm x 37mm x 3mm Flat Washers
#3	2	Front Bracket Spacers	#15	3	M12 Lock Washers
#4	1	Driver Bed Rear Mounting Bracket(DRB)	#16	3	M12 Hex Nuts
#5	1	Passenger Bed Rear Mounting Bracket(PRB)	#17	10	M10X1.5 Clip Nuts
#6	1	Driver/Left Rear Mounting Bracket(DRM)	#18	30	M10X1.5 - 30mm Hex Bolts
#7	1	Passenger Rear Mounting Bracket(PRM)	#19	48	M10 Large Flat Washers
#8	1	2011-16 Only Driver Rear Support Bracket(DRS1)	#20	30	M10 Lock Washers
#9	1	1999-2010 Driver Rear Support Bracket(DRS)	#21	18	M10 Hex Nuts
#10	1	Passenger/Right Rear Support Bracket(PRS)	#22	28	M6X1.0 - 20mm T-Bolts
#11	1	2011-16 Driver Rear M12X35 Bolt Plate	#23	28	M6 Flat Washers
#12	2	M12X35 Bolt/M10 Nut Plates	#24	28	M6 Nylon Lock Nuts

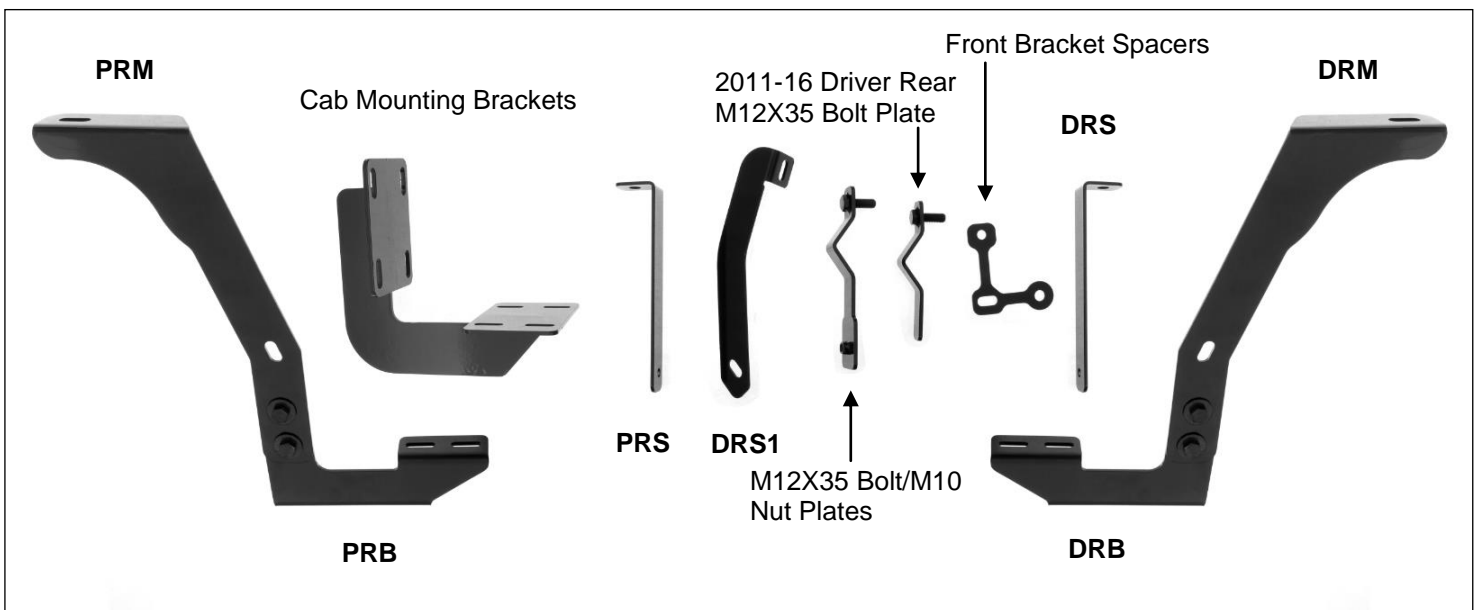

IMPORTANT ALERT: FOR WHEEL TO WHEEL APPLICATION, WEIGHT TO THE REAR END AREA OF THE RUNNING BOARD BEHIDE THE LAST BRACKET NEED TO LESS THEN 130KG.OVERWEIGHT IN THIS AREA MAYBE DAMAGE YOUR RUNNING BOARD.

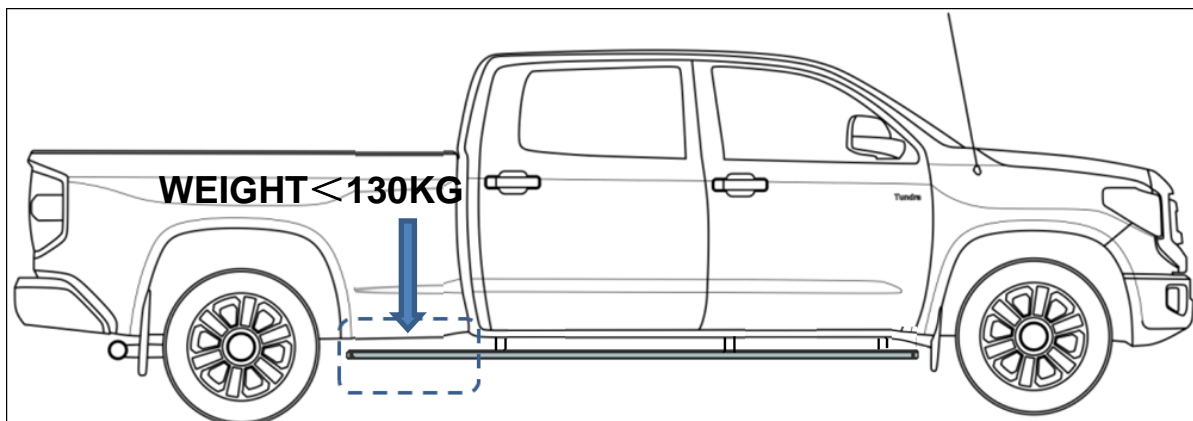

PROCEDURE:

- 1. REMOVE CONTENTS FROM BOX. VERIFY ALL PARTS ARE PRESENT. READ INSTRUCTIONS CAREFULLY BEFORE STARTING INSTALLATION. ASSISTANCE IS RECOMMENDED. DRILLING IS REQUIRED.**
- 2.** Starting on the driver side of the vehicle, locate the (4) pairs of factory holes in the pinch weld under the rocker panel, **(Figures 1A, 1B, 2 & 6)**. The mounting locations for the (3) Brackets attached to the cab will be the 1st, 3rd and 4th pairs of mounting holes, **(Figure 1A)**. An additional 4th Bracket will also attach to the channel on the bottom of the bed. **NOTE:** Mounting locations may be covered with tape or undercoating. Remove tape and/or undercoating as necessary to ensure that Brackets are attached directly to the body panels.
- 3.** Move to the driver side front mounting location, **(Figure 1B)**. Select (1) M10 Clip Nut. Insert the Clip Nut into the rectangular opening first then slide the Nut over the round hole next to the opening, **(Figure 2)**. **NOTE:** Threaded Nut must go towards the inside of the body panel.
- 4.** Next, select (1) Front Bracket Spacer and (1) Cab Mounting Bracket. Line up the (2) end holes in the Spacer with the Clip Nut and the forward hole in the pinch weld, **(Figure 3)**. Insert (1) M10 Hex Bolt, (1) M10 Lock Washer and (1) M10 Flat Washer through the top hole in the Bracket, the Spacer and into the Clip Nut, **(Figure 4)**. Leave hardware loose. Bolt the bottom of the Bracket to the pinch weld, (and Spacer), with (2) M10 Hex Bolts, (4) M10 Flat Washers, (2) M10 Lock Washers and (2) M10 Hex Nuts, **(Figure 4)**. **NOTE:** Insert Hex Bolts in through the pinch weld first and then the Bracket.
- 5.** Move to the center, (3rd), mounting location along the pinch weld. Select (2) M10 Clip Nuts. Insert the Clip Nuts into the rectangular opening and over the round holes as described in **Step 3, (Figures 5 & 6)**. Select (1) Cab Mounting Bracket. Attach the Bracket to the Clip Nuts with (2) M10 Hex Bolts, (2) M10 Lock Washers and (2) M10 Flat Washers. Attach the Bracket to the pinch weld with (2) M10 Hex Bolts, (4) M10 Flat Washers, (2) M10 Lock Washers and (2) M10 Hex Nuts, **(Figure 7)**.
- 6.** Repeat **Step 5** to attach the Cab Mounting Bracket to the last mounting location at the back of the cab.
- 7.** Select the correct procedure for installing the rear Bed Mounting Bracket assembly under the bed:
 - 1999-2010 Driver side rear bed mounting Bracket assembly:**
 - a.** Locate the square reinforcing tube welded to the bottom of the bed above and in front of the rear tire. Select (1) M12 Bolt/M10 Nut Plate, **(Figure 8A)**. Hold the Bolt/Nut Plate upside-down against the bottom of the tube with the M12 Bolt inserted into the oval hole, **(Figure 8B)**. Mark the location of the Nut onto the bottom of the tube. Drill the location with a 7/16" Drill Bit.
 - b.** Insert the Bolt/Nut Plate into the tube with the M12 Bolt out through the factory hole, **(Figures 10, 12B & 14B)**. Line up the M10 Nut with the drilled hole in the tube.
 - c.** Select the driver side Bed Mounting Bracket, **(Figure 9)**. Attach the Bracket to the M12 Bolt on the Bolt/Nut Plate with a M12 Flat Washer, M12 Lock Washer and M12 Hex Nut, **(Figures 10 & 12B)**. Leave loose at this time.
 - d.** Select the 1999-2010 driver side Rear Support Bracket, **(Figure 11)**. Bolt the Bracket to the bottom of the tube and the Bolt/Nut Plate with (1) M10 Hex Bolt, (1) M10 Lock Washer and (1) M10 Flat Washer, **(Figures 12A & 12B)**. Attach the lower end of the Support Bracket to the front side of the Mounting Bracket with (1) M10 Hex Bolt, (2) M10 Flat Washers, (1) M10 Lock Washer and (1) M10 Hex Nut, **(Figure 12B)**. Do not tighten hardware at this time.
 - 1999-2016 Passenger side rear mounting Bracket assembly:**
 - a.** Repeat the previous 1999-2010 driver side procedure **(Steps 7a—d)** for 1999-2016 passenger side rear bed bracket installation. Once completed, skip to **Step 8**.
 - 2011-2016 Driver side only rear mounting Bracket assembly:**
 - a.** Release the plastic vent tube from the factory bracket, **(Figure 13)**. Remove the plastic bracket from the square tube welded to the bottom of the bed. Insert the 2011-15 12mm Bolt Plate into the end of the tube and out the factory hole in the bottom, **(Figures 14A & 14B)**. Reinstall the plastic bracket and vent tube, **(Figure 15)**.
 - b.** Select the driver side Bed Mounting Bracket. Attach the Bracket to the M12 Bolt on the Bolt Plate with (1) M12 Flat Washer, (1) M12 Lock Washer and (1) M12 Hex Nut, **(Figures 16 & 17B)**. Leave hardware loose at this time.

- c. Select the driver side 2011-2016 Rear Support Bracket, **(Figure 17A)**. Attach the 90-deg bent end of the Support Bracket to the hole in the top of the leaf spring bracket with (1) M12 x 35mm Hex Bolt, (2) M12 Flat Washers, (1) M12 Lock Washer and (1) M12 Hex Nut, **(Figure 17B & 17C)**. Bolt the flat end of the Bracket to the front of the Bed Bracket with (1) M10 Hex Bolt, (2) M10 Flat Washers, (1) M10 Lock Washer and (1) M10 Hex Nut, **(Figure 17B)**. Leave hardware loose at this time.
8. Once the upper Bed Mounting Bracket assembly has been completely installed, select the driver side rear Mounting Bracket, **(Figures 12A, 12B & 17B)**. Bolt the Bracket to the back of the upper Bracket assembly with (2) M10 Hex Bolts, (4) M10 Flat Washers, (2) M10 Lock Washers and (2) M10 Hex Nuts, **(Figures 12A, 12B & 17B)**. Snug but do not tighten hardware.
9. Once all Brackets have been installed, Select a Running Board. Slip (14) M6 T-Bolts into each bottom channel **(Figure 18A)**. Carefully position the Running Board onto the Mounting Brackets. Attach the Running Board to the Cab Mounting Brackets with (4) M6 T-bolts, (4) M6 flat washers and (4) M6 nylon lock nuts, to Rear bracket with (2) M6 T-bolts, (2) M6 flat washers and (2) M6 nylon lock nuts **(Figure 18B & 18C)**. Do not tighten hardware at this time
10. Level and adjust Running Board properly and tighten all hardware. **NOTE: Torque all M6 nylon lock nuts to 7 lb-ft.**
11. Repeat **Steps 2—10** for passenger Running Board installation, (See **Step 7** for passenger side bed Mounting Bracket specific information).
12. Periodically check and retighten the hardware as necessary.

To protect your investment, wax this product after installing. Regular waxing is recommended to add a protective layer over the finish. Do not use any type of polish or wax that may contain abrasives that could damage the finish.

For Polished Finishes: Aluminum polish may be used to polish small scratches and scuffs on the finish. Mild soap may be used also to clean the Running Board.

For black finishes: Mild soap may be used to clean the Running Board.

Driver Side Installation Pictured

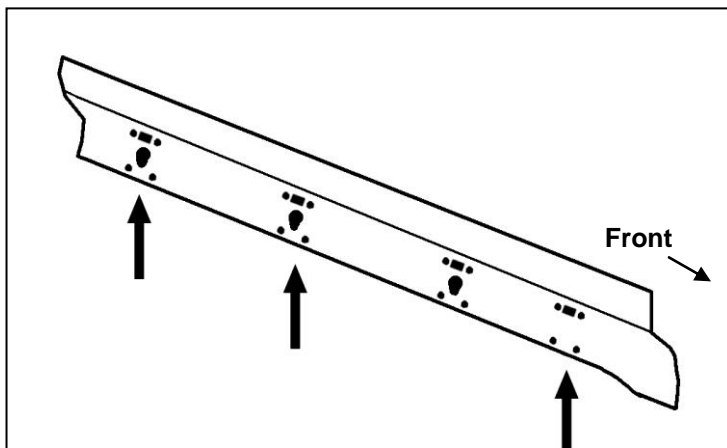

(Fig 1A) Driver side mounting locations on cab

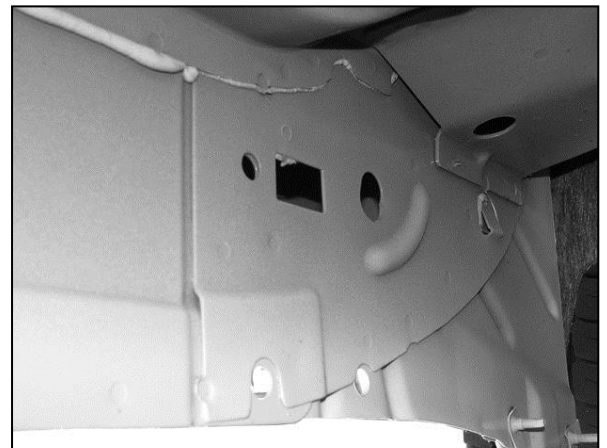

(Fig 1B) Driver side front mounting location

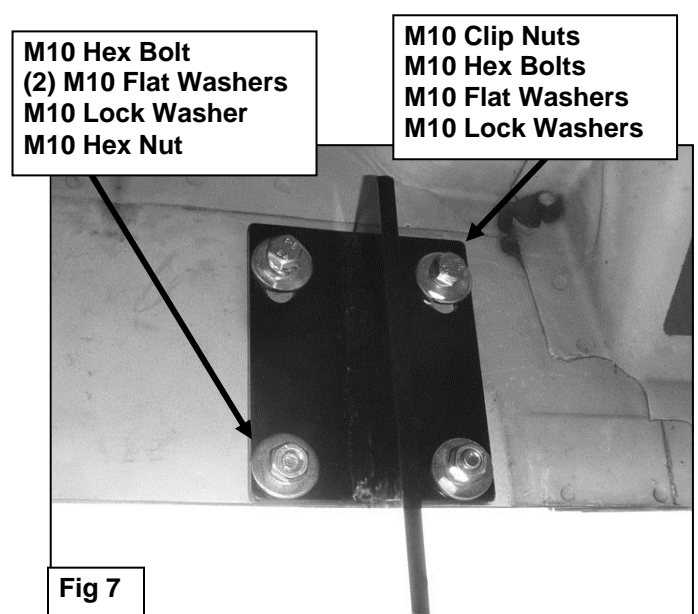
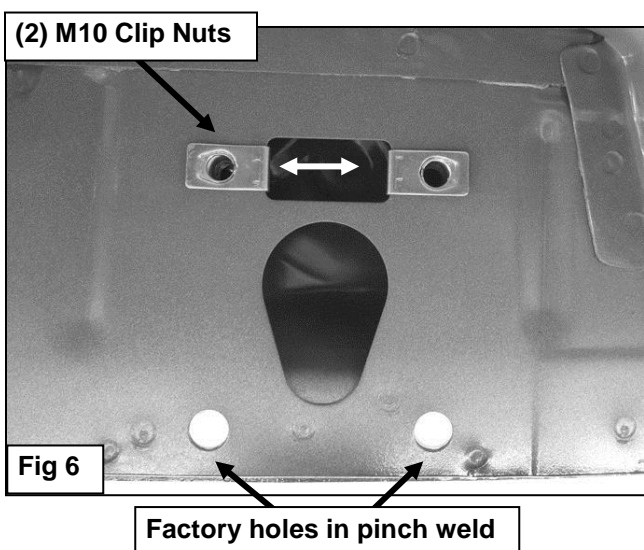
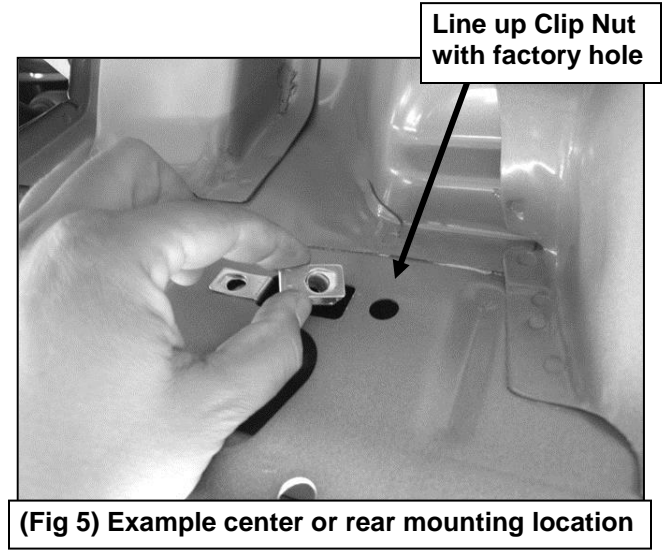
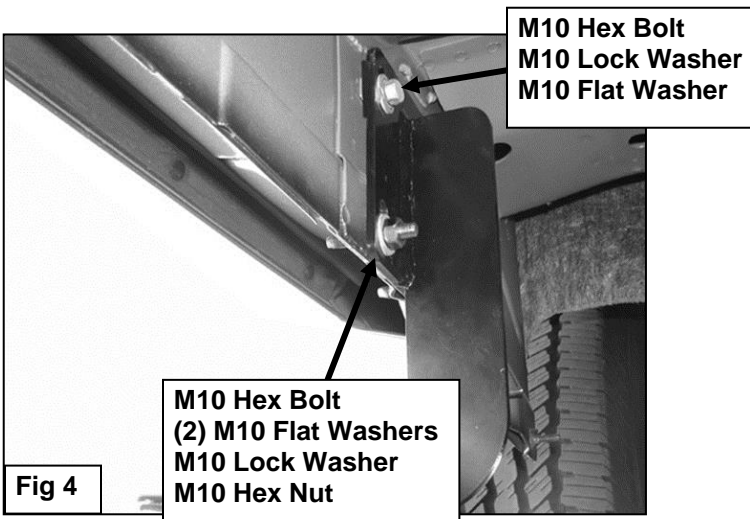
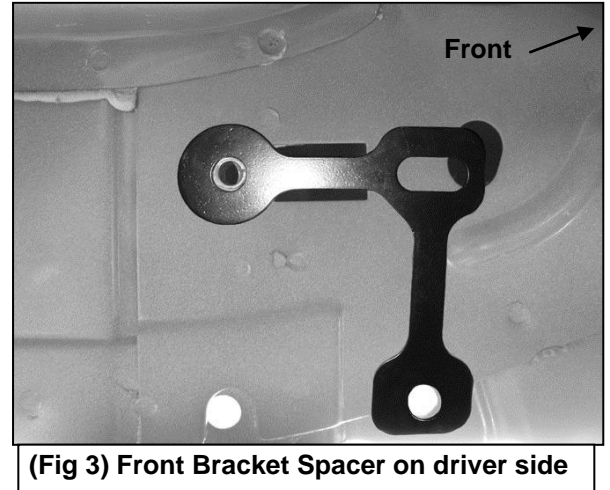
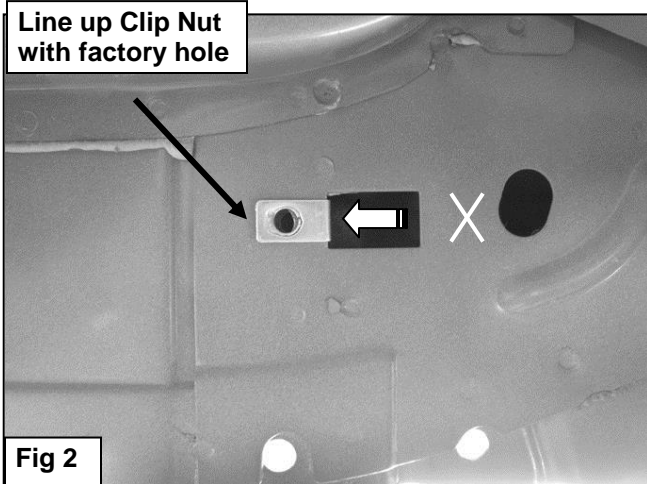

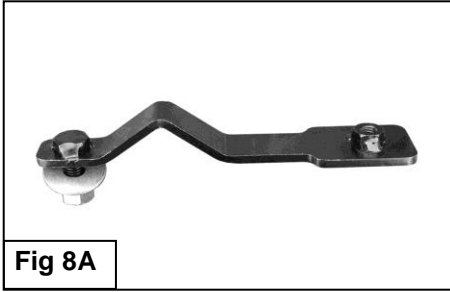

IMPORTANT: the Bolt Plate installation pictured in Figures 8—12 applies only to:
1999-2010 Driver side bed and support bracket
1999-2016 Passenger side bed and support bracket

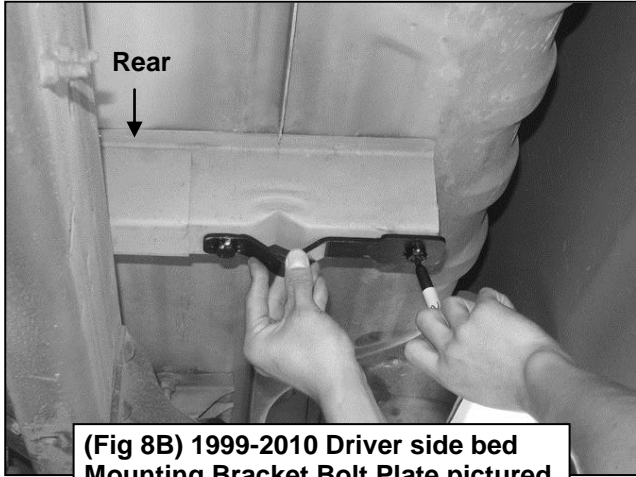

(Fig 8B) 1999-2010 Driver side bed Mounting Bracket Bolt Plate pictured

(Fig 9) Driver side bed Mounting Bracket

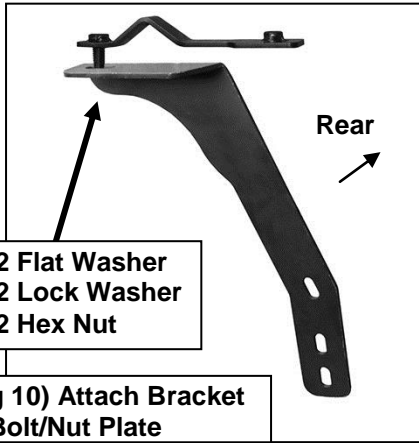

(Fig 10) Attach Bracket to Bolt/Nut Plate

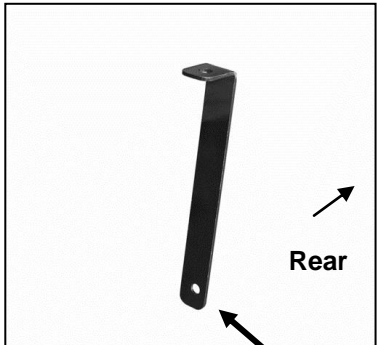

(Fig 11) 1999-2010 Driver side Support Bracket pictured. Note slightly offset hole on bottom of bracket

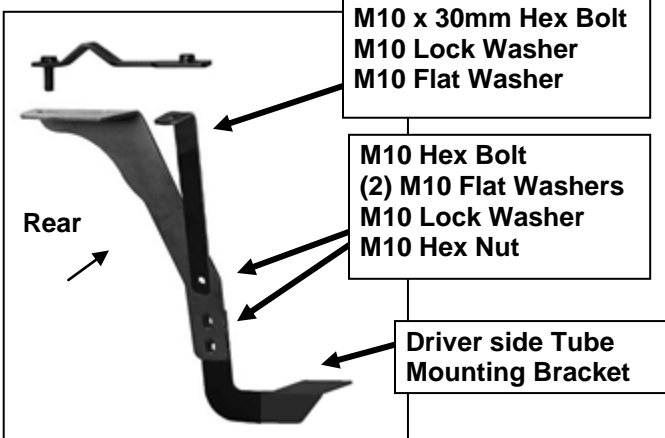

(Fig 12A) Attach Support Bracket to Bolt/Nut Plate



(Fig 12B) 1999-2010 Complete driver side bed Mounting Bracket assembly pictured

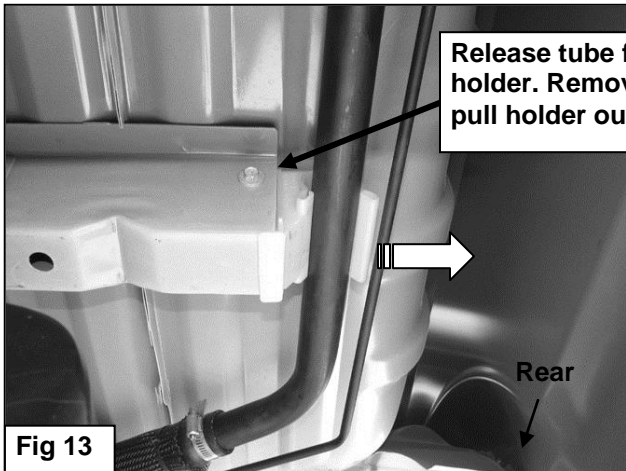

(Fig 14A) 2011-16 Driver side bed Mounting Bracket Bolt Plate only

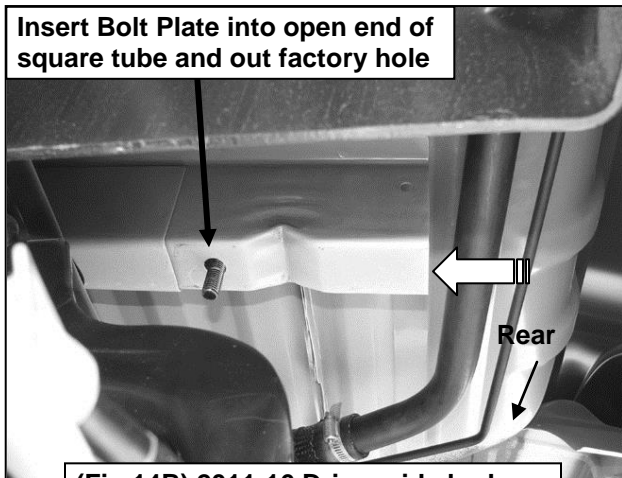

(Fig 14B) 2011-16 Driver side bed Mounting Bracket Bolt Plate pictured

IMPORTANT: Figures 13—18 apply to 2011-16 Driver side bed Mounting Bracket only

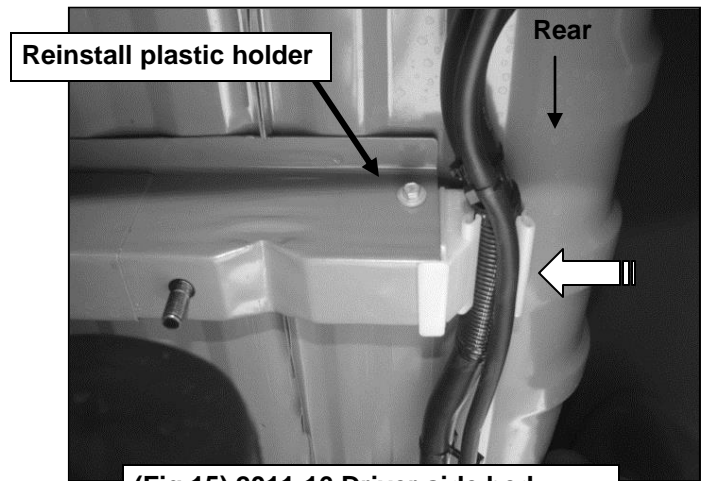

(Fig 15) 2011-16 Driver side bed Mounting Bracket Bolt Plate pictured



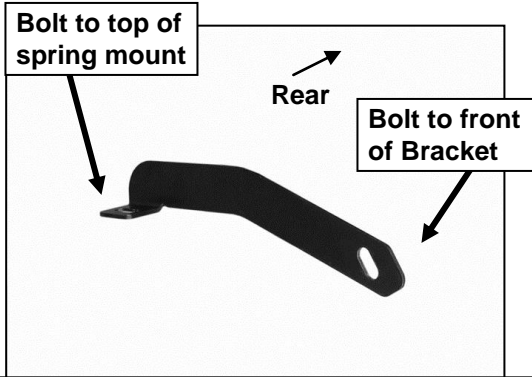

(Fig 17A) 2011-16 driver side rear Support Bracket for Bed Mounting Bracket

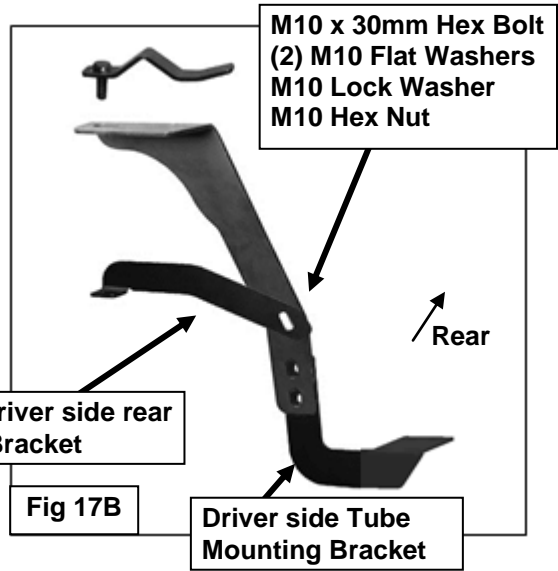

2011-16 driver side rear Support Bracket

Fig 17B

Driver side Tube Mounting Bracket

- M12 x 35mm Hex Bolt
- (2) M12 Flat Washers
- M12 Lock Washer
- M12 Hex Nut

2011-16 driver side rear Support Bracket

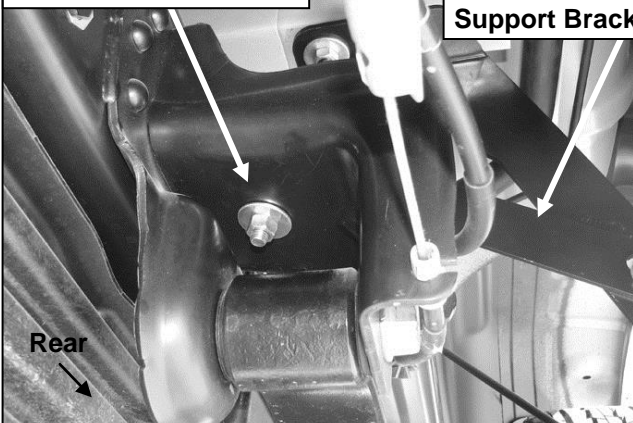

(Fig 17C) Bolt the 2011-16 driver side rear Support Bracket to the top of the rear spring mount



(Fig 18A) Slip 6mm T-bolts into the bottom

- (4) M6X1 - 20mm T- Bolts
- (4) M6 Flat Washers
- (4) M6 Nylon Lock Washers

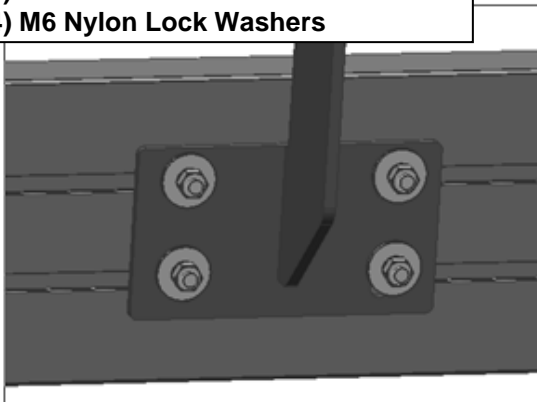

(Fig 18B) Cab Mounting Bracket

- (2) M6X1 - 20mm T- Bolts
- (2) M6 Flat Washers
- (2) M6 Nylon Lock Washers

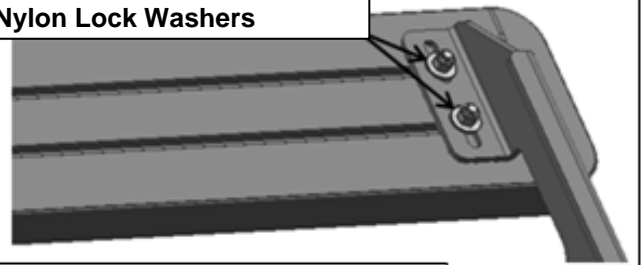

(Fig 18C) Rear Bracket Installation