

**PARTS LIST:**

Item	Qty	Description	Item	Qty	Description
#1	2	Running Board(use for left or right)	#10	4	10mm Lock Washers
#2	6	Front/Center Mounting Brackets	#11	4	10mm x 30mm x 2.5mm Flat Washers
#3	1	Driver/left Rear Mounting Bracket	#12	4	10mm Hex Nuts
#4	1	Passenger/right Rear Mounting Bracket	#13	8	10mm Plastic Washers
#5	18	8mm x 24mm x 2mm Washers	#14	28	6mm Nylon Lock Nuts
#6	18	8mm Plastic Washers	#15	28	6-1.0mm x 20mm T-Bolts
#7	18	8mm Nylon Lock Nuts	#16	28	6mm x 22mm x 2mm Flat Washers
#8	2	10mm x 40mm T-Bolt Plates			
#9	2	10mm x 35mm Bolt Plates			

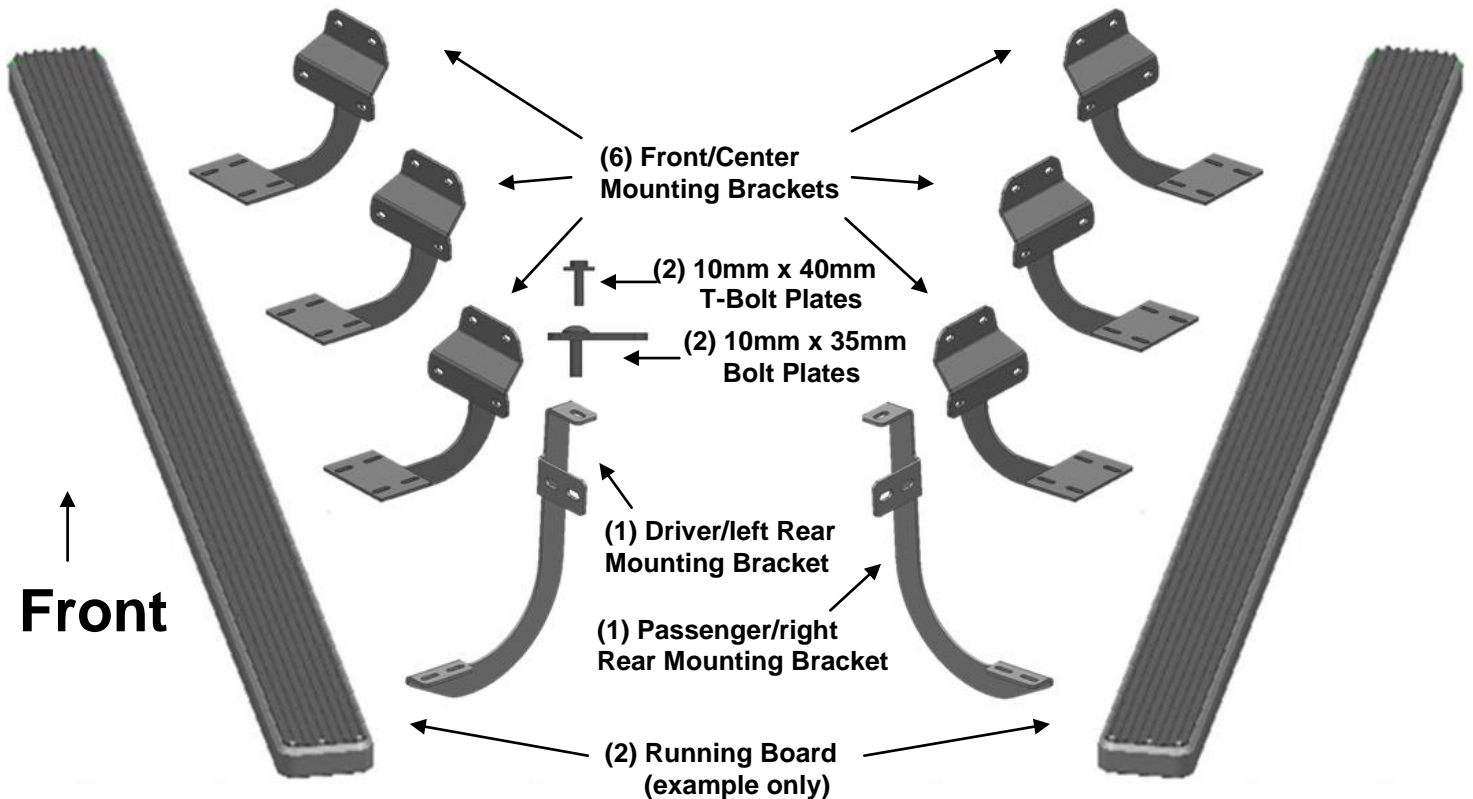

**IMPORTANT ALERT: FOR WHEEL TO WHEEL APPLICATION, WEIGHT TO THE REAR END AREA OF THE RUNNING BOARD BEHIDE THE LAST BRACKET NEED TO LESS THEN 130KG.OVERWEIGHT IN THIS AREA MAYBE DAMAGE YOUR RUNNING BOARD.**

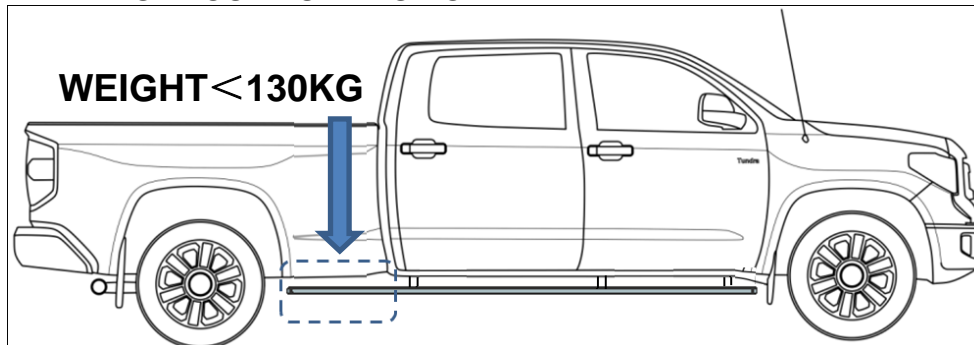

**PROCEDURE:**

**REMOVE CONTENTS FROM BOX. VERIFY ALL PARTS ARE PRESENT. READ FACTORY BODY BOLT REMOVAL INSTRUCTIONS AND INSTALLATION INSTRUCTIONS CAREFULLY BEFORE STARTING INSTALLATION. REMOVE FACTORY OR AFTERMARKET RUNNING BOARDS.**

1. Start the installation under the driver side of the vehicle. Locate the front factory running board mounting location along the inner side of the body, **(Figure 1)**.
2. Slide (1) Plastic Washer over each factory mounting stud in the body panel, **(Figures 2 & 3)**.  
**IMPORTANT:** The Plastic Washers are designed to prevent corrosion between the aluminum body panel and the steel mounting brackets. **Do not install the Brackets without the Plastic Washers.**
3. Select (1) Mounting Bracket. **NOTE:** The (3) Brackets that attach to the (3) factory mounting locations are universal and will fit left or right side. Attach the Mounting Bracket to the (3) factory studs with (3) 8mm Flat Washers and (3) 8mm Nylon Lock Nuts, **(Figures 4 & 5)**. Leave hardware loose at this time.
4. Repeat **Steps 1-3** to install the (2) center driver side Bracket, **(Figure 6)**.
5. Move to the rear body mount at the back of the cab. Locate the oval hole in the body mount support directly above the square hole in the side of the body panel, **(Figure 7)**. Thread (1) 10mm Plastic Washer onto (1) 10mm x 40mm T-Bolt, **(Figure 8)**. Thread the Plastic Washer all the way down the threaded end of the T-Bolt. By hand, (pliers can also be used), bend the sides of the Plastic Washer up around the sides of the Bolt Plate, **(Figure 9)**.
6. Insert the Bolt Plate and Washer into the oval hole. Once the Bolt Plate is in the hole, thread a second Plastic Washer down until it is tight against the body panel, **(Figure 10)**. If necessary, use scissors to trim plastic washer for easier installation. **IMPORTANT:** Do not install the rear Bolt Plates and Brackets without the Plastic Washers.
7. Next, locate the square hole in the side of the body panel, **(Figure 7)**. Select the 10mm x 35mm Bolt Plate and (1) 10mm Plastic Washer, **(Figure 11)**. Repeat **Steps 5 & 6** to insert the Bolt Plate and Plastic Washer into the square hole. Trim Plastic Washer as required, **(Figure 12)**. Once the Bolt Plate is in the hole, thread a second Plastic Washer down until it is tight against the body panel, **(Figure 13)**.
8. Select the driver side rear Bracket. Slide the Bracket over the (2) Bolt Plates. Attach the Bracket to the Bolt Plates with (2) 10mm Flat Washers, (2) 10mm Lock Washers and (2) 10mm Hex Nuts, **(Figure 14)**. Leave hardware loose at this time.
9. Select a Running Board. Slip (14) 6mm T-bolts into each bottom channel **(Figure 15)**. Carefully position the Running Board onto the (4) Mounting Brackets. **IMPORTANT:** Do not slide, (front to back), the Running Board on the Brackets or damage to the finish may result. Attach the Running Board to the Mounting Brackets with (14) 6mm T-bolts, (14) 6mm flat washers and (14) 6mm lock nuts **(Figures 16 & 17)**. Do not tighten at this time.
10. Level and adjust the Running Board and tighten all hardware.
11. Repeat **Steps 1-10** for passenger Running Board installation.
12. Do periodic inspections to the installation to make sure that all hardware is secure and tight.

**To protect your investment**, wax this product after installing. Regular waxing is recommended to add a protective layer over the finish. Do not use any type of polish or wax that may contain abrasives that could damage the finish.

**For Polished Finishes:** Aluminum polish may be used to polish small scratches and scuffs on the finish. Mild soap may be used also to clean the Running Board.

**For Black Finishes:** Mild soap may be used to clean the Running Board.

Driver/left Installation Pictured

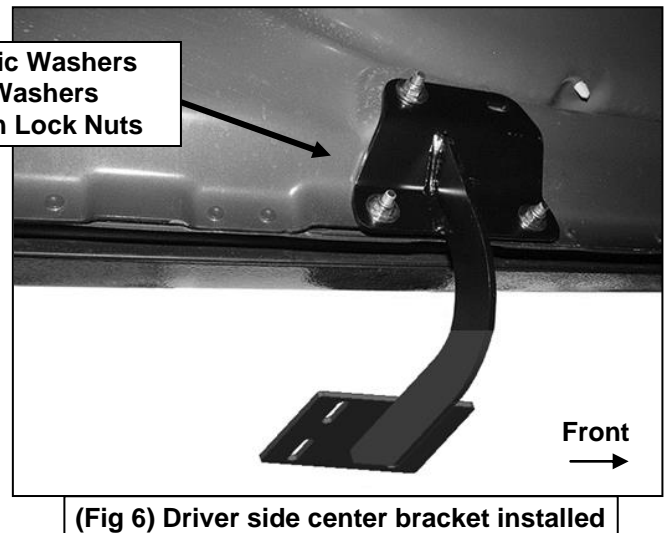
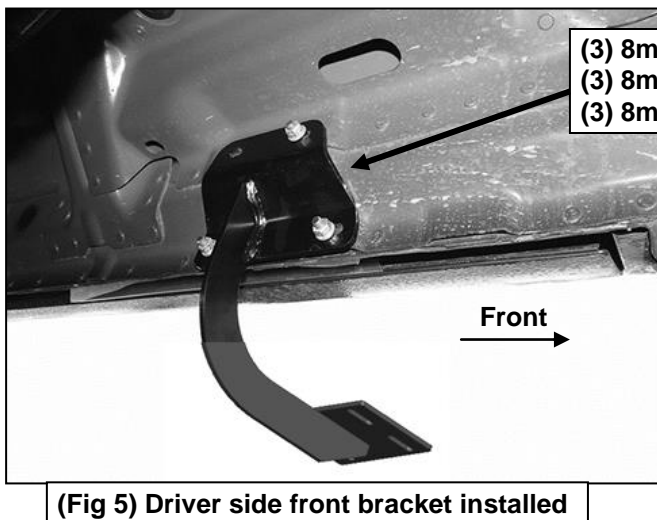
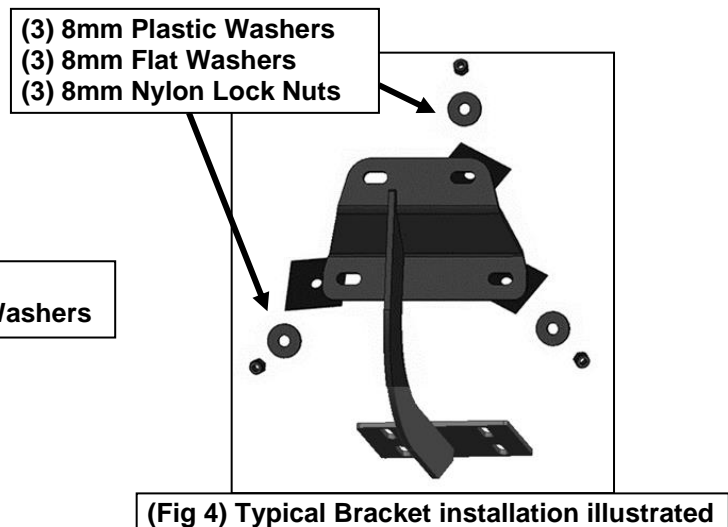
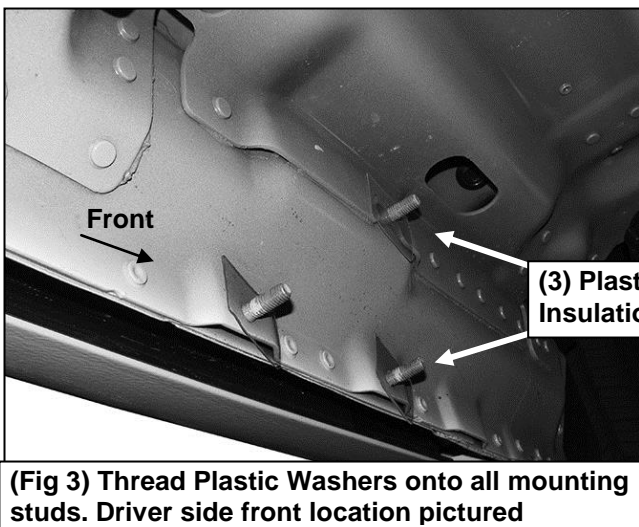
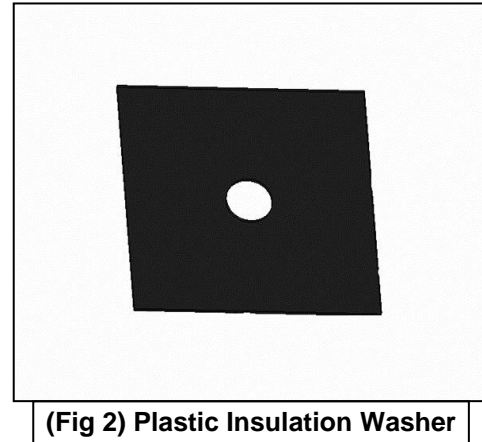
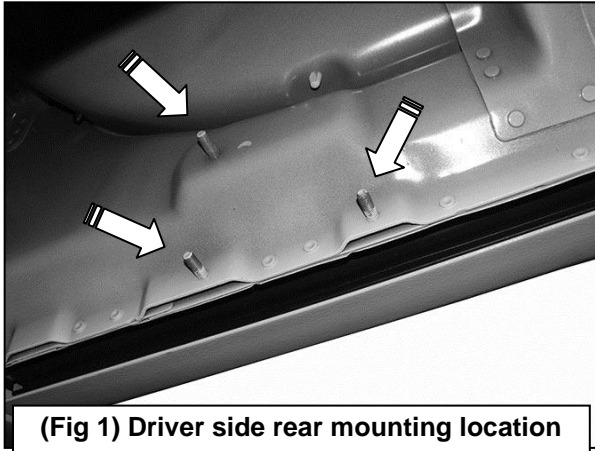

**Driver/left Installation Pictured**

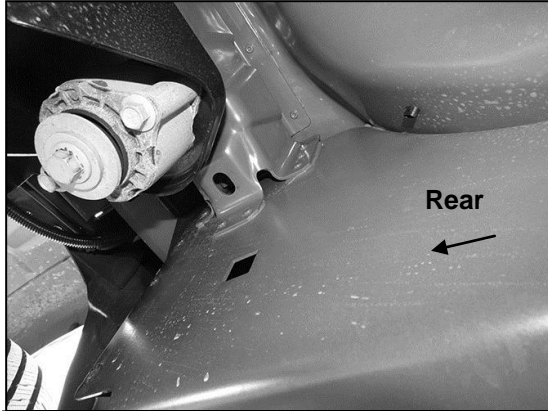

**(Fig 7) Driver side rear mounting location**



**(Fig 8) 10mm T-Bolt with Plastic Washer**

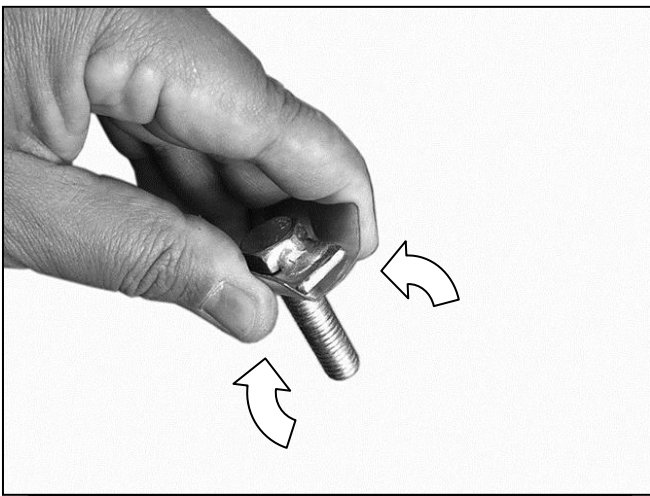

**(Fig 9) By hand, bend sides of Plastic Washer up around T-Bolt (pliers may also be used)**



**(Fig 10) Insert T-Bolt and folded Washer into oval hole. Thread second Plastic Washer onto T-Bolt**



**(Fig 11) 10mm Bolt Plate with Plastic Washer**

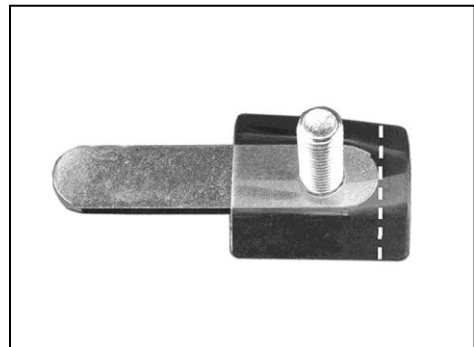

**(Fig 12) Bend sides of Plastic Washer up around Bolt Plate. If necessary, use scissors to cut off overhanging plastic. Cut washer on Bolt Plate installation only**

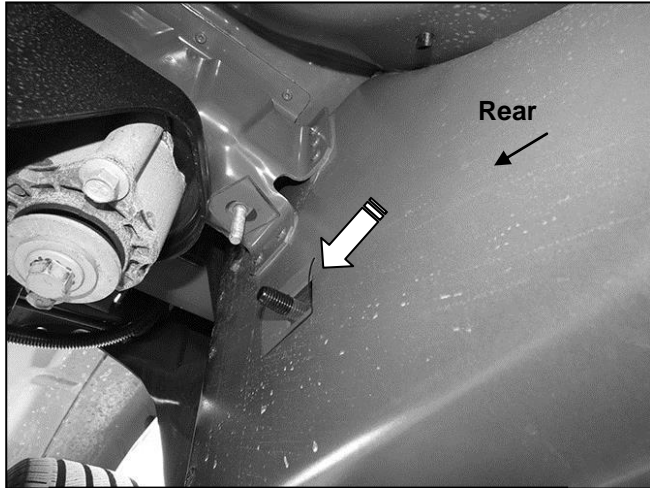

(Fig 13) Insert Bolt Plate and Washer into lower square hole. Thread second Plastic Washer onto Bolt Plate

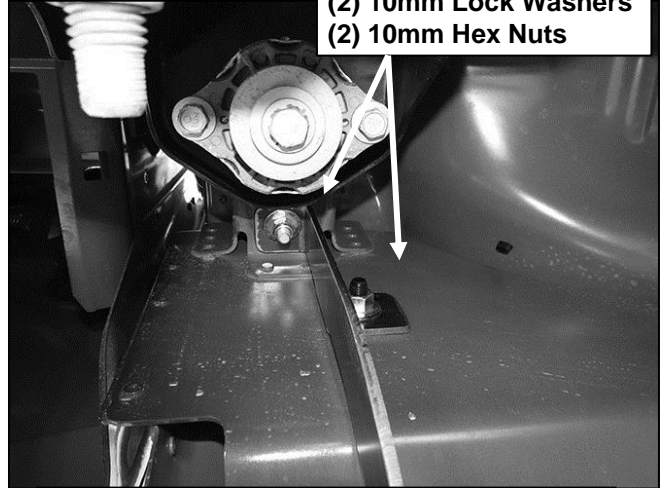

(Fig 14) Driver side rear Bracket installation



(Fig 15) Slip 6mm T-bolts into the bottom channel

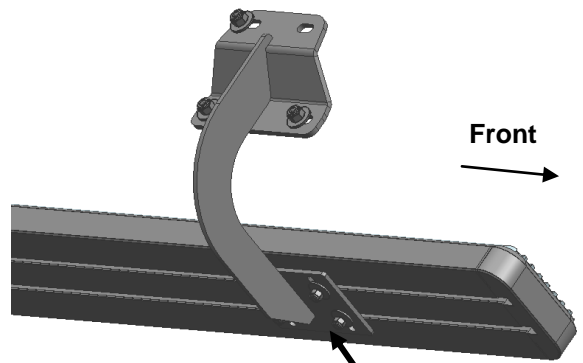

(Fig 16) (4) 6mm T-bolts  
(4) 6mm Flat Washers  
(4) 6mm Nylon Lock Nuts

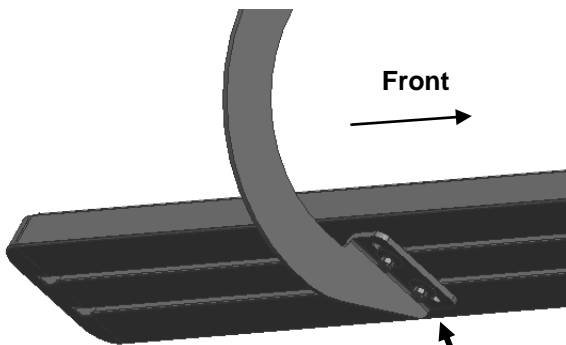

(Fig 17)

(2) 6mm T-bolts  
(2) 6mm Flat Washers  
(2) 6mm Nylon Lock Nuts