

# iBoard®

## iBoard® by APS

PART#: IB-R010

READ INSTRUCTIONS CAREFULLY BEFORE STARTING INSTALLATION. REMOVE CONTENTS FROM BOX AND VERIFY ALL PARTS ARE PRESENT. ASSISTANCE IS RECOMMENDED.

\*ROCKER PANEL MOUNT  
\*NO DRILLING REQUIRED

Fastener Size	Tightening Torque (ft-lbs)	Required
6mm	6-7	√
8mm	16-18	√
10mm	31-32	X
12mm	56-58	X
14mm	92-94	X

Item	QTY	Description	Item	QTY	Description
1#	4	Mounting Brackets	5#	4	M8 Clip Nuts
2#	12	M8X1.25-25mm Hex Bolts	6#	8	M6X1-20mm Square Head Bolts
3#	12	M8 Large Flat Washers	7#	8	M6 Large Flat Washers
4#	4	M8 Nylon Lock Nuts	8#	8	M6 Nylon Lock Nuts

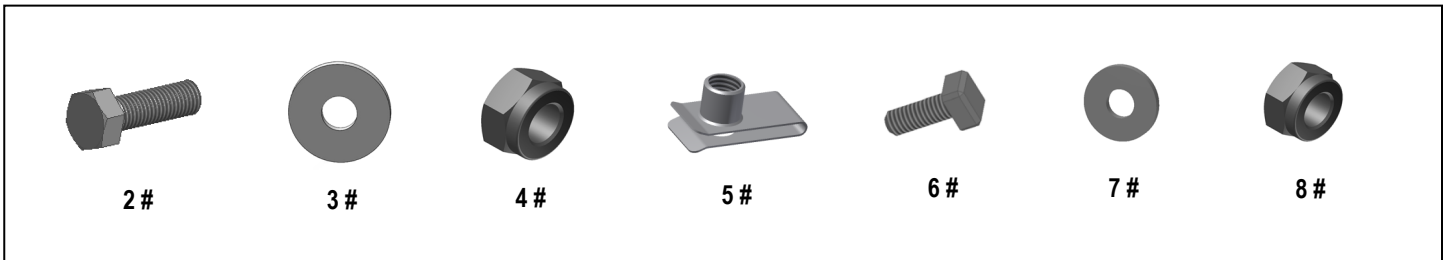

# iBoard®

Driver

Front



Passenger

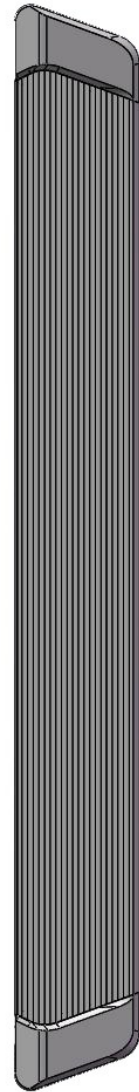
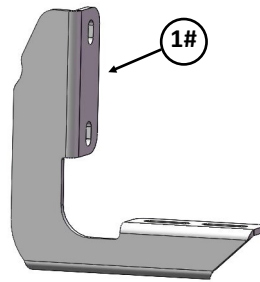
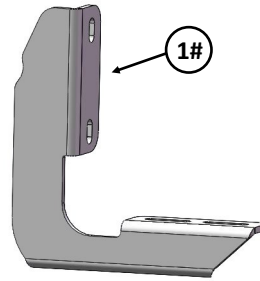
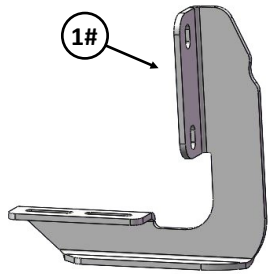
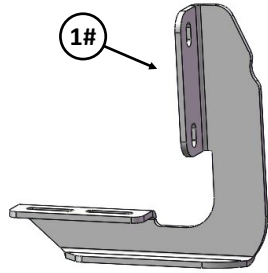

# iBoard®

## STEP 1

Starting from the passenger front side of the vehicle, locate the passenger side mounting locations, (Fig 1 & 2).

**NOTE:** The mounting holes may be covered by sealing tapes or insulation, remove as required.

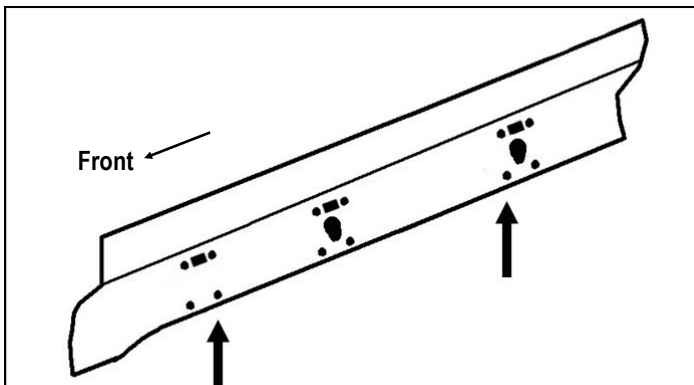

(Fig 1) Passenger Side Front Mounting Location

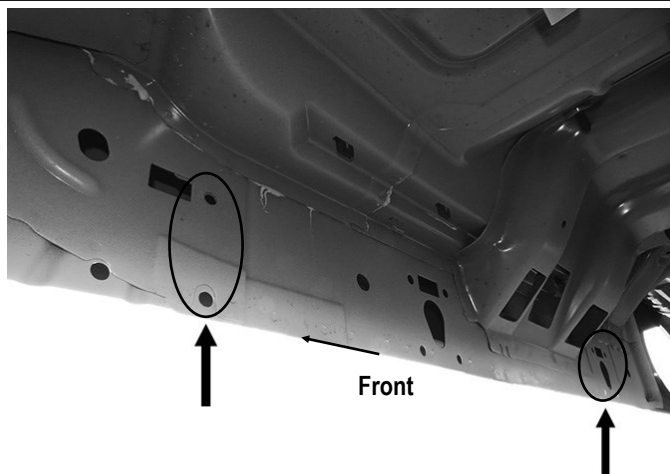

(Fig 2) Passenger Side Front Mounting Location

## STEP 2

Insert (1) M8 Clip Nut into the rectangular opening with the nut towards the inside. Line up the threaded nut on the clip with the round hole toward the rear, (Fig 3).

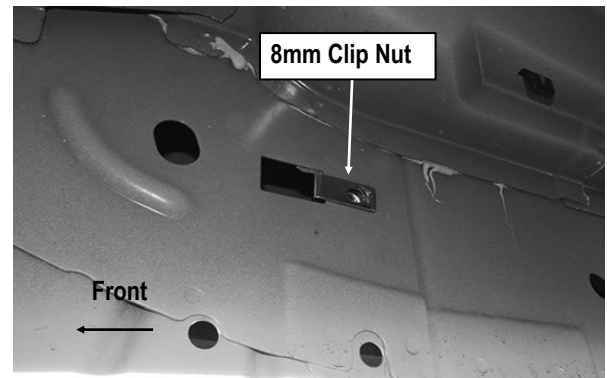

(Fig 3) M8 Clip Nut Installed  
(On Passenger Front Mounting Location)

## STEP 3

Attach the Passenger Front Mounting Bracket onto the installed M8 Clip Nut with (1) M8 Clip Nut, (1) M8X1.25-25mm Hex Bolt, and (1) M8 Large Flat Washer, (Fig 4).

Next, secure the lower mounting hole on the bracket to the pinch weld with (1) M8X1.25-25mm Hex Bolt, (2) M8 Large Flat Washers and (1) M8 Nylon Lock Nut, (Fig 4).

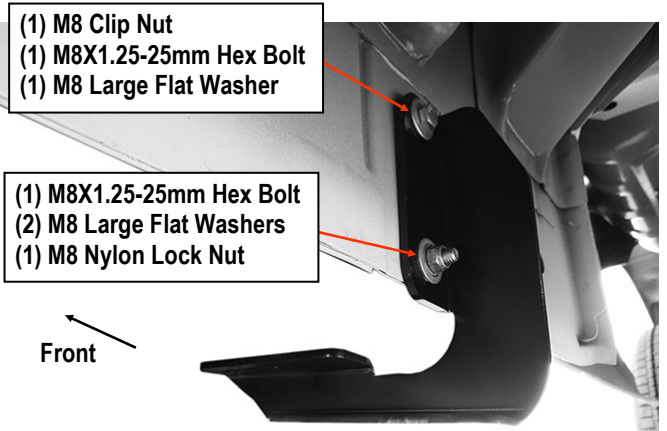

(Fig 4) Passenger Front Mounting Bracket Installed

# iBoard®

## STEP 4

Move to the Passenger Side Rear Mounting Location. Repeat **Steps 2-3** to attach the Mounting Bracket to the vehicle. Do not fully tighten hardware at this time.

## STEP 5

Select a Running Board. Slip (2) M6x1-20mm Square Head Bolts into each bottom channel (**Fig 5**). Carefully position the Running Board onto the (2) Mounting Brackets.

**IMPORTANT:** Do not slide the Running Board on the Brackets or the bottom surface of the board will be damaged. Attach the Running Board to each Mounting Bracket with (2) M6x1-20mm Square Head Bolts, (2) M6 Large Flat Washers and (2) M6 Nylon Lock Nuts (**Fig 6**). Do not fully tighten at this time.

M6X1-20mm Square Head Bolts

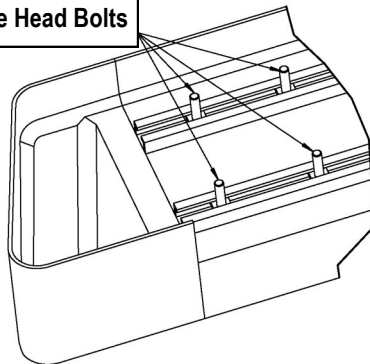

(Fig 5) Slip M6X1-20mm Square Head Bolts Into The Bottom Channels

(2) M6X1-20mm Square Head Bolts  
(2) M6 Large Flat Washers  
(2) M6 Nylon Lock Nuts

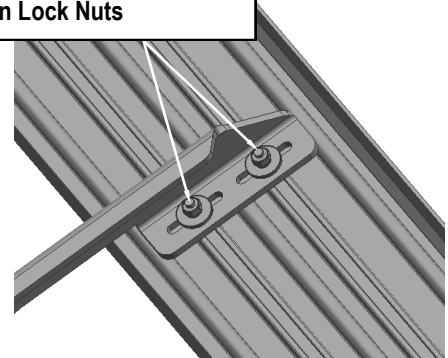

(Fig 6) Running Board Installed Onto Mounting Bracket

## STEP 6

Level and adjust the Running Board and fully tighten all hardware.

**Important:** Please follow the recommended Tightening Torques shown in the table on page 1. Don't over tighten, or the nuts/bolts will be damaged.

## STEP 7

Repeat **Steps 1-6** for the other side Running Board installation. The installation is completed .

### Attention

Do periodic inspections to the installation to make sure that all hardware is secure and tight.

In order to protect your bars/boards, please use only mild soap/non-abrasive products for cleaning.