

# iBoard®



Scan for  
Installation Video

## iBoard® by APS

PART#: IB-R175

READ INSTRUCTIONS CAREFULLY BEFORE STARTING INSTALLATION. REMOVE CONTENTS FROM BOX AND VERIFY ALL PARTS ARE PRESENT. ASSISTANCE IS RECOMMENDED.

\*ROCKER PANEL MOUNT  
\*NO DRILLING REQUIRED

Fastener Size	Tightening Torque (ft-lbs)	Required
6mm	6-7	√
8mm	16-18	√
10mm	31-32	X
12mm	56-58	X
14mm	92-94	X

Driver

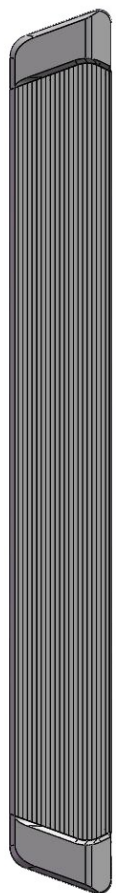

Front



Passenger

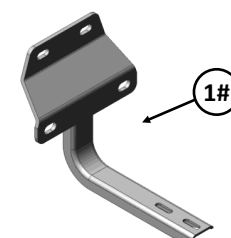
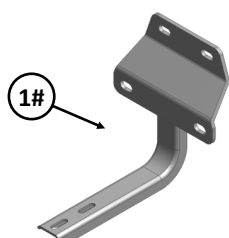
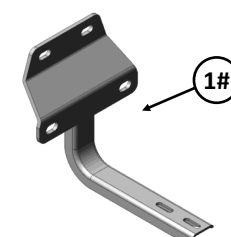
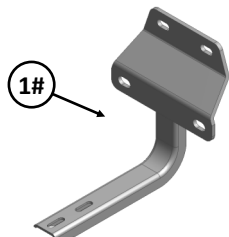
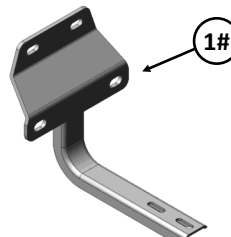
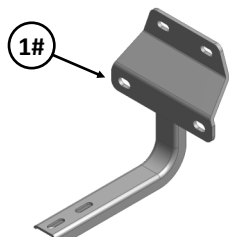



Scan for  
Installation Video

## Hardware Package A (For Bracket Installation)

Item	QTY	Description	Item	QTY	Description
1#	6	Mounting Brackets	3#	18	M8 Large Flat Washers
2#	18	M8 Plastic Washers	4#	18	M8X1.25 Nylon Lock Nuts

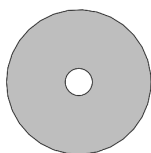

2#



3#

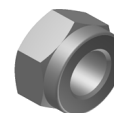

4#

## Hardware Package B (For Step Bar Installation)

Item	QTY	Description	Item	QTY	Description
1#	12	M6X1-20mm Square Head Bolts	3#	12	M6 Nylon Lock Nuts
2#	12	M6 Large Flat Washers			

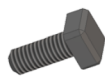

1#



2#



3#



## STEP 1

Start the installation under the passenger side of the vehicle. Locate the front factory running board mounting location along the inner side of the body, (Fig 1).

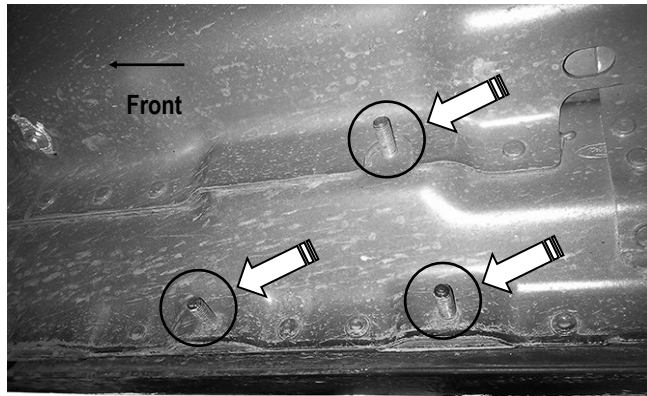

(Fig 1) Passenger Side Front Mounting Location

## STEP 2

Slide (1) M8 Plastic Washer over each factory mounting stud in the body panel, (Fig 2). **IMPORTANT:** The M8 Plastic Washers are designed to prevent corrosion between the aluminum body panel and the steel mounting brackets. **Do not install the Brackets without the Plastic Washers.**

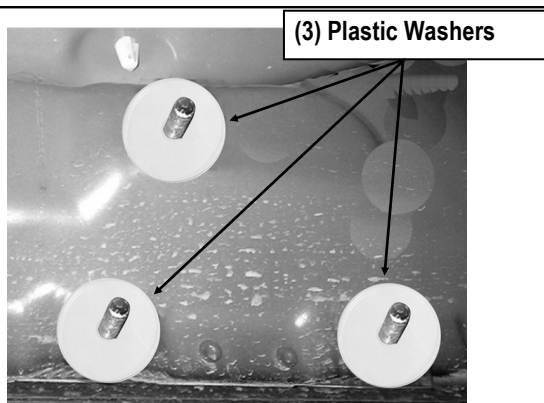

(Fig 2) Thread M8 Plastic Washers Onto All Mounting Studs (Passenger Side Rear Mounting Location Pictured)

## STEP 3

Select (1) Mounting Bracket. **NOTE: All (6) Mounting Brackets are universal and will fit driver or passenger side.** Attach the Mounting Bracket to the (3) factory studs on Passenger Side Front Mounting Location with (3) M8 Large Flat Washers and (3) M8X1.25 Nylon Lock Nuts, (Fig 3). Do not fully tighten the hardware at this time.

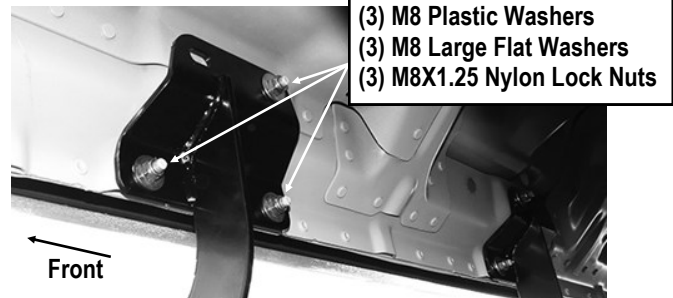

(Fig 3) Passenger Front Mounting Bracket Installed

## STEP 4

Move to the passenger side center & rear mounting locations of the vehicle. Repeat **Steps 1-3** to install the passenger side Center & Rear Mounting Brackets.

**NOTE:** All (6) Mounting Brackets will fit left or right side.

## STEP 5

Once all (3) mounting brackets are installed. Select a Running Board. Slip (3) M6X1-20mm Square Head Bolts into each bottom channel (Fig 4). Carefully position the Running Board onto the (3) Mounting Brackets. Attach the Running Board to each Mounting Brackets with (2) M6X1-20mm Square Head Bolts, (2) M6 Large Flat Washers and (2) M6 X1 Nylon Lock Nuts (Fig 5). Do not fully tighten at this time.

**IMPORTANT:** Do not slide the Running Board on the Brackets or the bottom surface of the board will be damaged.



M6X1-20mm Square Head Bolts

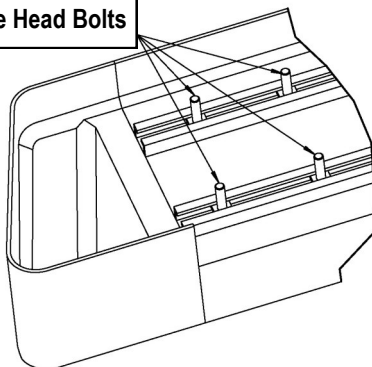

(Fig 4) Slip M6X1-20mm Square Head Bolts Into The Bottom Channels

(2) M6X1-20mm Square Head Bolts  
(2) M6 Large Flat Washers  
(2) M6X1 Nylon Lock Nuts

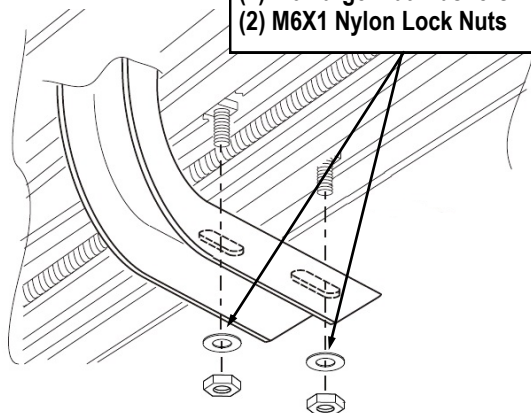

(Fig 5) Running Board Installed Onto Mounting Bracket

## STEP 6

Level and adjust the Running Board and fully tighten all hardware.

## STEP 7

Repeat **Steps 2-6** for the other side Running Board installation. The installation is completed .

### Attention

Do periodic inspections to the installation to make sure that all hardware is secure and tight.

In order to protect your bars/boards, please use mild soap/non-abrasive products for cleaning only.