

iBoard®

iBoard® by APS

PART#: IB-044

READ INSTRUCTIONS CAREFULLY BEFORE STARTING INSTALLATION. REMOVE CONTENTS FROM BOX AND VERIFY ALL PARTS ARE PRESENT. ASSISTANCE IS RECOMMENDED.

*ROCKER PANEL MOUNT
*NO DRILLING REQUIRED

Fastener Size	Tightening Torque (ft-lbs)	Required
6mm	6-7	√
8mm	16-18	√
10mm	31-32	X
12mm	56-58	X
14mm	92-94	X

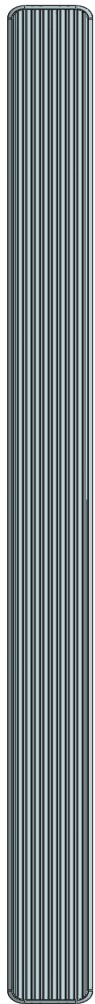

Driver Side Step Bar

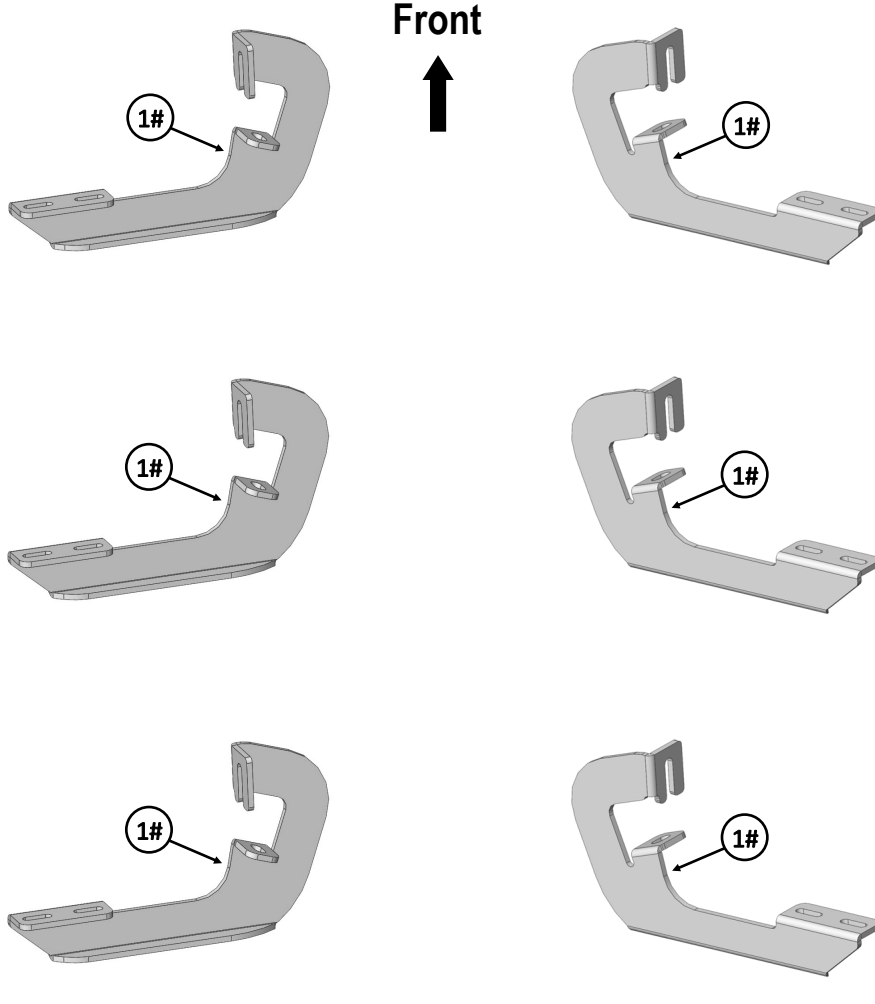

Passenger Side Step Bar

iBoard®

Mounting Bracket List					
Item	QTY	Description	Item	QTY	Description
1#	6	Mounting Brackets			

Hardware Package A (For Bracket Installation)					
Item	QTY	Description	Item	QTY	Description
1#	12	M8X1.25-30mm Hex Bolts	4#	6	M8X1.25 Hex Nuts
2#	18	M8 Flat Washers	5#	6	M8 Clip Nuts
3#	12	M8 Lock Washers			

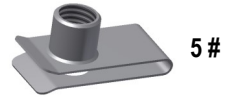
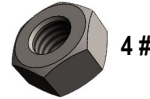

Hardware Package B (For Aluminum Step Bar Installation Only, Not Supply to SS. Step Bar)					
Item	QTY	Description	Item	QTY	Description
1#	12	M6X1-20mm Square Head Bolts	3#	12	M6X1 Nylon Lock Nuts
2#	12	M6 Large Flat Washers			

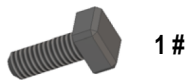

Hardware Package C (For Stainless Steel Step Bar Installation Only, Not Supply to Aluminum Step Bar)					
Item	QTY	Description	Item	QTY	Description
1#	12	M6X1-20mm Hex Bolts	3#	12	M6 Flat Washers
2#	12	M6 Lock Washers			



iBoard®

STEP 1

Starting on the driver side of the vehicle, locate the (2) holes in the bottom of the body panel, (pinch weld). Next locate the rectangular opening and (2) small holes in the inner body panel directly above the holes in the pinch weld, (**Fig 1**). Installation will use only the forward holes in each mounting location.

NOTE: The holes in the inner panel may be covered with sealing tape or insulation, remove as required.

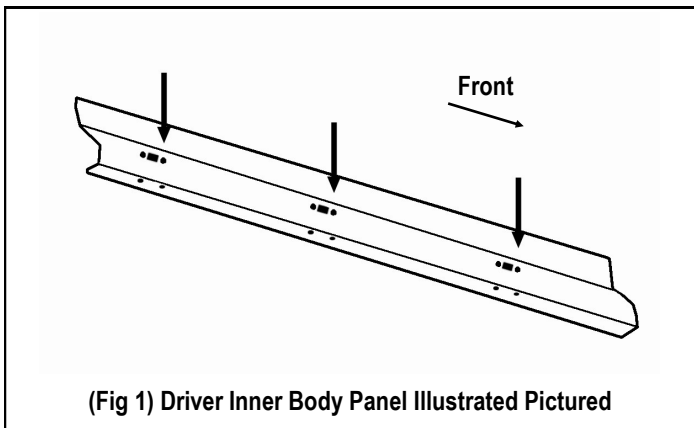

STEP 2

Slide (1) M8 Clip Nut into the rectangular opening with the nut towards the inside. Line up the threaded nut on the clip with the round hole toward the front of the vehicle, (**Fig 2**). Repeat to install an M8 Clip Nut in forward hole in the pinch weld. **NOTE:** If necessary, hold a mounting Bracket up in position to determine correct factory mounting holes location.

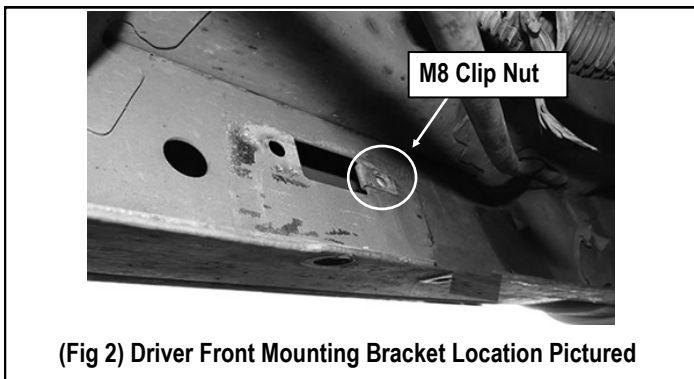

STEP 3

Select the Driver Front Mounting Bracket. Attach the Bracket to the (1) M8 Clip Nut with the included (1) M8X1.25-30mm Hex Bolt, (1) M8 Lock Washer and (1) M8 Flat Washer, and to the lower hole use (1) M8X1.25-30mm Hex Bolt, (1) M8 Lock Washer, (2) M8 Flat Washers and (1) M8X1.25 Hex Nut (**Fig 3**). Depending on model and year, the brake cable may be run on the inside or outside of the Bracket. Do not fully tighten hardware at this time.

NOTE: The cradle on the front Bracket should face to the rear of the vehicle.

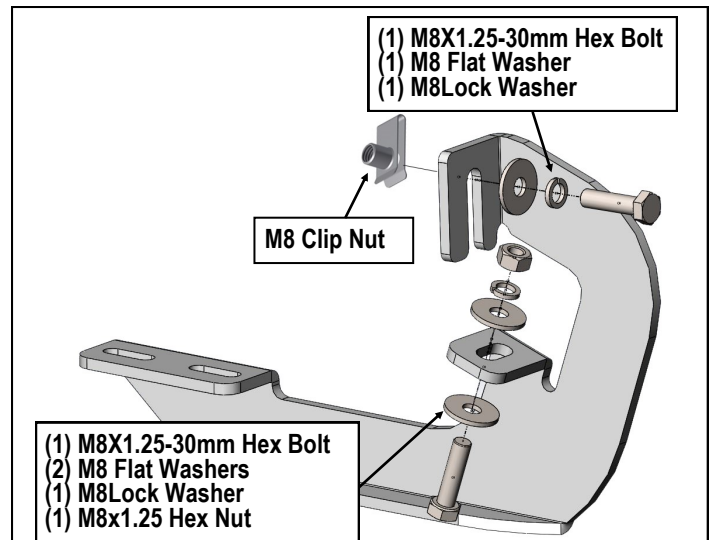

(Fig 3) Driver Front Mounting Bracket Installation

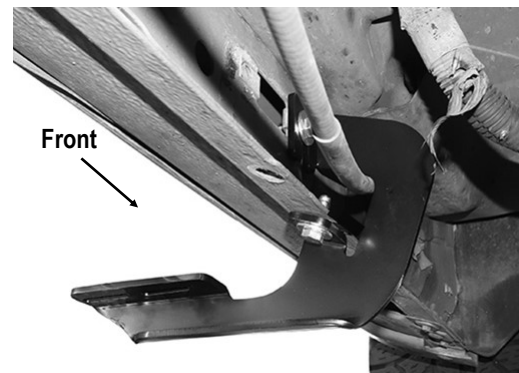

(Fig 4) Driver Front Mounting Bracket Installation

iBoard®

STEP 4

Next, move to the center & rear of the vehicle. Locate the (2) holes in the pinch weld similar to the front location, (Fig 5-6). Repeat **Steps 1-3** to install the Driver Center Mounting Bracket & Driver Rear Mounting Bracket .

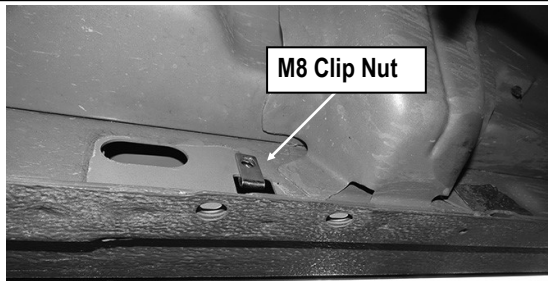

Front

(Fig 5) Driver Center Mounting Bracket Location Pictured

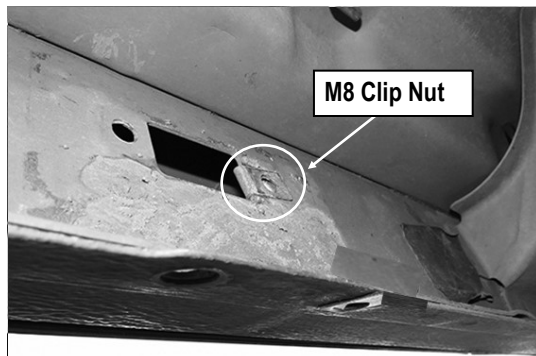

Front

(Fig 6) Driver Rear Mounting Bracket Location Pictured

STEP 5

Once all (3) mounting brackets are installed, then proceed to the Step Bar installation. According to the style of Step Bar proceed to the correct installation STEPS.

Note: Aluminum Step Bar refer to STEP 6; Stainless Steel Step Bar skip to STEP 7.

STEP 6

Aluminum Step Bar Installation:

Select a **Aluminum Step Bar**. Slip (3) M6x1-20mm Square Head Bolts into each bottom channel (Fig 7). Carefully position the Step Bar onto the (3) Mounting Brackets.

IMPORTANT: Do not slide the Step Bar on the Brackets or the bottom surface of the board will be damaged. Attach the Step Bar to each Mounting Brackets with (2) M6x1-20mm Square Head Bolts, (2) M6 Large Flat Washers and (2) M6X1 Nylon Lock Nuts, (Fig 8). Do not fully tighten at this time.

Level and adjust the Step Bar and fully tighten all hardware. Repeat **Steps 1-6** for the other side Step Bar installation. **The installation is completed!!!**



(Fig 7) Slip M6X1-20mm Square Head Bolts Into The Bottom Channels

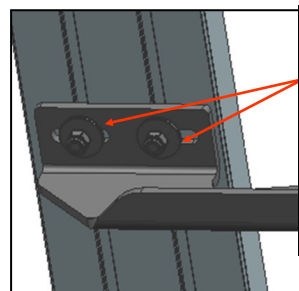

(2) M6X1-20mm Square Head Bolts
(2) M6 Large Flat Washers
(2) M6X1 Nylon Lock Nuts
IMPORTANT: TORQUE FOR 6MM FASTNERS MUST LESS THAN 6 -7 FT-LBS OR THE FASTNERS WILL BE DAMAGED!

(Fig 8) Running Board Installed Onto Mounting Bracket

iBoard®

STEP 7

Stainless Steel Step Bar Installation:

Select a **Stainless Steel Step Bar** (with the U-Sliders installed on the Bar). Loose the U-Sliders, reposition the U-Sliders onto the board according to the (3) Installed Mounting Brackets location, **(Fig 9)**. Re-secure the U-Sliders on the Step Bar. Attach the Step Bar to the installed Mounting Brackets with (6) M6X1-20mm Hex Bolts, (6) M6 Large Flat Washers & (6) M6 Lock Washers, **(Fig 10)**. Do not fully tighten hardware at this time. Level and adjust the Step Bar and fully tighten all hardware. Repeat **Steps 1-5 and 7** for the other side Step Bar installation. **The installation is completed!!!**



(Fig 9) Slide & line up the U-Slider with the installed mounting brackets along bottom channel

- (2) M6X1-20mm Hex Bolts
- (2) M6 Large Flat Washers
- (2) M6 Lock Washers

IMPORTANT: TORQUE FOR 6MM FASTNERS MUST LESS THAN 6-7 FT-LBS OR THE FASTNERS WILL BE DAMAGED!

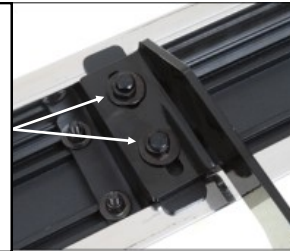

(Fig 10) Step Bar Installed on Bracket Installed (Example)

Attention

Do periodic inspections to the installation to make sure that all hardware is secure and tight.

In order to protect your bars/boards, please use only mild soap/non-abrasive products for cleaning.