

iBoard®

iBoard® by APS

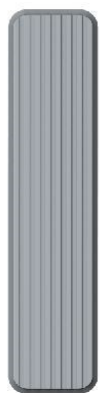
PART#: IB-405

READ INSTRUCTIONS CAREFULLY BEFORE STARTING INSTALLATION. REMOVE CONTENTS FROM BOX AND VERIFY ALL PARTS ARE PRESENT. ASSISTANCE IS RECOMMENDED.

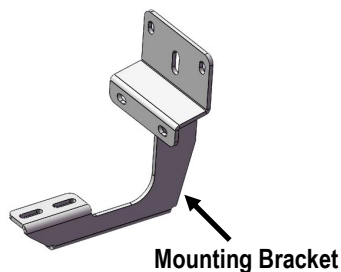
*ROCKER PANEL MOUNT
*DRILLING IS REQUIRED

Fastener Size	Tightening Torque (ft-lbs)	Required
6mm	6-7	√
8mm	16-18	√
10mm	31-32	√
12mm	56-58	X
14mm	92-94	X

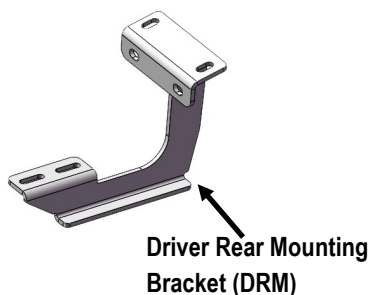
PART LIST



Driver Side

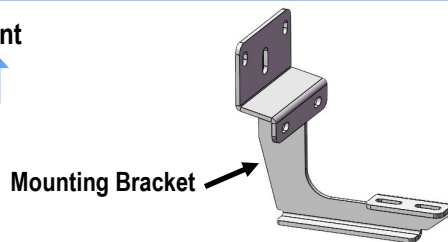


Mounting Bracket

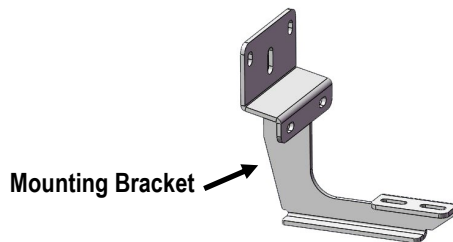


Driver Rear Mounting Bracket (DRM)

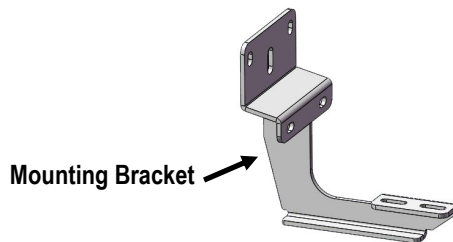
Front
↑



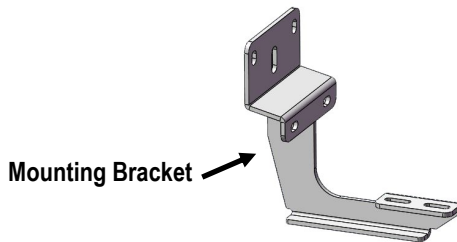
Mounting Bracket



Mounting Bracket



Mounting Bracket



Mounting Bracket



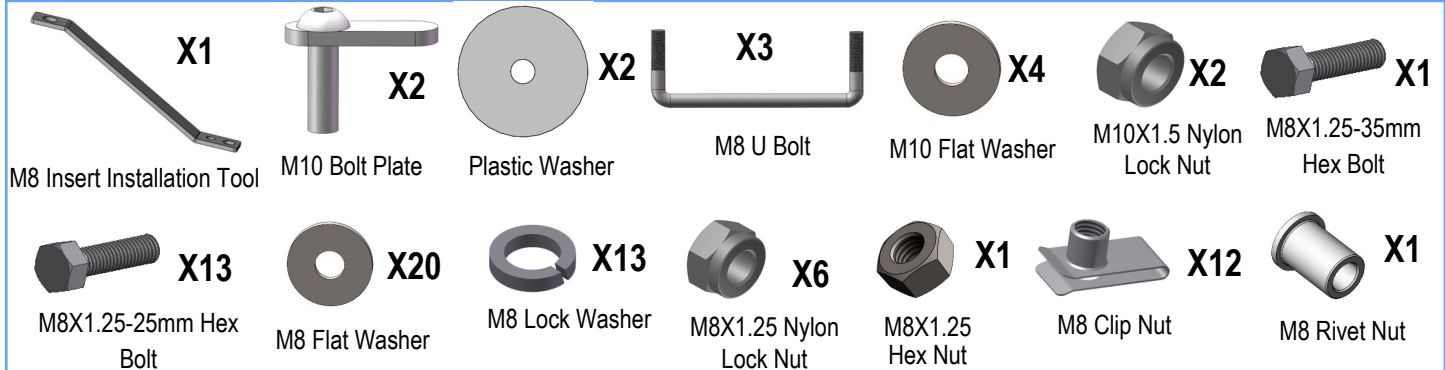
Passenger Side

Note: Driver Front Mounting Bracket and (4) Passenger Side Mounting Brackets are universal

Customer Support: info@iboardauto.com

iBoard®

Hardware Package A (For Bracket Installation)



Hardware Package B (For Aluminum Step Bar Installation Only, Not Supply to Stainless Steel Step Bar)



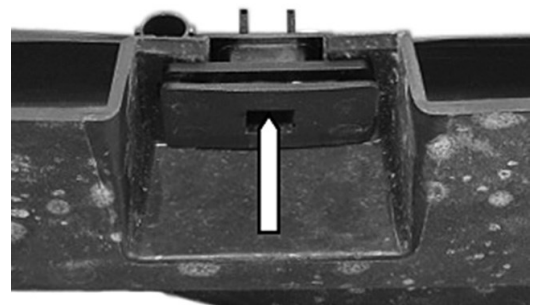
Hardware Package C (For Stainless Steel Step Bar Installation Only, Not Supply to Aluminum Step Bar)



STEP 1

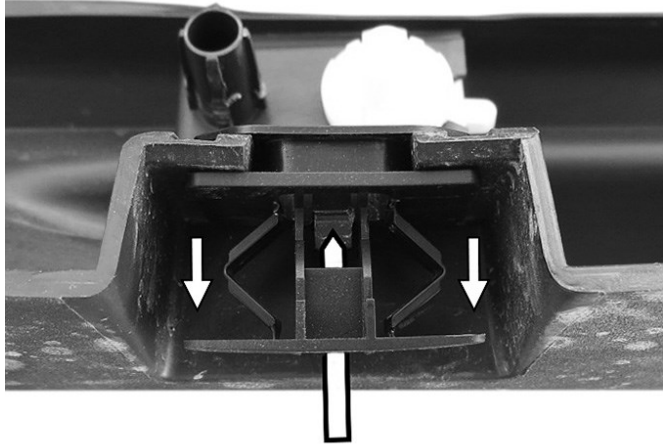
Starting installation from the passenger side front of the vehicle. Release the lower clips from the plastic trim along the bottom of the body, (Fig 1).

NOTE: From below, insert a small or medium sized flat screwdriver into the rectangular hole in the center of the clip. Carefully release each side (inside to outside, not front to back) of the plastic clip and pull the rectangular center pin down from the clip, (Fig 2). Do not twist the clip, gently pull it straight down once the clip is released. It is not necessary to completely remove the trim, only release the clips attaching the bottom of the trim to the vehicle.



(Fig 1) Insert Flat Screwdriver Into Square Opening to Release the Plastic Clip

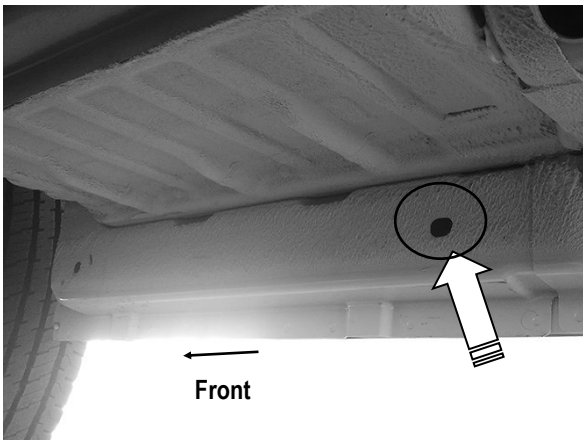
iBoard®



(Fig 2) Release Both Sides Of the Clip to Pull Out The Trim

STEP 2

Locate the factory hole approximately 24" back from the front of the body, (Fig 3). Remove excess undercoating from all mounting locations so that Brackets will install flat against body panel and pinch weld.

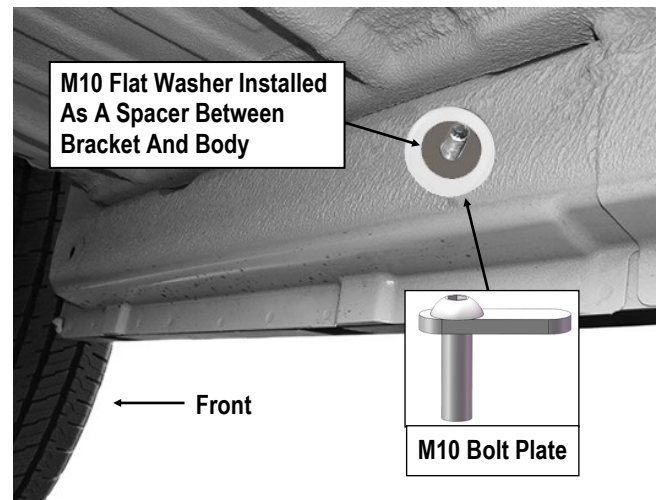


(Fig 3) Passenger Side Front Mounting Bracket Location

STEP 3

Select (1) M10 Bolt Plate, (1) M10 Flat Washer and (1) Plastic Washer. Thread the Plastic Washer onto the M10 Bolt Plate. Insert the M10 Bolt Plate into the hole and tighten the Plastic Washer against the body panel. Slide the M10 Flat Washer onto the end of the Bolt Plate, (Fig 4).

IMPORTANT: The Plastic Washer is designed to prevent the Bolt Plate from falling into the body panel within the Bracket installation. Do not fully tighten hardware at this time.



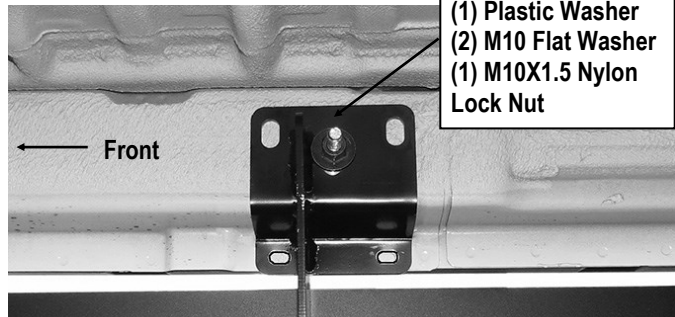
(Fig 4) M10 Bolt Plate Installed on the Passenger Side Front Mounting Location

STEP 4

Select (1) Mounting Bracket. Attach the Mounting Bracket to the installed M10 Bolt Plate with (1) M10 Flat Washer and (1) M10X1.5 Nylon Lock Nut, (Fig 5). Do not fully tighten hardware at this time.

Note: Line up the long slot in the center of the Bracket with the M10 Bolt Plate.

iBoard®



(Fig 5) Passenger Side Front Mounting Bracket Installation

STEP 5

Mark the location of the (2) bottom slots in the Bracket onto the pinch weld, (Fig 5). Remove the Bracket. Use a 3/8" drill bit to drill (2) holes through the pinch weld only, (Fig 6).

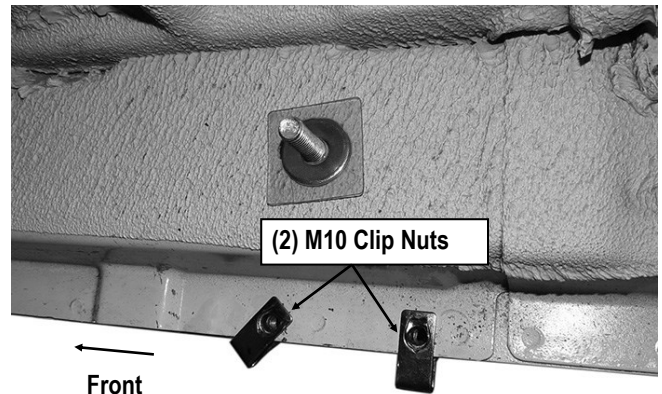
NOTE: Drill the holes as far away from the bottom edge of the pinch weld as possible.

IMPORTANT: Do not drill through the welds in the pinch weld. Slide the Bracket forward or back to move the slots away from the factory spot welds. Do not drill into or through the outer plastic rocker panel cover.

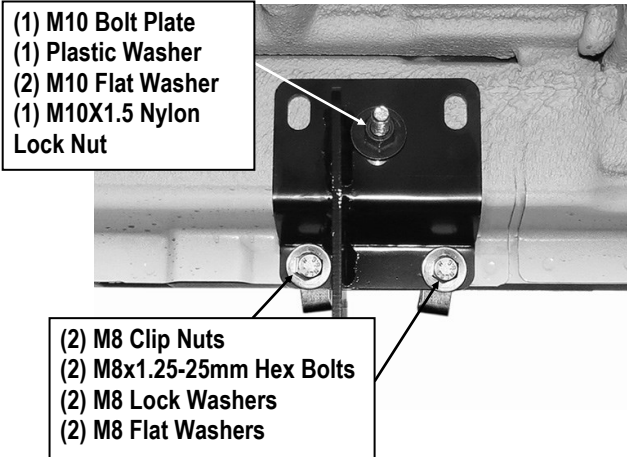
IMPORTANT! !! Any cutting or drilling tool may break or shatter. Government regulations require safety glasses & equipment at all times when cutting or drilling.

STEP 6

Select (2) M8 Clip Nuts. Slide the Clip Nuts over the pinch weld with the nut toward the outside, (Fig 6). Reattach the Bracket to the Bolt Plate and pinch weld with (2) M8X1.25-25mm Hex Bolts, (2) M8 Lock Washers and (2) M8 Flat Washers, (Fig 7). Do not fully tighten hardware at this time.



(Fig 6) Side The Clip Nuts Over The Pinch Weld



(Fig 7) Passenger Side Front Mounting Bracket Installation

STEP 7

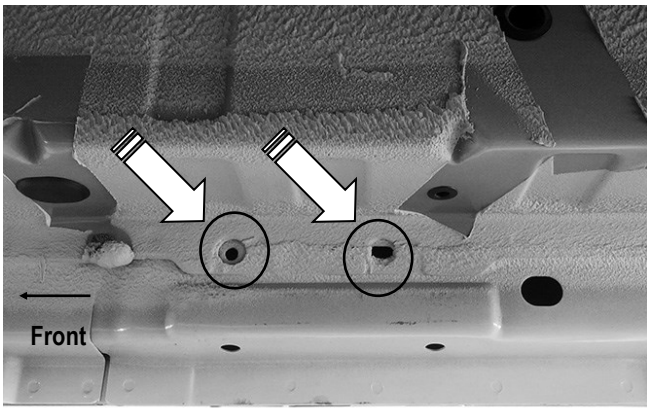
Move along the body to the 2nd mounting location. Determine if the vehicle is equipped with factory mounting studs along the body panel.

Models without factory studs:

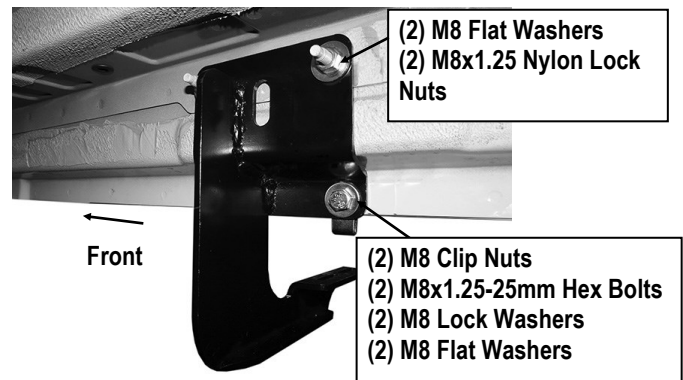
Locate the (2) factory holes in the side of the body panel, (Fig 8). Insert (1) M8 U Bolt into the (2) holes, (Fig 9). Select (1) Mounting Bracket, attach the Mounting Bracket to the U Bolt with (2) M8 Flat Washers and (2) M8X1.25 Nylon Lock Nuts, (Figs 10).

Repeat Steps 5 & 6 to drill and attach the Mounting Bracket to the inner of the pinch weld, (Fig 10 & 11).

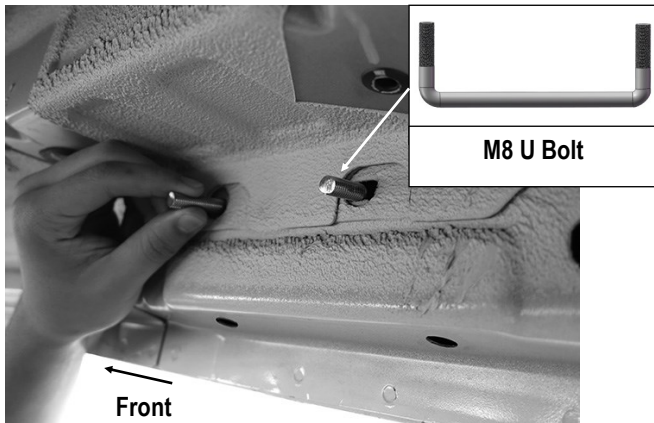
iBoard®



(Fig 8) Passenger Side 2nd Mounting Bracket Location



(Fig 11) Passenger Side 2nd Mounting Bracket Installation



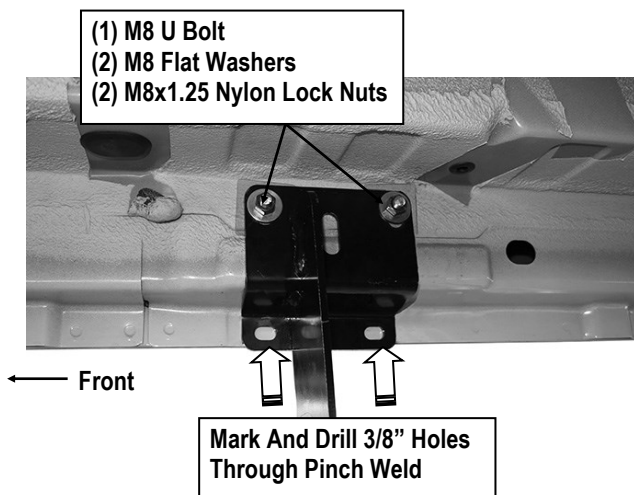
(Fig 9) Insert M8 U Bolt Into Factory Holes In Body Panel

Models with factory studs (Fig 12):

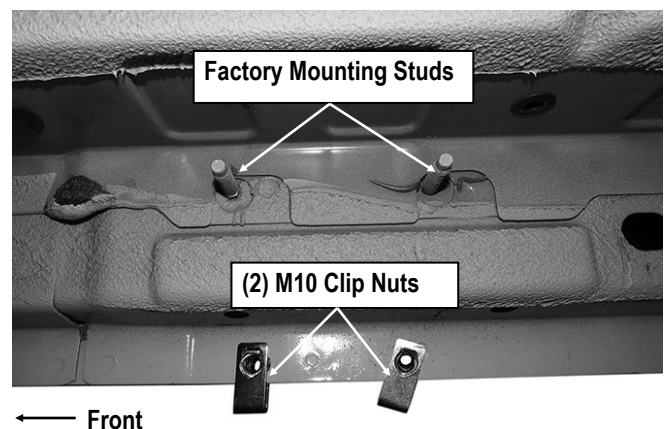
Attach (1) Mounting Bracket to the factory studs with (2) M8 Flat Washers and (2) M8x1.25 Nylon Lock Nuts.

Repeat **Steps 5 & 6**, mark and drill holes on the pinch weld, and then insert (2) M10 Clip Nuts into the drilled holes, (Fig 12). And reattach the Mounting Bracket to the pinch weld, (Fig 11).

Repeat to install (1) Mounting Bracket onto the 3rd mounting location, (Fig 13).

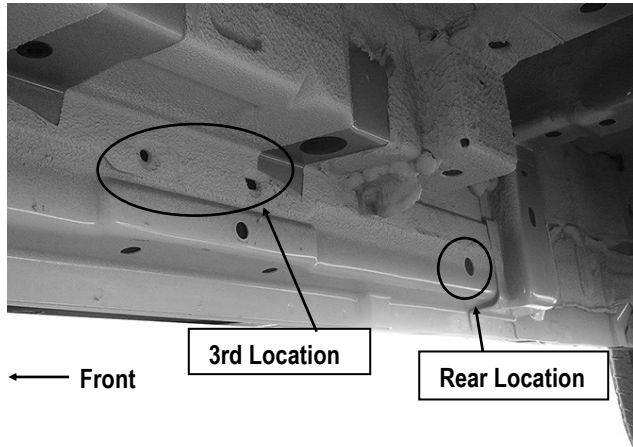


(Fig 10) Passenger Side 2nd Mounting Bracket Installation



(Fig 12) Passenger Side 2nd Mounting Bracket Location

iBoard®



(Fig 13) Passenger Side 3rd/Rear Mounting Bracket Location

STEP 8

Move to the passenger side rear of the vehicle, (Fig 11). Repeat **Steps 2—6** to install (1) Mounting Bracket in the passenger side rear mounting location.

STEP 9

Once all (4) mounting brackets are installed, then proceed to the Step Bar installation. According to the style of Step Bar proceed to the correct installation STEPS.

Note: Aluminum Step Bar refer to STEP 10; Stainless Steel Step Bar skip to STEP 11.

STEP 10

Aluminum Step Bar Installation:

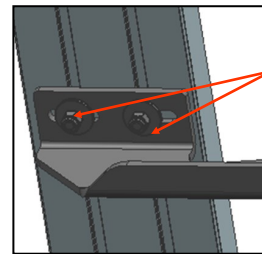
Select a **Aluminum Step Bar**. Slip (4) M6x1-20mm Square Head Bolts into each bottom channel (Fig 14). Carefully position the Step Bar onto the (4) Mounting Brackets.

IMPORTANT: Do not slide the Step Bar on the Brackets or the

bottom surface of the board will be damaged. Attach the Step Bar to each Mounting Brackets with (2) M6x1-20mm Square Head Bolts, (2) M6 Large Flat Washers and (2) M6x1 Nylon Lock Nuts, (Fig 15). Do not fully tighten at this time. Level and adjust the Step Bar and fully tighten all hardware. Repeat **Steps 1-10** for the other side Step Bar installation.



(Fig 14) Slip M6X1-20mm Square Head Bolts Into The Bottom Channels



(2) M6X1-20mm Square Head Bolts
(2) M6 Large Flat Washers
(2) M6X1 Nylon Lock Nuts
IMPORTANT: TORQUE FOR 6MM FASTENERS MUST LESS THAN 6-7 FT-LBS OR THE FASTENERS WILL BE DAMAGED!

(Fig 15) Running Board Installed Onto Mounting Bracket

STEP 11

Stainless Steel Step Bar Installation:

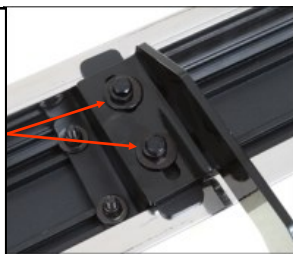
Select a **Stainless Steel Step Bar** (with the U-Sliders installed on the Bar). Loose the U-Sliders, reposition the U-Sliders onto the board according to the (4) Installed Mounting Brackets location, (Fig 16). Re-secure the U-Sliders on the Step Bar. Attach the Step Bar to the installed Mounting Brackets with (8) M6X1-20mm Hex Bolts, (8) M6 Large Flat Washers & (8) M6 Lock Washers, (Fig 17). Do not fully tighten hardware at this time. Level and adjust the Step Bar and fully tighten all hardware. Repeat **Steps 1-9 and 11** for the other side Step Bar installation.

iBoard®



(Fig 16) Slide & line up the U-Slider with the installed mounting brackets along bottom channel

(2) M6X1-20mm Hex Bolts
(2) M6 Large Flat Washers
(2) M6 Lock Washers
IMPORTANT: TORQUE FOR 6MM FASTENERS MUST LESS THAN 6-7 FT-LBS OR THE FASTNERS WILL BE DAMAGED!



(Fig 17) Step Bar Installed on Bracket Installed (Example)

STEP 12

Level and adjust the Running Board and fully tighten all hardware.

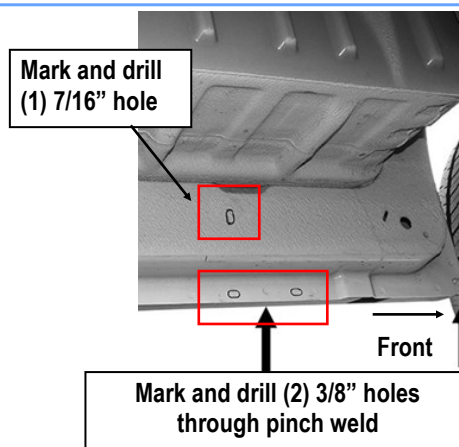
Reinstall the plastic trim along the bottom of the body. **IMPORTANT: Minor trimming may be required around M8 Clip Nuts. Temporarily remove the Running Board. Use a sharp knife or hacksaw blade to trim plastic as required.**

STEP 13

Move to the driver side front of the vehicle. Repeat **Step 1, (Fig 1 & 2)**, to release the clips attaching the plastic trim to the bottom of the driver side. Identify the front bracket mounting location approximately 10" away from the front edge of the body panel, (**Fig 18**).

Select (1) Mounting Bracket. Hold the Mounting Bracket firmly in position against the body panel and pinch weld. Mark the upper left hole location onto the inner body panel. Also mark the (2) lower mounting locations onto the pinch weld and the drill holes according to the marks, (**Fig 18**).

IMPORTANT: Do not drill through the welds in the pinch weld. Slide the Bracket forward or back to move the slots away from the factory spot welds. Do not drill into or through the outer plastic rocker panel cover.



(Fig 18) Driver Side Front Mounting Bracket Location

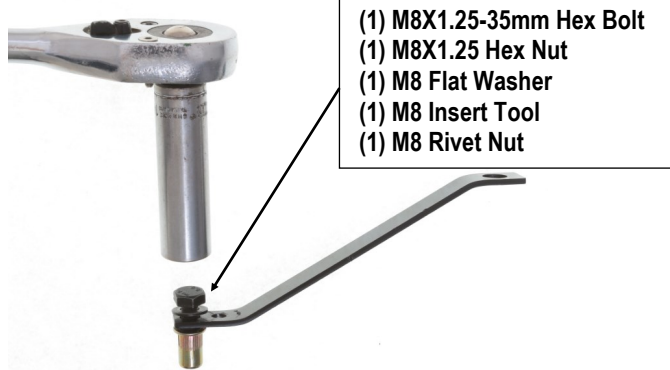
STEP 14

Select (1) M8 Rivet Nut, (1) M8X1.25-35mm Hex Bolt, (1) M8 Hex Nut, (1) M8 Flat Washer and (1) M8 Insert Tool. Thread the M8 Hex Nut onto the M8 Hex Bolt. Assemble the M8 Insert Tool as pictured in **Fig 19**.

NOTE: Select 8mm hole on M8 Insert Tool (**Fig 20**). Use a 13mm wrench to hold the M8 Hex Bolt to prevent it from spinning. Turn the M8 Hex Nut counter-clockwise to pull/expand the insert in the hole, (**Fig 21**). Tighten the M8 Hex Nut until the Insert is fully installed, (**Figs 19 & 22**). Do not over tighten the M8 Hex Nut.

Bolt the Mounting Bracket to the M8 Rivet Nut with (1) M8x1-25mm Hex Bolt, (1) M8 Lock Washer and (1) M8 Flat Washer, (**Fig 23**).

iBoard®

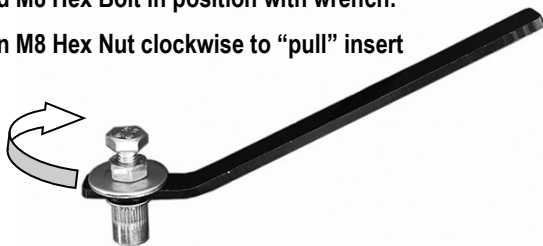


(Fig 19) M8 Insert Tool Assembly

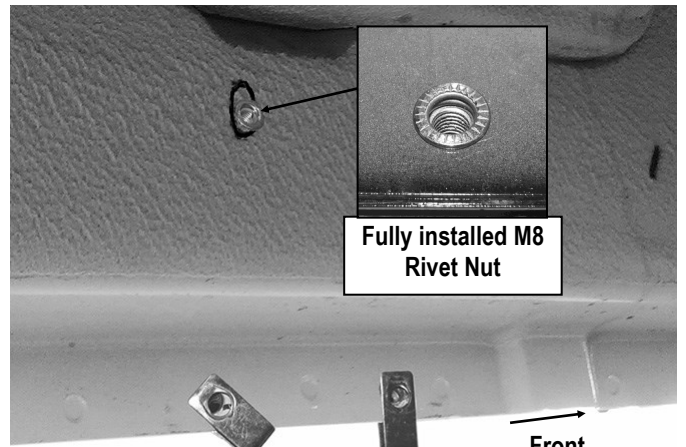


Fig 20

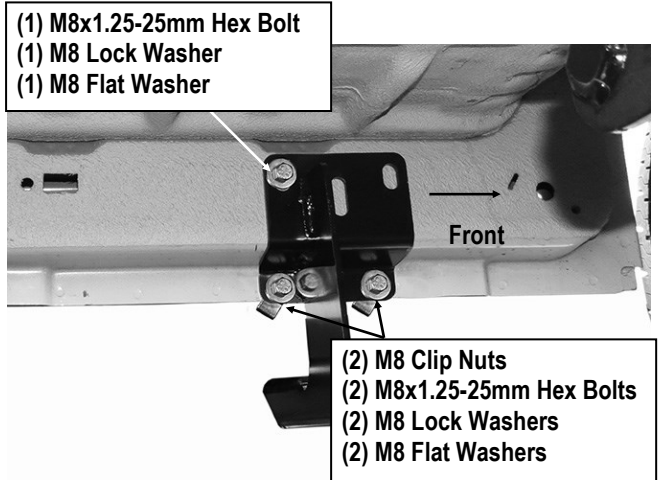
Hold M8 Hex Bolt in position with wrench.
Turn M8 Hex Nut clockwise to “pull” insert



(Fig 21) M8 Insert Tool Assembly



(Fig 22) Driver Side Front Mounting Location



(Fig 23) Driver Front Mounting Bracket Installed

STEP 15

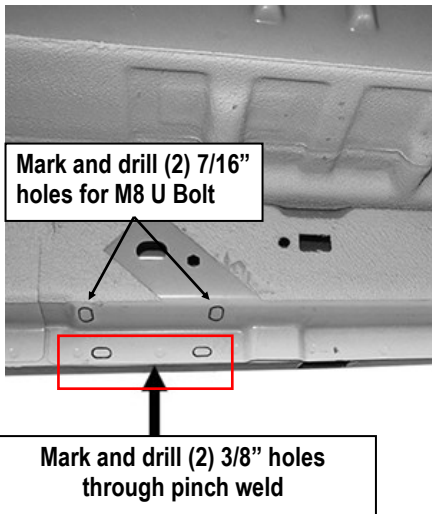
Insert (2) M8 Clip Nuts into the drilled holes on pinch weld, (Fig 22). Attach Mounting Bracket to the installed M8 Rivet Nut on body panel, (Fig 23). Secure the lower mounting holes to the installed (2) M8 Clip Nuts on pinch weld with (2) M8X1.25-25mm Hex Bolts, (2) M8 Lock Washers and (2) M8 Flat Washers, (Fig 23). Do not fully tighten hardware at this time.

STEP 16

Move to the driver side rear mounting location (approximately 24” away from the front edge of the body panel), (Fig 24). Select the Driver Rear Mounting Bracket (DRM). Hold the Bracket firmly against the bottom of the body panel and pinch weld. Mark and drill holes as shown on Fig 24.

NOTE: Slide the Bracket forward as necessary to avoid drilling through any factory welds on the pinch weld.

iBoard®

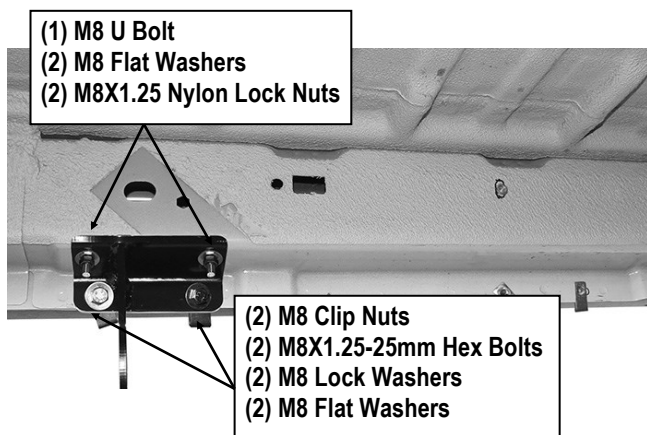


(Fig 24) Driver Side Rear Mounting Location

STEP 17

Insert (1) M8 U Bolt into the (2) drilled 7/16" holes. And insert (2) M8 Clip Nuts into the (2) drilled 3/8" holes on pinch weld.

Select (1) Driver Rear Mounting Bracket (**DRM**). Attach the upper slots on the Bracket to the installed M8 U Bolt with (2) M8 Flat Washers and (2) M8X1.25 Nylon Lock Nuts. Secure the lower holes of the mounting bracket to the installed (2) M8 Clip Nuts on pinch weld with (2) M8X1.25-25mm Hex Bolts, (2) M8 Lock Washers, (2) M8 Flat Washers (**Fig 25**). Do not fully tighten hardware at this time.



(Fig 25) Driver Rear Mounting Bracket (DRM) Installed

STEP 18

Select the driver side Running Board. Repeat **Steps 9- 12** to attach the Running Board to the (2) Brackets.

NOTE: Just need (4) M6x1-20mm Square Head Bolts and (4) M6 Large Flat Washers and (4) M6x1 Nylon Lock Nuts for the driver side running board installation.

STEP 19

Level and adjust the Running Board and fully tighten all hardware.

Reinstall the plastic trim along the bottom of the body.

IMPORTANT: Minor trimming may be required around M8 Clip Nuts. Temporarily remove the Running Board. Use a sharp knife or hacksaw blade to trim plastic as required.

The installation is completed.

Attention

Do periodic inspections to the installation to make sure that all hardware is secure and tight.

In order to protect your bars/boards, please use only mild soap/non-abrasive products for cleaning.