

iBoard®



Scan for
Installation Video

iBoard® by APS

PART#: IB-188S&189L C&H

READ INSTRUCTIONS CAREFULLY BEFORE STARTING INSTALLATION. REMOVE CONTENTS FROM BOX AND VERIFY ALL PARTS ARE PRESENT. ASSISTANCE IS RECOMMENDED.

*ROCKER PANEL MOUNT
*NO DRILLING REQUIRED/ TRIMMING MAY BE REQUIRED

Fastener Size	Tightening Torque (ft-lbs)	Required
6mm	6-7	X
8mm	16-18	√
10mm	31-32	√
12mm	56-58	X
14mm	92-94	X

PART LIST

Driver Side Step Bar

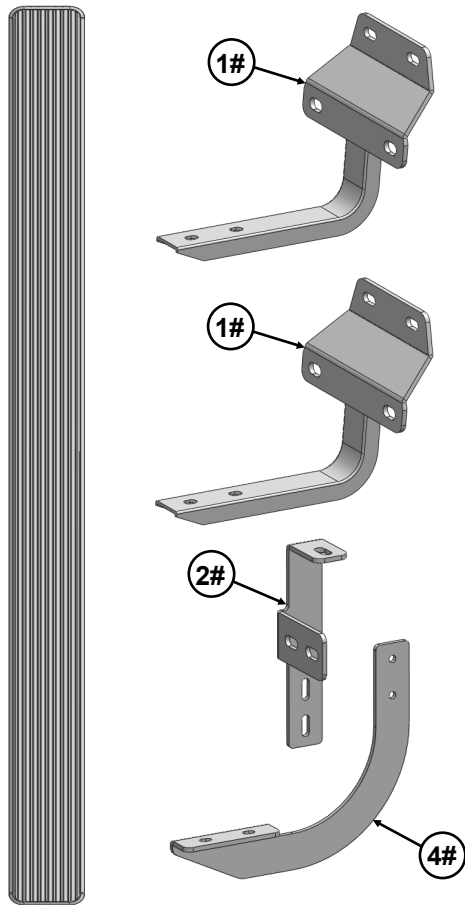

Front



Passenger Side Step Bar

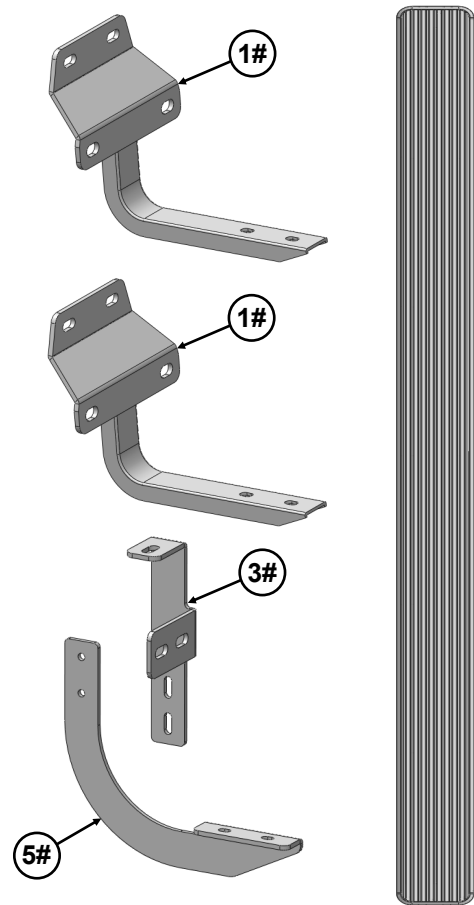



Customer Support: info@iboardauto.com



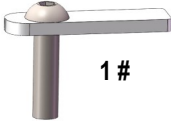

Mounting Bracket List					
Item	QTY	Description	Item	QTY	Description
1#	4	Mounting Brackets	4#	1	Driver Rear Bar Bracket
2#	1	Driver Rear Mounting Bracket	5#	1	Passenger Rear Bar Bracket
3#	1	Passenger Rear Mounting Bracket			

Hardware Package A (For Bracket Installation)					
Item	QTY	Description	Item	QTY	Description
1#	2	M10X40 Bolt Plates	7#	4	M10X1.5 Hex Nuts
2#	2	M10X35 T-Bolt Plates	8#	20	M8 Large Flat Washers
3#	12	M8 Plastic Washers	9#	12	M8 Nylon Lock Nuts
4#	8	M10 Plastic Washer	10#	4	M8X1.25-25mm Hex Bolts
5#	4	M10 Large Flat Washers	11#	4	M8 Lock Washers
6#	4	M10 Lock Washers	12#	4	M8X1.25 Hex Nuts



1 #



2 #



3 #



4 #



5 #



6 #

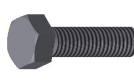

7 #

8 #



9 #



10 #

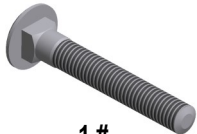

11 #



12 #

Hardware Package B (For Stainless Steel Step Bar Installation)					
Item	QTY	Description	Item	QTY	Description
1#	12	M8X1.25-35mm Carriage Bolts	3#	12	M8 Nylon Lock Nuts
2#	12	M8 Large Flat Washers	4#	6	Sliders (Packed with Step Bars)

1 #

2 #

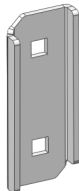

3 #

4 #

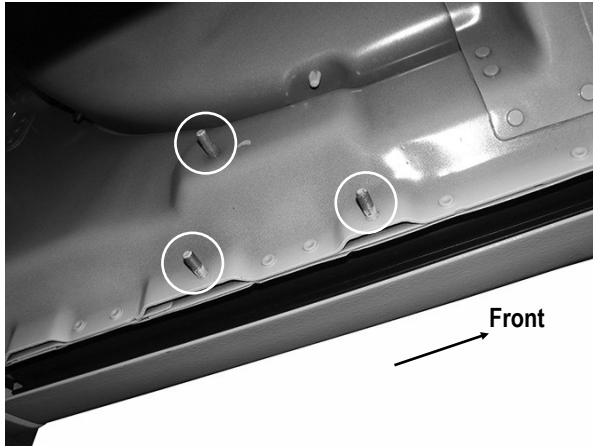

STEP 1

Start the installation under the driver side of the vehicle. Locate the Driver Side Front Mounting Location along the inner side of the body panel, (Fig 1).



(Fig 1) Driver Side Front Mounting Location

STEP 2

Slide (1) M8 Plastic Washer over each factory mounting stud on the body panel, (Fig 2).

IMPORTANT: The Plastic Washers are designed to prevent corrosion between the body panel and the mounting brackets. Do not install the Brackets without the Plastic Washers.

STEP 3

Select (1) Mounting Bracket. Attach the Mounting Bracket to the (3) factory studs with (3) M8 Large Flat Washers and (3) M8X1.25 Nylon Lock Nuts, (Figs 3 & 4). Do not fully tighten hardware at this time.

NOTE: The (4) Mounting Brackets are universal and will fit driver and passenger side front/center mounting locations.

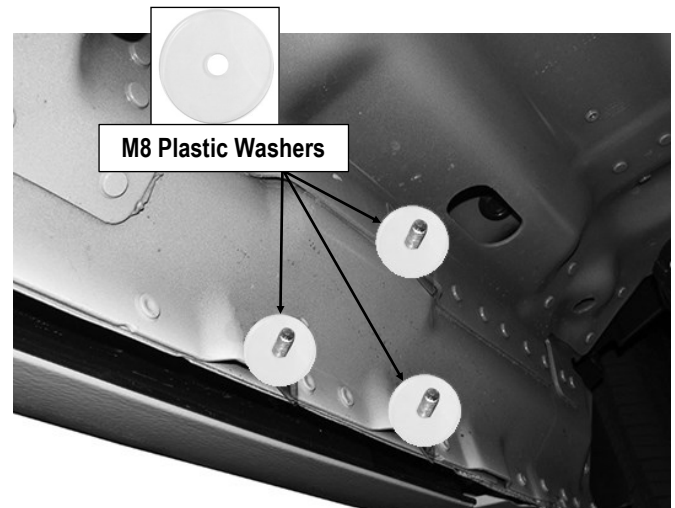

(Fig 2) M8 Plastic Washers Installed on Factory Mounting Studs

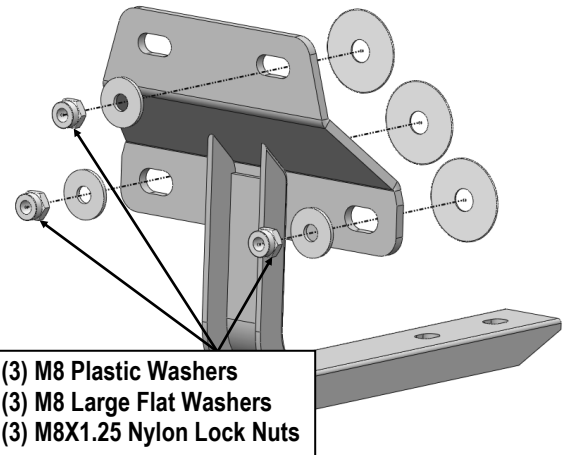

(Fig 3) Driver Front Mounting Bracket Installation

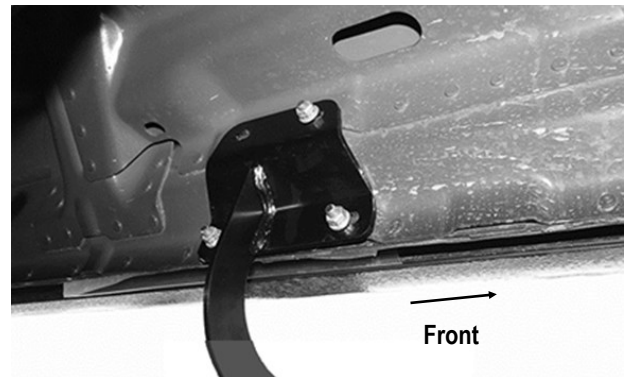

(Fig 4) Driver Front Mounting Bracket Installed



STEP 4

Repeat **Steps 1—3** to install the Mounting Bracket onto the Driver Side Center Mounting Location, (**Fig 5**). Do not fully tighten hardware at this time.

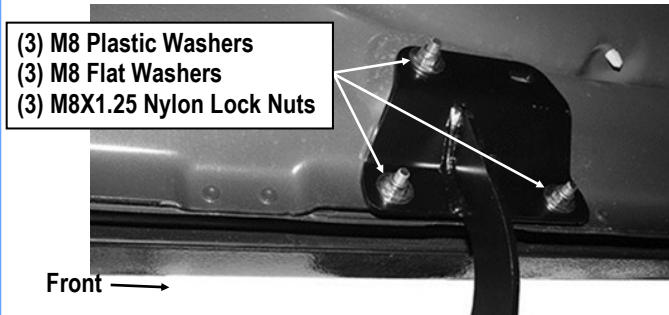

(Fig 5) Driver Center Mounting Bracket Installed

STEP 5

Move to the Driver Side Rear Mount Location at the rear of the cab. Locate the oval hole beside the body mount and the square hole on the body panel, (**Fig 6**). Thread (1) M10 Plastic Washer onto (1) M10X35 T-Bolt Plate, (**Fig 7**).

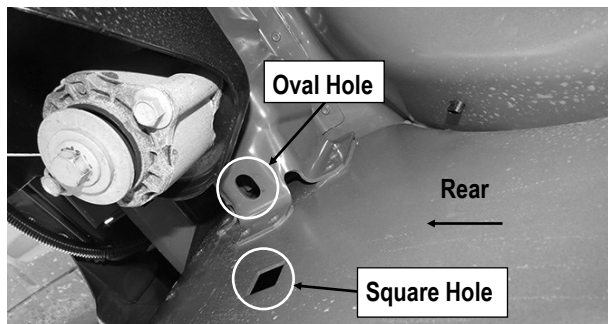

(Fig 6) Driver Side Rear Mounting Location

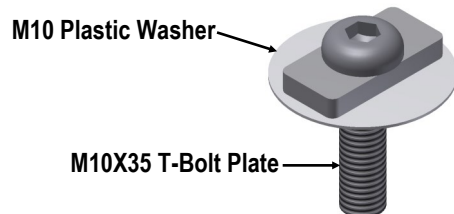

(Fig 7) Threaded M10 Plastic Washer onto M10X35 T-Bolt Plate

STEP 6

Insert the M10X35 T-Bolt Plate (with M10 Plastic Washer) into the oval hole beside the rear body mount. Bend the M10 Plastic Washer if required, (**Fig 8**). Once the T-Bolt Plate is inserted into the oval hole, thread another M10 Plastic Washer onto the T-Bolt Plate to hold the T-Bolt Plate in place, (**Fig 8**).



(Fig 8) Insert M10X35 T-Bolt W/ Plastic Washer into oval hole.
Thread another M10 Plastic Washer onto T-Bolt

STEP 7

Locate the square hole on the side of the body panel, (**Fig 6**). Select (1) M10X40 Bolt Plate & (1) M10 Plastic Washer. Thread the Plastic Washer to the Bolt Plate, insert the Bolt Plate (with Plastic Washer) into the square hole (Bend the Plastic Washer if required), (**Fig 9**). Thread another M10 Plastic Washer onto the Bolt Plate to hold the Bolt Plate in place, (**Fig 10**).

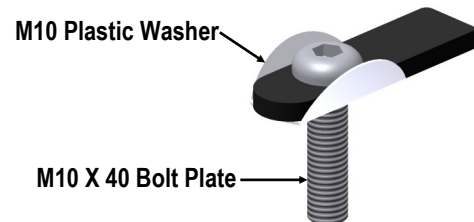

(Fig 9) Insert the Bolt Plate into the square hole
(If required, bend the Plastic Washer up)

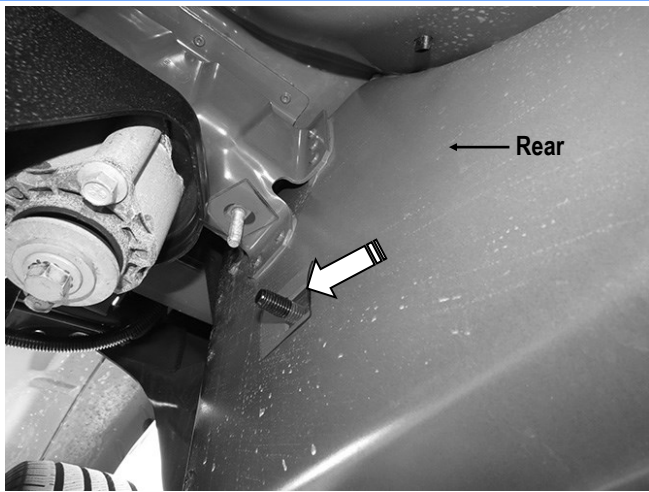

(Fig 10) Insert M10X40 Bolt Plate W/Plastic Washer into square hole. Thread another Plastic Washer onto Bolt Plate

STEP 8

Assemble Driver Rear Mounting Bracket and Driver Rear Bar Bracket with (2) M8X1.25-25mm Hex Bolts, (4) M8 Flat Washers, (2) M8 Lock Washers and (2) M8X1.25 Hex Nuts, (Fig 11). Do not fully tighten hardware at this time.

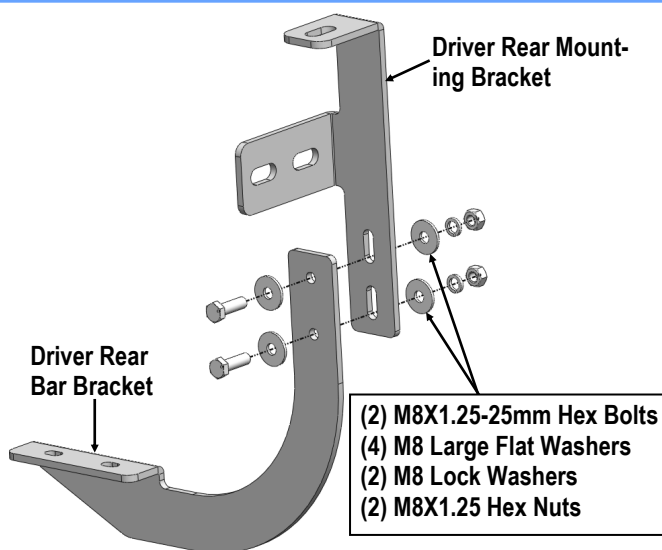

(Fig 11) Driver Rear Mounting Bracket and Driver Rear Bar Bracket Assembly

STEP 9

Attach the assembled Driver Rear Mounting Bracket to the (2) installed M10 Bolt Plates with (2) M10 Large Flat Washers, (2) M10 Lock Washers and (2) M10X1.5 Hex Nuts, (Fig 12). Do not fully tighten hardware at this time.

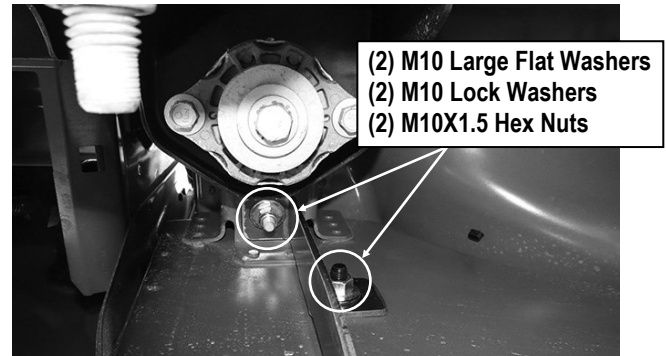

(Fig 12) The Assembled Driver Rear Mounting Bracket Installed

STEP 10

Once all (3) Driver side mounting brackets are installed, then proceed to the Step Bar installation. (Figs 13 & 14)

- (1) Select (1) Slider and (2) M8X1.25-35mm Carriage Bolts;
- (2) Install (2) M8X1.25-35mm Carriage Bolts in (1) Slider.
- (3) Slide the Slider (with carriage bolts) to the **Step Bar**.
- (4) Repeat to install the other (2) sliders to the step bar.
- (5) Attach the Step Bar (with the Sliders) onto the installed mounting brackets. Position the Sliders to the installed brackets. Secure the Step Bar to the installed Brackets by using (6) M8 Large Flat Washers and (6) M8 Nylon Lock Nuts and (3) Sliders, (Fig 14). Do not fully tighten hardware at this time.

Note: The Sliders are packed with the Step Bars.

Level and adjust the Step Bar and fully tighten all hardware.

Repeat **Steps 1-10** for the other side Step Bar installation. **The installation is completed!!!**



Scan for
Installation Video

