

iBoard®



Scan for
Installation Video

iBoard® by APS

PART#: IB-177C&H

READ INSTRUCTIONS CAREFULLY BEFORE STARTING INSTALLATION. REMOVE CONTENTS FROM BOX AND VERIFY ALL PARTS ARE PRESENT. ASSISTANCE IS RECOMMENDED.

*ROCKER PANEL MOUNT
*NO DRILLING REQUIRED

Fastener Size	Tightening Torque (ft-lbs)	Required
6mm	6-7	X
8mm	16-18	√
10mm	31-32	X
12mm	56-58	X
14mm	92-94	X

PART LIST

Driver Side Step Bar

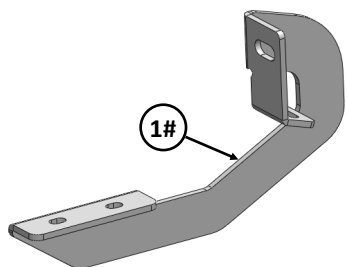
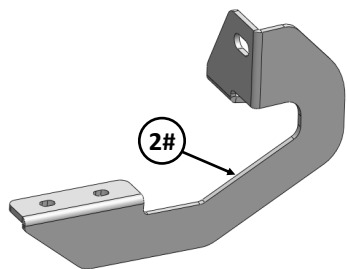
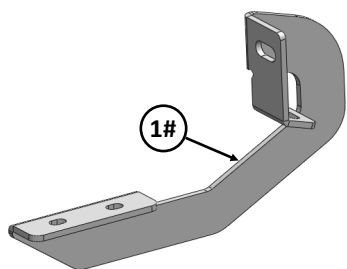
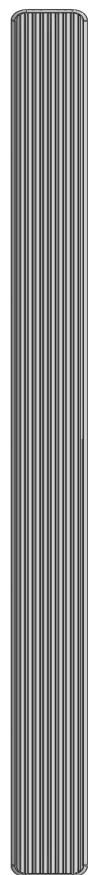

Front



Passenger Side Step Bar

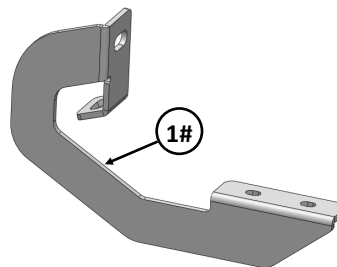
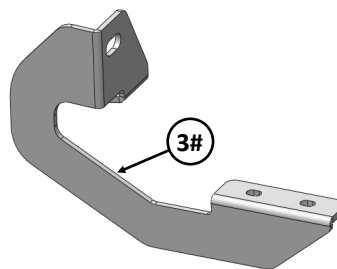
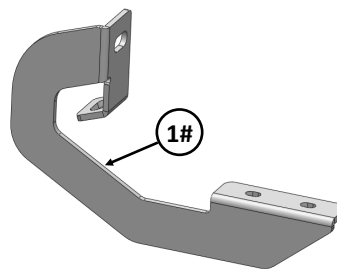
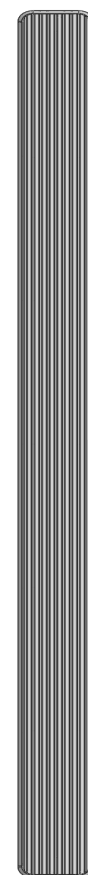



Customer Support: info@iboardauto.com





Mounting Bracket List					
Item	QTY	Description	Item	QTY	Description
1#	4	Mounting Brackets	3#	1	Passenger Center Mounting Bracket
2#	1	Driver Center Mounting Bracket			

Hardware Package A (For Bracket Installation)					
Item	QTY	Description	Item	QTY	Description
1#	6	M8X1.25 - 30mm Hex Bolts	5#	12	M8 Lock Washers
2#	6	M8x1.25 - 25mm Hex Bolts	6#	6	M8 Hex Nuts
3#	12	M8 Flat Washers	7#	6	M8 Clip Nuts
4#	6	M8 Large Flat Washers			

 1 #

 2 #

 3 #

 4 #

 5 #

 6 #

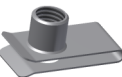
 7 #

Hardware Package B (For Stainless Steel Step Bar Installation)					
Item	QTY	Description	Item	QTY	Description
1#	12	M8X1.25-35mm Carriage Bolts	3#	12	M8 Nylon Lock Nuts
2#	12	M8 Large Flat Washers	4#	6	Sliders (Packed with Step Bars)

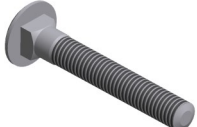
 1 #

 2 #

 3 #

 4 #



STEP 1

Starting on the driver side of the vehicle, locate the (2) holes in the bottom of the body panel, (pinch weld), toward the front tire, **(Fig 1)**. Next locate the rectangular opening and (2) small holes in the inner body panel directly above the holes in the pinch weld, **(Fig 1 & 2)**. **NOTE:** The holes in the inner panel may be covered with sealing tape or insulation.

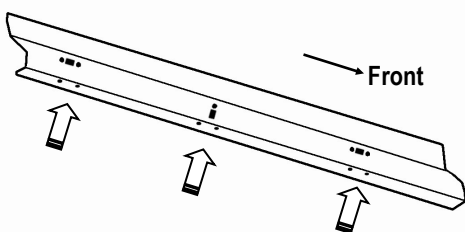

(Fig 1) Driver Inner Body Panel Illustrated (Locate Holes Through Pinch Weld Arrows To Determine Mounting Locations)

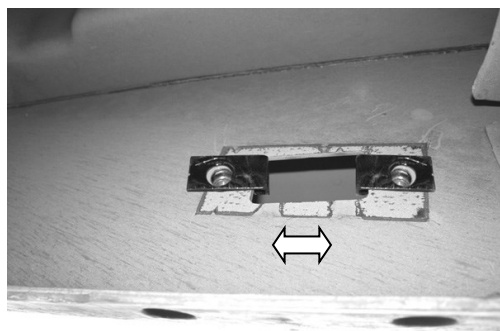

(Fig 2) Slide M8 Clip Nuts Over Holes

STEP 2

Slide (1) M8 Clip Nut into the rectangular opening with the nut towards the inside. Line up the threaded nut on the clip with the round hole, **(Fig 2)**. Repeat to install the 2nd M8 Clip Nut in remaining hole location.

STEP 3

Select (1) Driver Front Mounting Bracket. **NOTE: All (4) Front & Rear Mounting Brackets are universal.** Attach the Bracket to the (1) M8 Clip Nuts with the included (1) M8X1.25-30mm Hex Bolt, (1) M8 Lock Washer and (1) M8 Large Flat Washer, **(Fig 3)**. Depending on model and year, the brake cable may be run on the inside or outside of the Bracket. Do not tighten hardware at this time. **NOTE:** The cradle on the front Bracket should face to the rear of the vehicle.

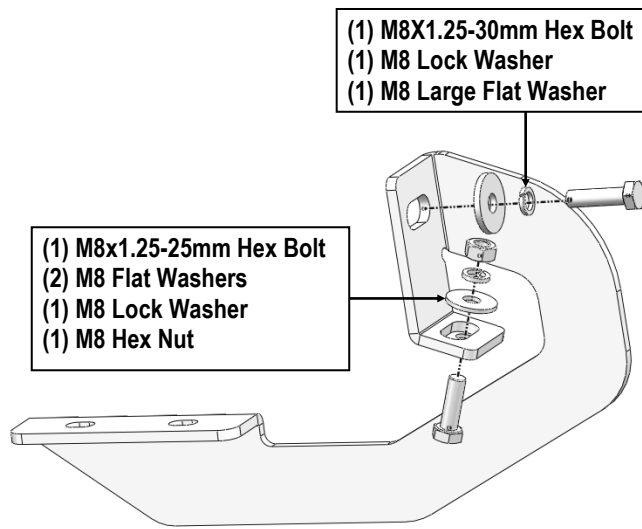

(Fig 3) Driver Front Mounting Bracket Installation

STEP 4

Align the bottom holes in the front Bracket with the (1) holes in the pinch weld. Bolt the Bracket to the pinch weld using the included (1) M8X1.25-25mm Hex Bolt, (2) M8 Flat Washers, (1) M8 Lock Washer and (1) M8 Hex Nut, **(Fig 3)**.

NOTE: Insert the bolts up from the bottom of the pinch weld and through the Bracket.



STEP 5

Next, move toward the center of the vehicle. Locate the (2) holes in the pinch weld similar to the front location, Insert (1) M8 Clip Nut into the rectangular opening and up to the single small round hole in the body panel, **(Fig 4)**.

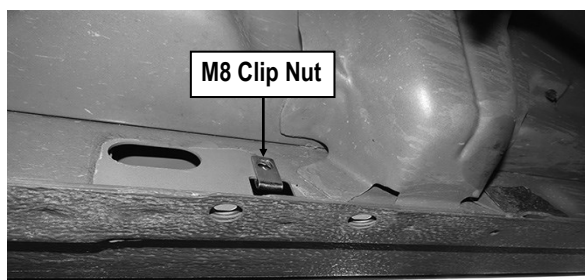

(Fig 4) Driver Center Mounting Bracket Location

STEP 6

Select Driver Center Mounting Bracket. Attach the Bracket to the M8 Clip Nut with (1) M8X1.25-30mm Hex Bolt, (1) M8 Lock Washer and (1) M8 Large Flat Washer, **(Fig 5)**. Line up the hole in the Bracket with the hole in the pinch weld. Bolt the Bracket to the pinch weld with (1) M8x1.25-25mm Hex Bolt, (2) M8 Flat Washers, (1) M8 Lock Washer and (1) M8 Hex Nut. Do not tighten hardware at this time.

NOTE: The cradle on the center mounting Bracket will face the front of the vehicle.

STEP 7

Continue along the cab to the rear mounting location. Repeat **Steps 1—4** for Driver Rear Mounting Bracket installation.

NOTE: The cradle on the rear Bracket should face the front of the vehicle.

(1) M8X1.25-30mm Hex Bolts
(1) M8 Lock Washers
(1) M8 Large Flat Washers

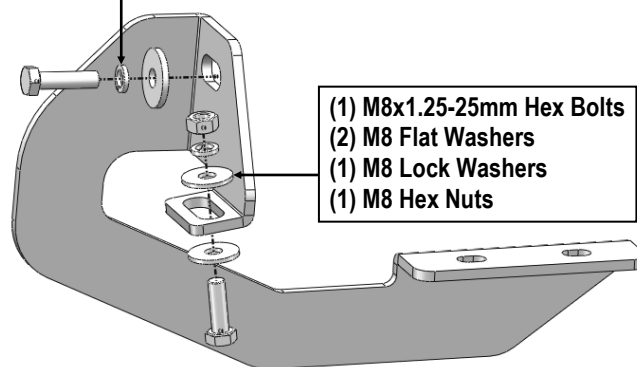

(1) M8x1.25-25mm Hex Bolts
(2) M8 Flat Washers
(1) M8 Lock Washers
(1) M8 Hex Nuts

(Fig 5) Driver Center Mounting Bracket Installation

STEP 8

Once all (3) Driver side mounting brackets are installed, then proceed to the Step Bar installation. **(Figs 6 & 7)**

(1) Select (1) Slider and (2) M8X1.25-35mm Carriage Bolts;

(2) Install (2) M8X1.25-35mm Carriage Bolts in (1) Slider.

(3) Slide the Slider (with carriage bolts) to the **Step Bar**.

(4) Repeat to install the other (2) sliders to the step bar.

(5) Attach the Step Bar (with the Sliders) onto the installed mounting brackets. Position the Sliders to the installed brackets. Secure the Step Bar to the installed Brackets by using (6) M8 Large Flat Washers and (6) M8 Nylon Lock Nuts and (3) Sliders, **(Fig 7)**. Do not fully tighten hardware at this time.

Note: The Sliders are packed with the Step Bars.

Level and adjust the Step Bar and fully tighten all hardware.

Repeat **Steps 1-8** for the other side Step Bar installation. **The installation is completed!!!**

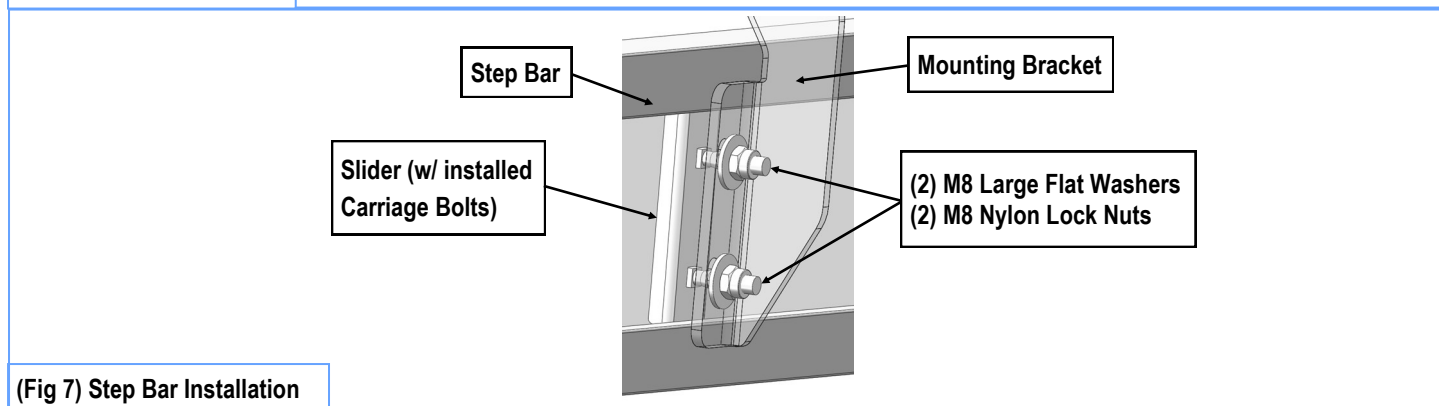
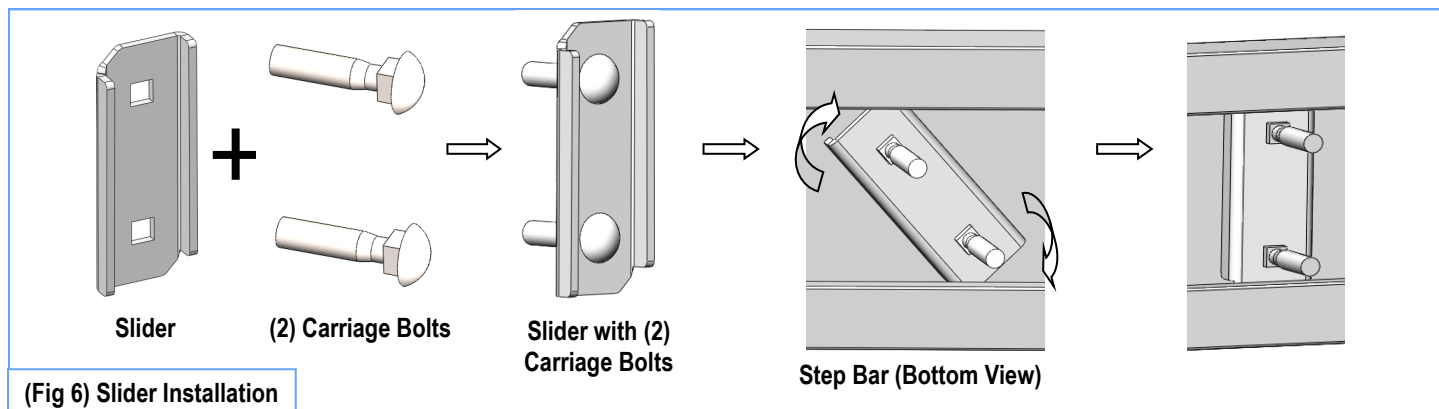

Attention

Do periodic inspections to the installation to make sure that all hardware is secure and tight.
In order to protect your bars/boards, please use mild soap/non-abrasive products for cleaning only.