

iBoard®



Scan for Installation Video

iBoard® by APS

PART#: IB-175C&H

READ INSTRUCTIONS CAREFULLY BEFORE STARTING INSTALLATION. REMOVE CONTENTS FROM BOX AND VERIFY ALL PARTS ARE PRESENT. ASSISTANCE IS RECOMMENDED.

*ROCKER PANEL MOUNT
*NO DRILLING REQUIRED

Fastener Size	Tightening Torque (ft-lbs)	Required
6mm	6-7	X
8mm	16-18	√
10mm	31-32	X
12mm	56-58	X
14mm	92-94	X

PART LIST

Driver Side Step Bar

Front

Passenger Side Step Bar

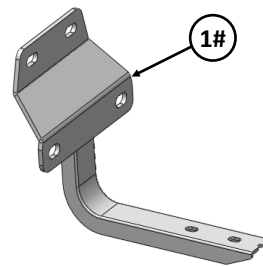
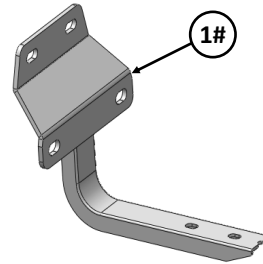
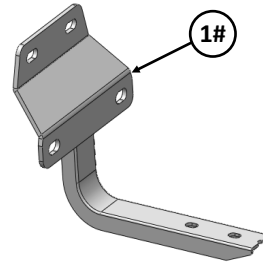
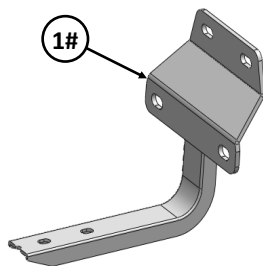
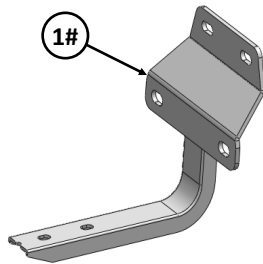
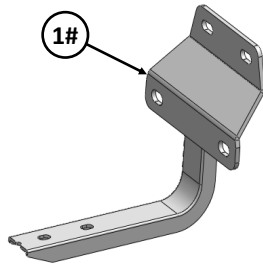
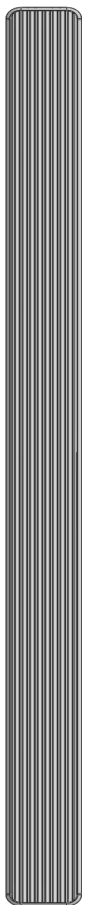

Customer Support: info@iboardauto.com



Mounting Bracket List					
Item	QTY	Description	Item	QTY	Description
1#	6	Mounting Brackets			

Hardware Package A (For Bracket Installation)					
Item	QTY	Description	Item	QTY	Description
1#	18	M8 Plastic Washers	3#	18	M8X1.25 Nylon Lock Nuts
2#	18	M8 Large Flat Washers			



1 #



2 #



3 #

Hardware Package B (For Stainless Steel Step Bar Installation)					
Item	QTY	Description	Item	QTY	Description
1#	12	M8X1.25-35mm Carriage Bolts	3#	12	M8 Nylon Lock Nuts
2#	12	M8 Large Flat Washers	4#	6	Sliders (Packed with Step Bars)

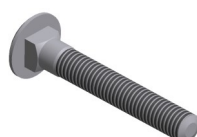

1 #



2 #



3 #

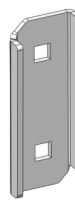

4 #



STEP 1

Start the installation under the passenger side of the vehicle. Locate the front factory running board mounting location along the inner side of the body, **(Fig 1)**.

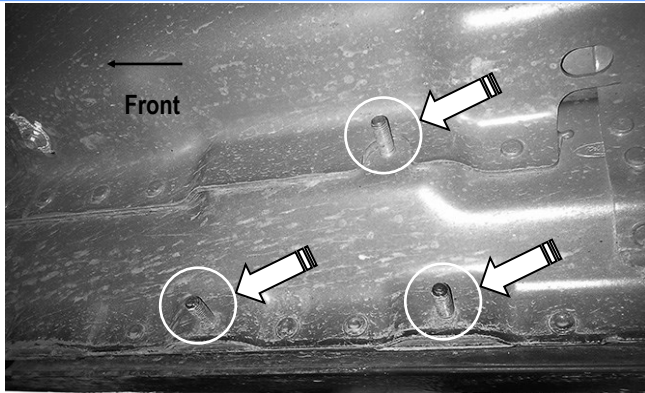

(Fig 1) Passenger Side Front Mounting Location

STEP 2

Slide (1) 8mm Plastic Washer over each factory mounting stud in the body panel, **(Fig 2 & 3)**.

IMPORTANT: M8 Plastic Washers are designed to prevent corrosion between the aluminum body panel and the steel mounting brackets.

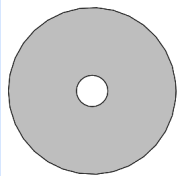

(Fig 2) M8 Plastic Washer

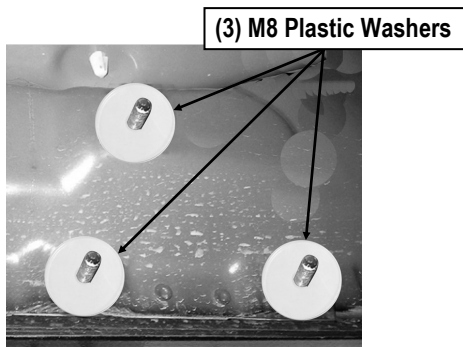

(Fig 3) Thread 8mm Plastic Washers Onto All Mounting Studs.
Passenger Side Rear Mounting Location

STEP 3

Select (1) Mounting Bracket. Attach the Mounting Bracket to the (3) factory studs on Passenger Side Front Mounting Location with (3) M8 Large Flat Washers and (3) M8X1.25 Nylon Lock Nuts, **(Fig 4)**. Snug but do not fully tighten the hardware.

NOTE: All (6) Mounting Brackets are universal.

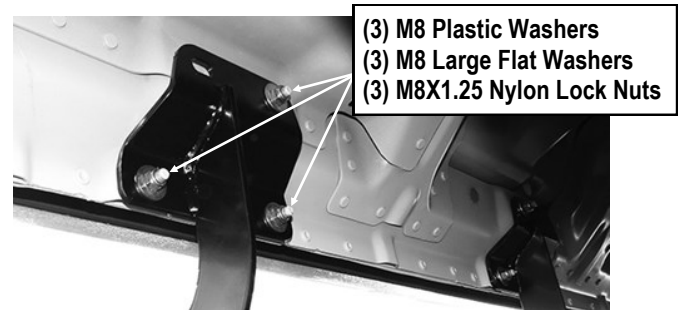

(Fig 4) Passenger Front Mounting Bracket Installed (Example)

STEP 4

Repeat **Steps 1—3** to install the (2) remaining Passenger Center and Rear Mounting Brackets.

STEP 5

Once all (3) Passenger side mounting brackets are installed, then proceed to the Step Bar installation. **(Figs 5 & 6)**

- (1) Select (1) Slider and (2) M8X1.25-35mm Carriage Bolts;
- (2) Install (2) M8X1.25-35mm Carriage Bolts in (1) Slider.
- (3) Slide the Slider (with carriage bolts) to the **Step Bar**.
- (4) Repeat to install the other (2) sliders to the step bar.
- (5) Attach the Step Bar (with the Sliders) onto the installed mounting brackets. Position the Sliders to the installed bracket.



ets. Secure the Step Bar to the installed Brackets by using (6) M8 Large Flat Washers and (6) M8 Nylon Lock Nuts and (3) Sliders, **(Fig 6)**.

Do not fully tighten hardware at this time.

Note: The Sliders are packed with the Step Bars.

Level and adjust the Step Bar and fully tighten all hardware.

Repeat **Steps 1-5** for the other side Step Bar installation. **The installation is completed!!!**

Attention

Do periodic inspections to the installation to make sure that all hardware is secure and tight.

In order to protect your bars/boards, please use mild soap/non-abrasive products for cleaning only.

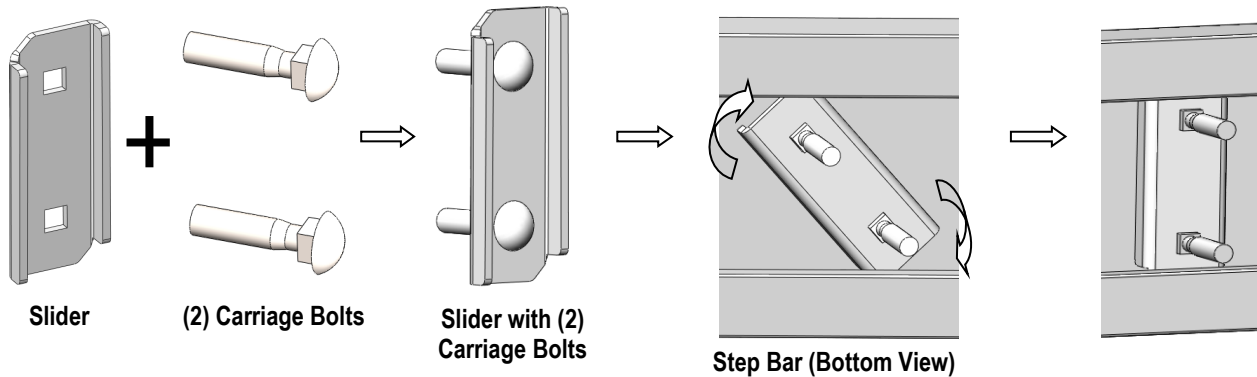

(Fig 5) Slider Installation

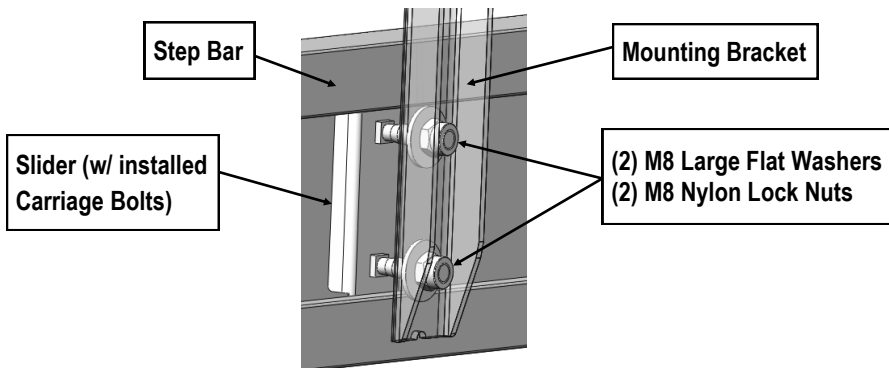

(Fig 6) Step Bar Installation