

iBoard®



Scan for
Installation Video

iBoard® by APS

PART#: IB-134C&H

READ INSTRUCTIONS CAREFULLY BEFORE STARTING INSTALLATION. REMOVE CONTENTS FROM BOX AND VERIFY ALL PARTS ARE PRESENT. ASSISTANCE IS RECOMMENDED.

*ROCKER PANEL MOUNT
*NO DRILLING REQUIRED

Fastener Size	Tightening Torque (ft-lbs)	Required
6mm	6-7	X
8mm	16-18	√
10mm	31-32	X
12mm	56-58	X
14mm	92-94	X

PART LIST

Driver Side Step Bar

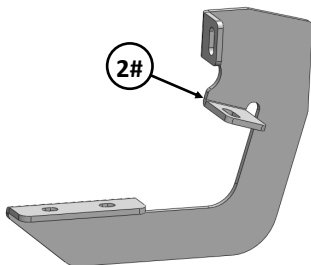
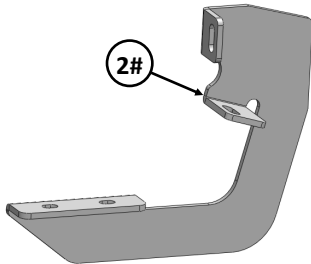
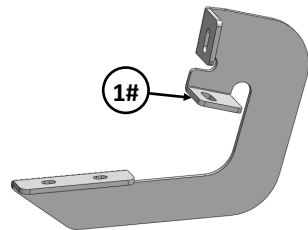
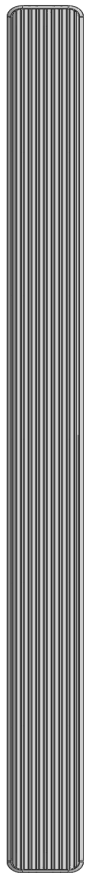

Front



Passenger Side Step Bar

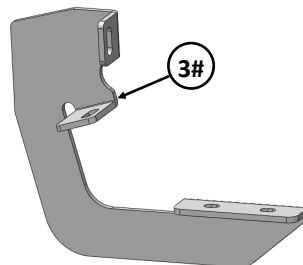
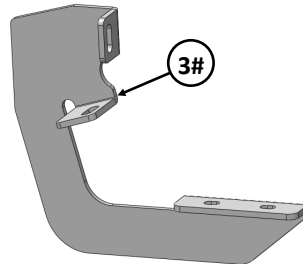
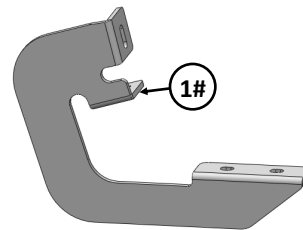
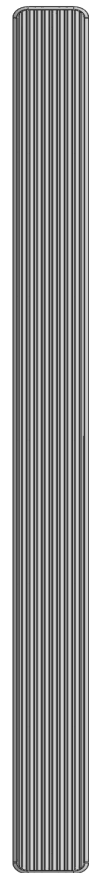

Customer Support: info@iboardauto.com



Mounting Bracket List					
Item	QTY	Description	Item	QTY	Description
1#	2	Driver & Passenger Front Mounting Brackets	3#	2	Passenger Center & Rear Mounting Brackets
2#	2	Driver Center & Rear Mounting Brackets			

Hardware Package A (For Bracket Installation)					
Item	QTY	Description	Item	QTY	Description
1#	12	M8X1.25-25mm Hex Bolts	4#	6	M8 Hex Nuts
2#	18	M8 Large Flat Washers	5#	6	ST8x25mm Hex Self Tapping Screws
3#	12	M8 Lock Washers			



1#



2#



3#



4#

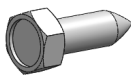

5#

Hardware Package B (For Stainless Steel Step Bar Installation)					
Item	QTY	Description	Item	QTY	Description
1#	12	M8X1.25-35mm Carriage Bolts	3#	12	M8 Nylon Lock Nuts
2#	12	M8 Large Flat Washers	4#	6	Sliders (Packed with Step Bars)

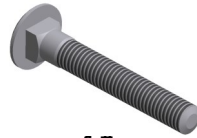

1 #



2 #



3 #

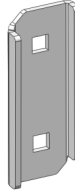

4 #



STEP 1

Start installation from the Passenger Side of the vehicle. Identify the mounting locations along the inner side of the rocker panel, remove any tape on the inside of rocker panel that covers the mounting holes, **(Fig 1)**.

NOTE: (1) ST8x25mm Hex Self Tapping Screws replace (1) M8X1.25-25mm Hex Bolt per bracket if the factory holes are not tapped for 8mm bolts, **(Fig 1)**.

Attach the passenger side mounting brackets to underside of the rocker panel as shown on **Fig 1**. Do not fully tighten hardware at this time.

STEP 2

Once all (3) Passenger side mounting brackets are installed, then proceed to the Step Bar installation. **(Figs 2 & 3)**

- (1) Select (1) Slider and (2) M8X1.25-35mm Carriage Bolts;
- (2) Install (2) M8X1.25-35mm Carriage Bolts in (1) Slider.
- (3) Slide the Slider (with carriage bolts) to the **Step Bar**.
- (4) Repeat to install the other (2) sliders to the step bar.
- (5) Attach the Step Bar (with the Sliders) onto the installed mounting brackets. Position the Sliders to the installed brackets. Secure the Step Bar to the installed Brackets by using (6) M8 Large Flat Washers and (6) M8 Nylon Lock Nuts and (3) Sliders, **(Fig 3)**. Do not fully tighten hardware at this time.

Note: The Sliders are packed with the Step Bars.

Level and adjust the Step Bar and fully tighten all hardware.

Repeat **Steps 1-2** for the other side Step Bar installation. **The installation is completed!!!**

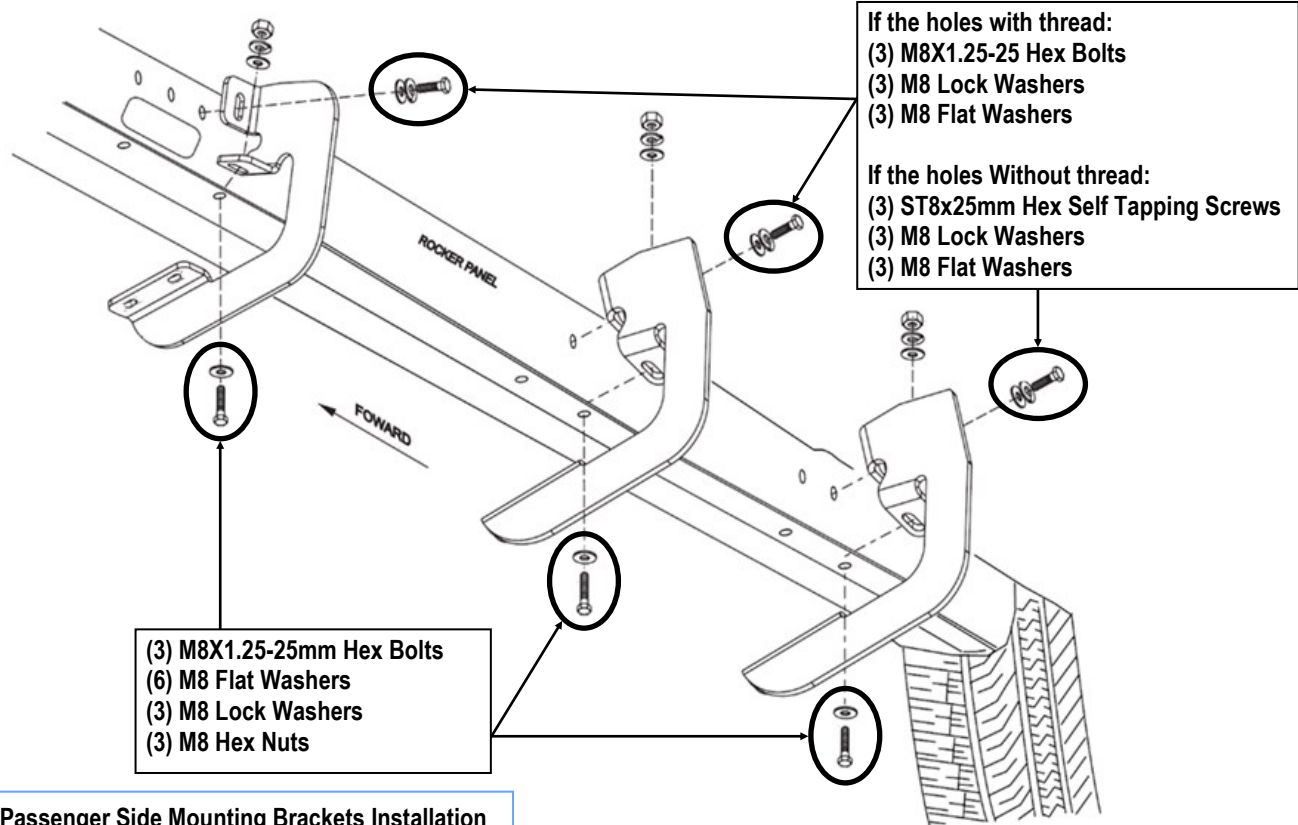

(Fig 1) Passenger Side Mounting Brackets Installation



Scan for
Installation Video

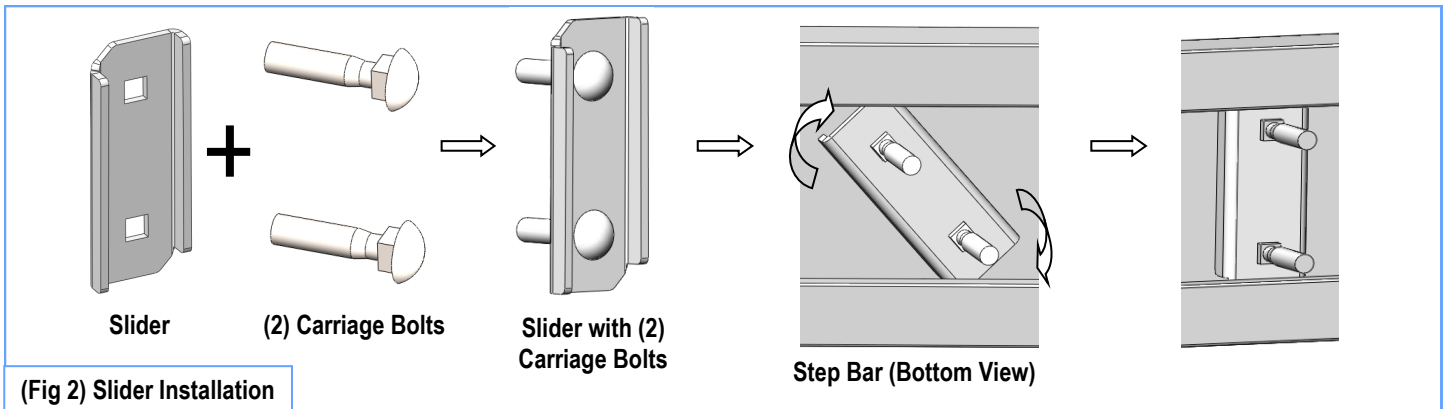

(Fig 2) Slider Installation

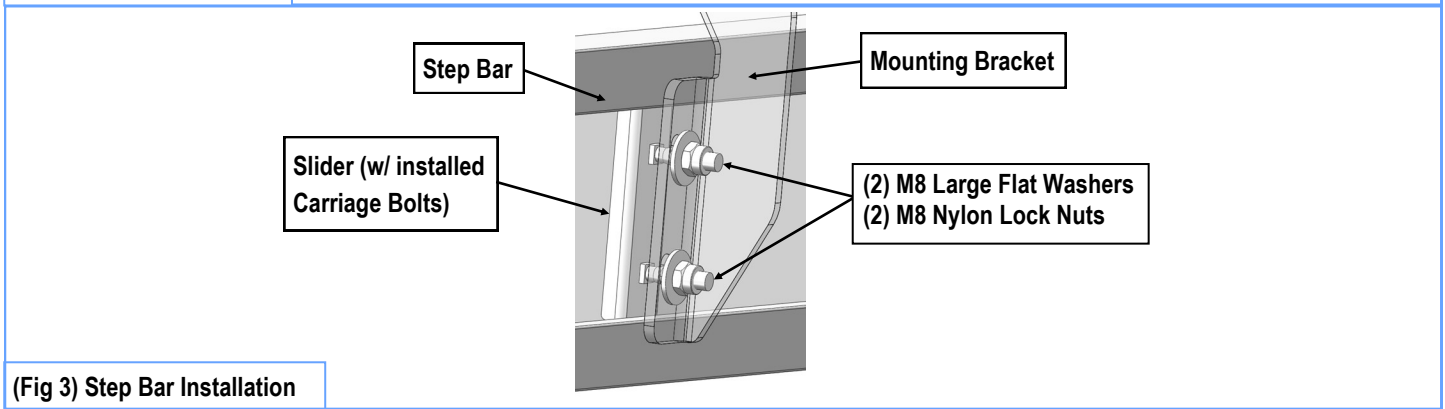

(Fig 3) Step Bar Installation