

# iBoard®



Scan for  
Installation Video

## iBoard® by APS

PART#: IB-009C&H

READ INSTRUCTIONS CAREFULLY BEFORE STARTING INSTALLATION. REMOVE CONTENTS FROM BOX AND VERIFY ALL PARTS ARE PRESENT. ASSISTANCE IS RECOMMENDED.

\*ROCKER PANEL MOUNT  
\*NO DRILLING REQUIRED

Fastener Size	Tightening Torque (ft-lbs)	Required
6mm	6-7	X
8mm	16-18	√
10mm	31-32	X
12mm	56-58	X
14mm	92-94	X

### PART LIST

#### Driver Side Step Bar

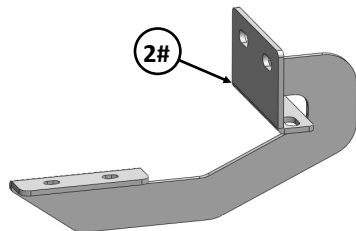
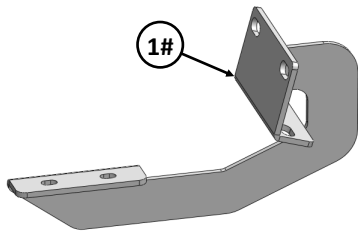
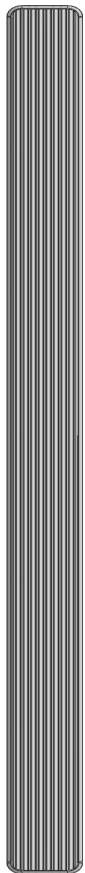

Front



#### Passenger Side Step Bar

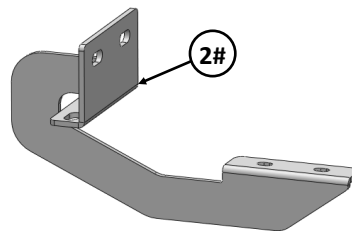
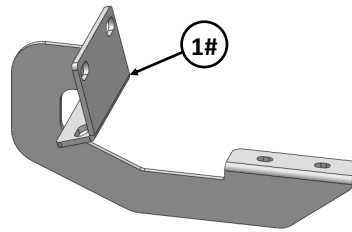
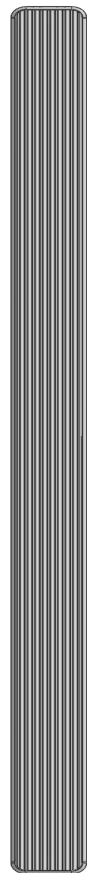

Customer Support: [info@iboardauto.com](mailto:info@iboardauto.com)



Mounting Bracket List					
Item	QTY	Description	Item	QTY	Description
1#	2	Driver / Passenger Front Mounting Brackets	2#	2	Driver / Passenger Rear Mounting Brackets

Hardware Package A (For Bracket Installation)					
Item	QTY	Description	Item	QTY	Description
1#	16	M8X1.25-30mm Hex Bolts	4#	8	M8X1.25 Hex Nuts
2#	24	M8 Flat Washers	5#	8	M8 Clip Nuts
3#	16	M8 Lock Washers			

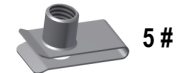
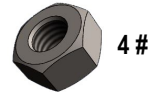

Hardware Package B (For Stainless Steel Step Bar Installation)					
Item	QTY	Description	Item	QTY	Description
1#	8	M8X1.25-35mm Carriage Bolts	3#	8	M8 Nylon Lock Nuts
2#	8	M8 Large Flat Washers	4#	4	Sliders (Packed with Step Bars)

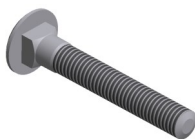

1 #



2 #



3 #



4 #



## STEP 1

Start installation under the Driver Side Front Mounting Location. Remove the large oval rubber cover located on the inner side panel toward the front, **(Fig1)**. Insert (2) M8 Clip Nuts into the round holes **(Fig 2)**. **NOTE:** Threaded nut must go towards the inside of the side panel.



**(Fig 1)** Driver Side Front Mounting Location

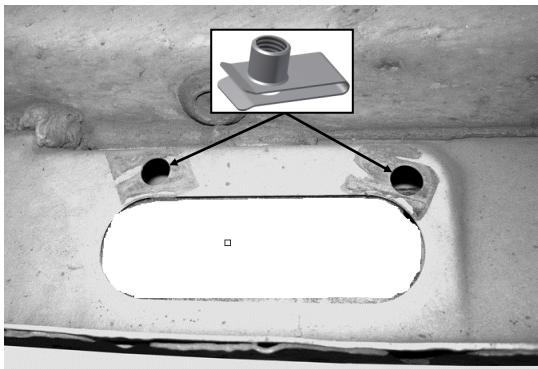

**(Fig 2)** Insert M8 Clip Nut into the Round Hole

## STEP 2

Select (1) Driver Front Mounting Bracket. Attach the Bracket to the installed M8 Clip Nuts with (2) M8X1.25-30mm Hex Bolts, (2) M8 Lock Washers and (2) M8 Large Flat Washers, **(Fig 3)**. Align the bottom holes in the front Bracket with (2) holes in the pinch weld. Bolt the Bracket to the pinch weld using (2) M8X1.25-30mm Hex Bolts, (4) M8 Large Flat Washers, (2) M8X1.25 Lock Washers and (2) M8 Hex Nuts, **(Fig 3)**.

**NOTE:** Insert the bolt up from the bottom of the pinch weld and through the Bracket.

- (2) M8 Clip Nuts
- (2) M8X1.25-30mm Hex Bolts
- (2) M8 Lock Washers
- (2) M8 Large Flat Washers

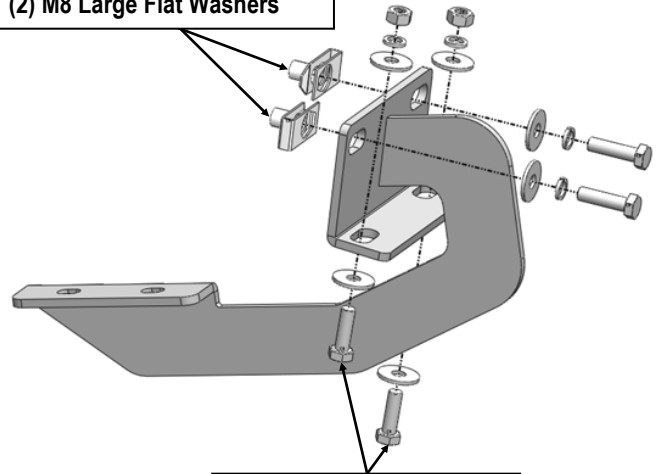

- (1) M8x1.25-25mm Hex Bolt
- (2) M8 Large Flat Washers
- (1) M8 Lock Washer
- (1) M8X1.25 Hex Nut

**(Fig 3)** Driver Front Mounting Bracket Installation

## STEP 3

Next, move along the vehicle to the Driver Side Rear Mounting Location, select a Driver Rear Mounting Bracket, repeat **Steps 1-2** to install the rear bracket. Do not fully tighten hardware at this time.

## STEP 4

Once all (2) driver side mounting brackets are installed, then proceed to the Step Bar installation. **(Figs 4 & 5)**

- (1) Select (1) Slider and (2) M8X1.25-35mm Carriage Bolts;
- (2) Install (2) M8X1.25-35mm Carriage Bolts in (1) Slider.
- (3) Slide the Slider (with carriage bolts) to the **Step Bar**.
- (4) Repeat to install the other (1) slider to the step bar.
- (5) Attach the Step Bar (with the Sliders) onto the installed



mounting brackets. Position the Sliders to the installed brackets. Secure the Step Bar to the installed Brackets by using (4) M8 Large Flat Washers and (4) M8 Nylon Lock Nuts and (2) Sliders, (Fig 5). Do not fully tighten hardware at this time.

**Note:** The Sliders are packed with the Step Bars.

Level and adjust the Step Bar and fully tighten all hardware.

Repeat **Steps 1-4** for the other side Step Bar installation. **The installation is completed!!!**

### Attention

Do periodic inspections to the installation to make sure that all hardware is secure and tight.

In order to protect your bars/boards, please use mild soap/non-abrasive products for cleaning only.

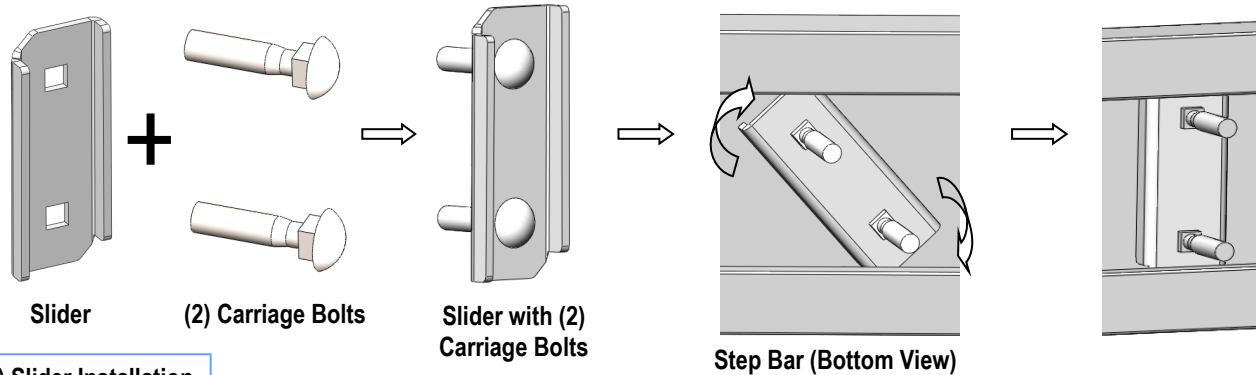

(Fig 4) Slider Installation

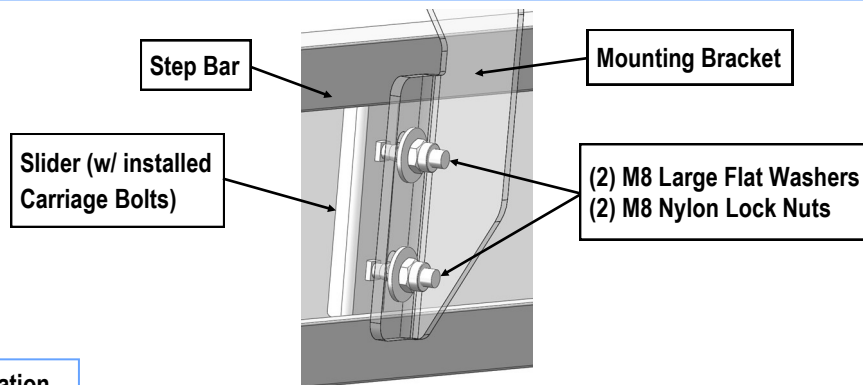

(Fig 5) Step Bar Installation