

iBoard®

iBoard® by APS

PART#: IB-552

READ INSTRUCTIONS CAREFULLY BEFORE STARTING INSTALLATION. REMOVE CONTENTS FROM BOX AND VERIFY ALL PARTS ARE PRESENT. ASSISTANCE IS RECOMMENDED.

*ROCKER PANEL MOUNT
*NO DRILLING REQUIRED

Fastener Size	Tightening Torque (ft-lbs)	Required
6mm	6-7	√
8mm	16-18	√
10mm	31-32	√
12mm	56-58	X
14mm	92-94	X

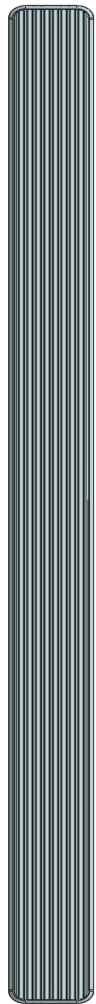

Driver Side Step Bar

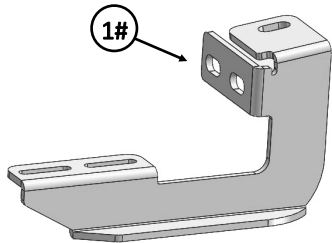
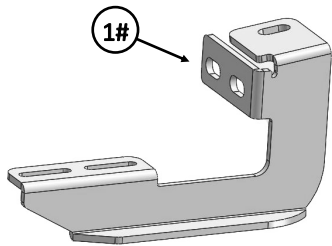
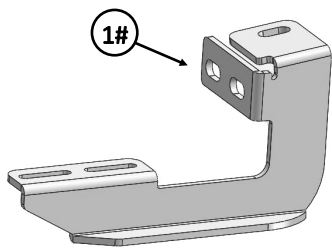

Front
↑

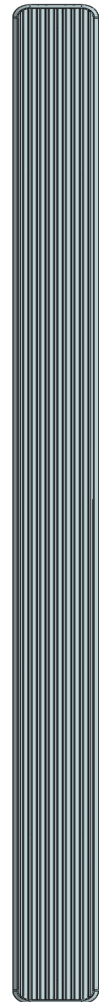
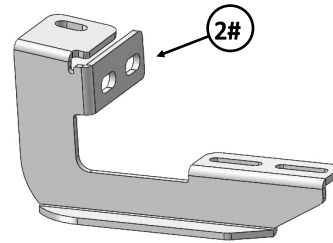
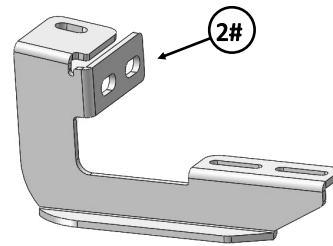
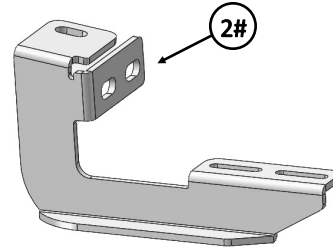



Passenger Side Step Bar

iBoard®

Mounting Bracket List					
Item	QTY	Description	Item	QTY	Description
1#	2	Driver Front / Center / Rear Mounting Brackets	2#	2	Passenger Front / Center / Rear Mounting Brackets

Hardware Package A (For Bracket Installation)					
Item	QTY	Description	Item	QTY	Description
1#	6	M10X1.5-30mm Hex Bolts	5#	12	M8X1.25-25mm Hex Bolts
2#	6	M10 Flat Washers	6#	24	M8 Flat Washers
3#	6	M10 Lock Washers	7#	12	M8 Lock Washers
4#	6	M10 Clip Nuts	8#	12	M8 Hex Nuts

 1#

 2#

 3#

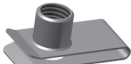
 4#

 5#

 6#

 7#

 8#

Hardware Package B (For Aluminum Step Bar Installation Only, Not Supply to SS. Step Bar)					
Item	QTY	Description	Item	QTY	Description
1#	12	M6X1-20mm Square Head Bolts	3#	12	M6 Nylon Lock Nuts
2#	12	M6 Large Flat Washers			

 1 #

 2 #

 3#

Hardware Package C (For Stainless Steel Step Bar Installation Only, Not Supply to Aluminum Step Bar)					
Item	QTY	Description	Item	QTY	Description
1#	12	M6X1-20mm Hex Bolts	3#	12	M6 Flat Washers
2#	12	M6 Lock Washers			

 1 #

 2 #

 3 #

iBoard®

STEP 1

Start installation from the passenger side front of the vehicle, temporarily remove the plastic side panel. Move to the floor panel, locate the square holes and (2) round holes in the pinch weld, (Fig 1).

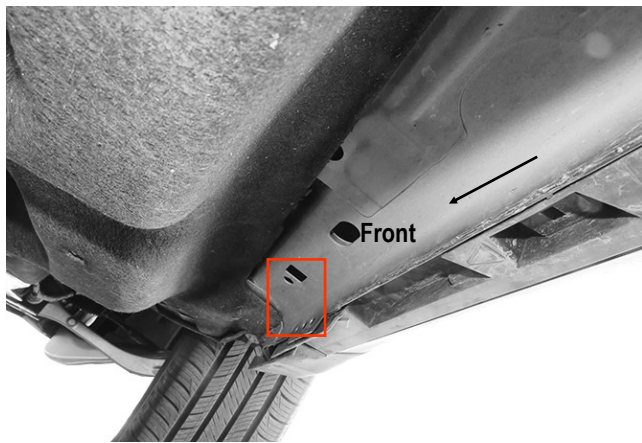

(Fig 1) Passenger Side Front Mounting Location

STEP 2

Select (1) M10 Clip Nut. Attach the M10 Clip Nut into the square hole in the floor panel, (Fig 2).

Select (1) Passenger Front Mounting Bracket. Attach the Bracket to the M10 Clip Nut with (1) M10X1.5-30mm Hex Bolt, (1) M10 Lock Washer and (1) M10 Flat Washer, (Figs 3-4). Do not fully tighten hardware at this time.

STEP 3

Attach the Passenger Front Mounting Bracket to the pinch weld with (2) M8X1.25-25mm Hex Bolts, (4) M8 Flat Washers, (2) M8 Lock Washers and (2) M8 Hex Bolts, (Figs 3-4). Do not fully tighten hardware at this time.

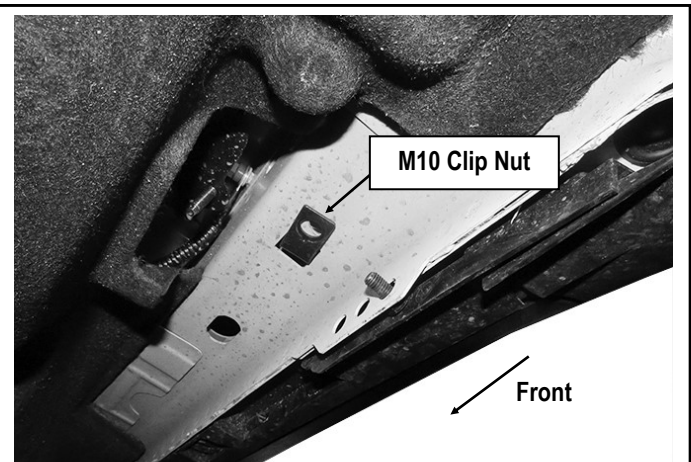

(Fig 2) Attach The M10 Clip Nut

- (2) M8X1.25-25mm Hex Bolts
- (4) M8 Flat Washers
- (2) M8 Lock Washers
- (2) M8 Hex Nuts

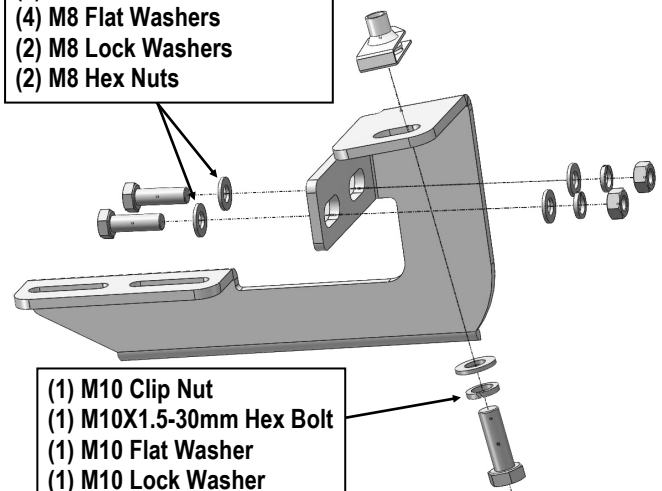

(Fig 3) Passenger Front Mounting Bracket Installation

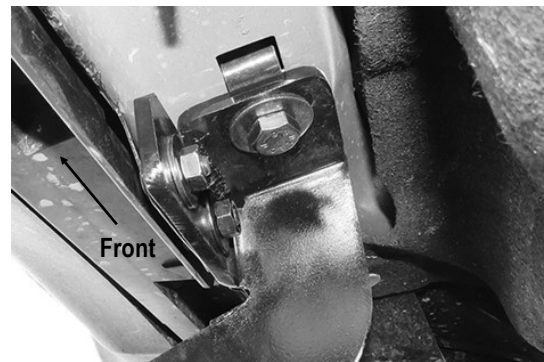

(Fig 4) Passenger Front Mounting Bracket Installation

iBoard®

STEP 4

Move to the center & rear mounting location, (Figs 5 & 6). Repeat **Steps 1-3** to attach the Passenger Center & Rear Mounting Bracket to the vehicle. Do not fully tighten hardware at this time.

Note: Passenger Front & Center & Rear Mounting Brackets are universal.



(Fig 5) Passenger Side Center Mounting Location

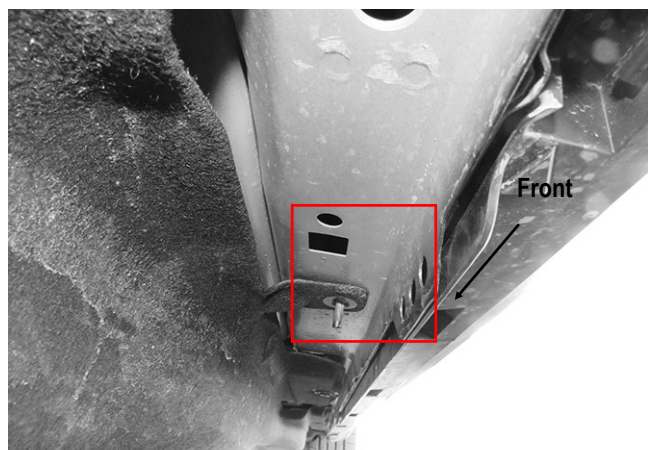

(Fig 6) Passenger Side Rear Mounting Location

STEP 5

Once all (3) mounting brackets are installed, then proceed to the Step Bar installation. According to the style of Step Bar proceed to the correct installation STEPS.

Note: Aluminum Step Bar refer to STEP 6; Stainless Steel Step Bar skip to STEP 7.

STEP 6

Aluminum Step Bar Installation:

Select a **Aluminum Step Bar**. Slip (3) M6x1-20mm Square Head Bolts into each bottom channel (Fig 7). Carefully position the Step Bar onto the (3) Mounting Brackets.

IMPORTANT: Do not slide the Step Bar on the Brackets or the bottom surface of the board will be damaged. Attach the Step Bar to each Mounting Brackets with (2) M6x1-20mm Square Head Bolts, (2) M6 Large Flat Washers and (2) M6 Nylon Lock Nuts, (Fig 8). Do not fully tighten at this time.

Level and adjust the Step Bar and fully tighten all hardware. Repeat **Steps 1-6** for the other side Step Bar installation. **The installation is completed!!!**



(Fig 7) Slip M6X1-20mm Square Head Bolts Into The Bottom Channels

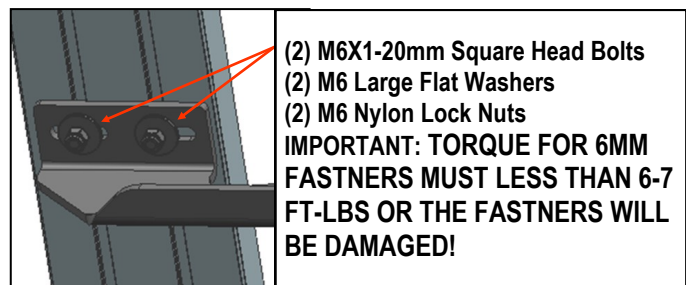

(2) M6X1-20mm Square Head Bolts
(2) M6 Large Flat Washers
(2) M6 Nylon Lock Nuts
IMPORTANT: TORQUE FOR 6MM FASTNERS MUST LESS THAN 6-7 FT-LBS OR THE FASTNERS WILL BE DAMAGED!

(Fig 8) Step Bar Installed Onto Mounting Bracket

iBoard®

STEP 7

Stainless Steel Step Bar Installation:

Select a **Stainless Steel Step Bar** (with the U-Sliders installed on the Bar). Loose the U-Sliders, reposition the U-Sliders onto the board according to the (3) Installed Mounting Brackets location, (Fig 9). Re-secure the U-Sliders on the Step Bar. Attach the Step Bar to the installed Mounting Brackets with (6) M6X1-20mm Hex Bolts, (6) M6 Large Flat Washers & (6) M6 Lock Washers, (Fig 10). Do not fully tighten hardware at this time. Level and adjust the Step Bar and fully tighten all hardware. Repeat **Steps 1-5 and 7** for the other side Step Bar installation. **The installation is completed!!!**



(Fig 9) Slide & line up the U-Slider with the installed mounting brackets along bottom channel

(2) M6X1-20mm Hex Bolts
(2) M6 Large Flat Washers
(2) M6 Lock Washers
IMPORTANT: TORQUE FOR 6MM FASTNERS MUST LESS THAN 6-7 FT-LBS OR THE FASTNERS WILL BE DAMAGED!

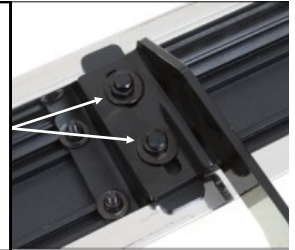

(Fig 10) Step Bar Installed on Bracket Installed

Attention

Do periodic inspections to the installation to make sure that all hardware is secure and tight.
In order to protect your bars/boards, please use only mild soap/non-abrasive products for cleaning.