

iBoard®

iBoard® by APS

PART#: IB-177

READ INSTRUCTIONS CAREFULLY BEFORE STARTING INSTALLATION. REMOVE CONTENTS FROM BOX AND VERIFY ALL PARTS ARE PRESENT. ASSISTANCE IS RECOMMENDED.

*ROCKER PANEL MOUNT
*No DRILLING REQUIRED

Fastener Size	Tightening Torque (ft-lbs)	Required
6mm	6-7	√
8mm	16-18	√
10mm	31-32	X
12mm	56-58	X
14mm	92-94	X

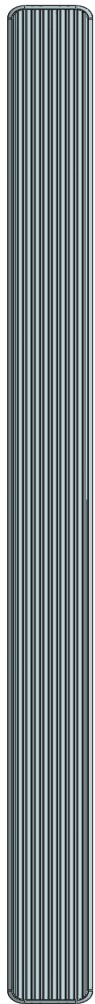

Driver Side Step Bar

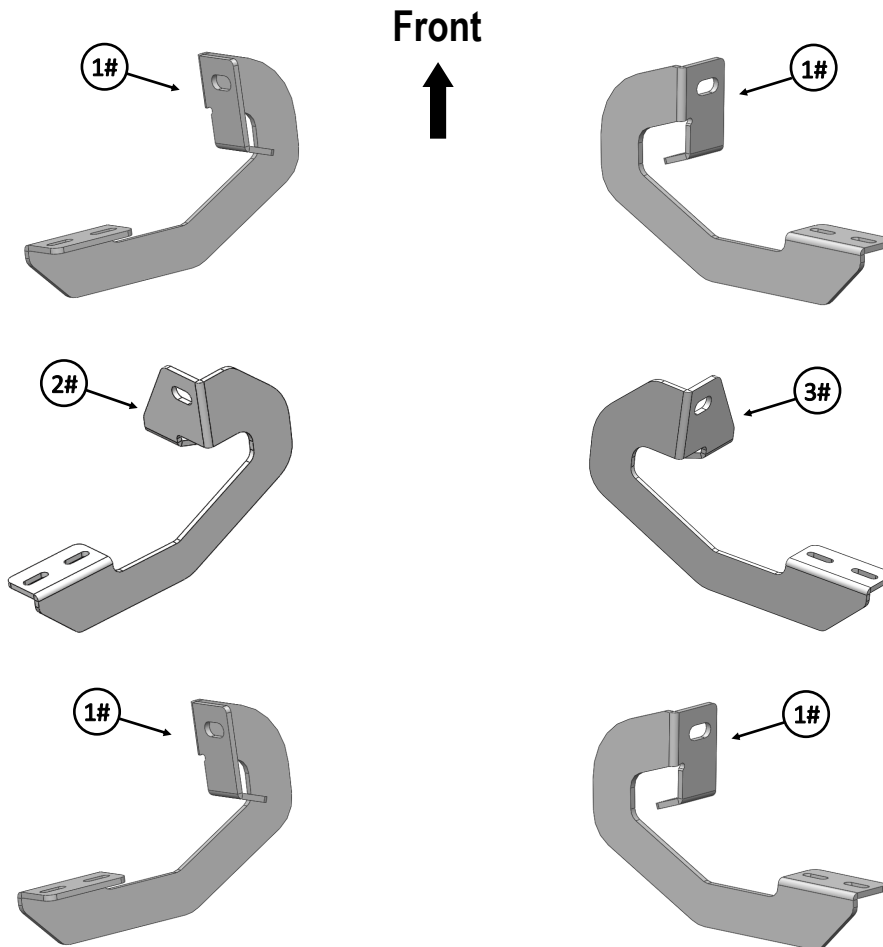







Passenger Side Step Bar



iBoard®

Mounting Bracket List					
Item	QTY	Description	Item	QTY	Description
1#	4	Mounting Brackets	3#	1	Passenger Center Mounting Bracket
2#	1	Driver Center Mounting Bracket			

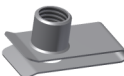

Hardware Package A (For Bracket Installation)					
Item	QTY	Description	Item	QTY	Description
1#	6	M8X1.25 - 30mm Hex Bolts	5#	12	M8 Lock Washers
2#	6	M8x1.25 - 25mm Hex Bolts	6#	6	M8 Hex Nuts
3#	12	M8 Flat Washers	7#	6	M8 Clip Nuts
4#	6	M8 Large Flat Washers			

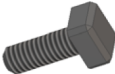
 1 #
 2 #
 3 #
 4 #
 5 #
 6 #
 7 #

Hardware Package B (For Aluminum Step Bar Installation Only, Not Supply to SS. Step Bar)					
Item	QTY	Description	Item	QTY	Description
1#	12	M6X1-20mm Square Head Bolts	3#	12	M6X1 Nylon Lock Nuts
2#	12	M6 Large Flat Washers			

 1 #
 2 #
 3 #

Hardware Package C (For Stainless Steel Step Bar Installation Only, Not Supply to Aluminum Step Bar)					
Item	QTY	Description	Item	QTY	Description
1#	12	M6X1-20mm Hex Bolts	3#	12	M6 Flat Washers
2#	12	M6 Lock Washers			

 1 #
 2 #
 3 #

iBoard®

STEP 1

Starting on the driver side of the vehicle, locate the (2) holes in the bottom of the body panel, (pinch weld), toward the front tire, (Fig 1). Next locate the rectangular opening and (2) small holes in the inner body panel directly above the holes in the pinch weld, (Fig 1 & 2). **NOTE:** The holes in the inner panel may be covered with sealing tape or insulation.

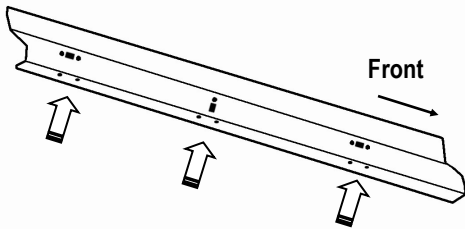

(Fig 1) Driver Inner Body Panel Illustrated
(Locate Holes Through Pinch Weld Arrows To Determine Mounting Locations)

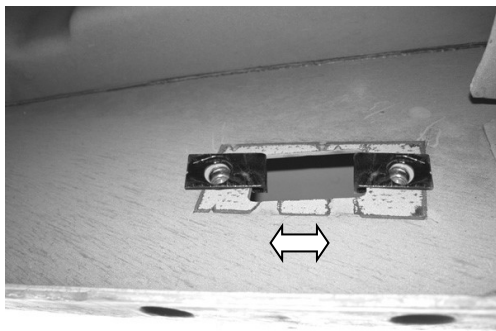

(Fig 2) Slide M8 Clip Nuts Over Holes

STEP 2

Slide (1) M8 Clip Nut into the rectangular opening with the nut towards the inside. Line up the threaded nut on the clip with the round hole, (Fig 2). Repeat to install the 2nd M8 Clip Nut in remaining hole location.

STEP 3

Select (1) Driver Front Mounting Bracket. **NOTE: All (4) Front & Rear Mounting Brackets are universal and will fit driver or passenger side.** Attach the Bracket to the (1) M8 Clip Nuts with the included (1) M8X1.25-30mm Hex Bolt, (1) M8 Lock Washer and (1) M8 Large Flat Washer, (Fig 3). Depending on model and year, the brake cable may be run on the inside or outside of the Bracket. Do not tighten hardware at this time. **NOTE:** The cradle on the front Bracket should face to the rear of the vehicle.

(1) M8X1.25-30mm Hex Bolt
(1) M8 Lock Washer
(1) M8 Large Flat Washer

(1) M8x1.25-25mm Hex Bolt
(2) M8 Flat Washers
(1) M8 Lock Washer
(1) M8 Hex Nut

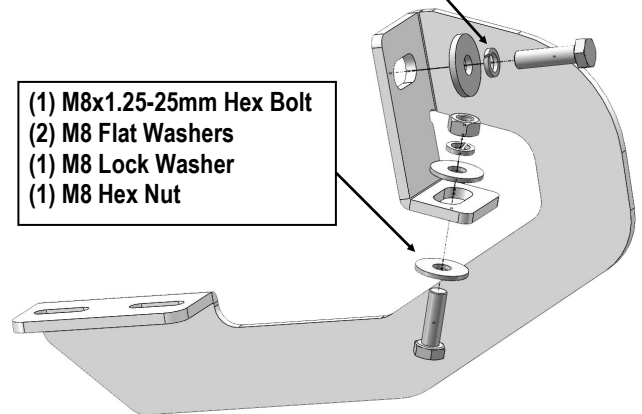

(Fig 3) Driver Front Mounting Bracket Installed

STEP 4

Align the bottom holes in the front Bracket with the (1) holes in the pinch weld. Bolt the Bracket to the pinch weld using the included (1) M8X1.25-25mm Hex Bolt, (2) M8 Flat Washers, (1) M8 Lock Washer and (1) M8 Hex Nut, (Fig 3). **NOTE:** Insert the bolts up from the bottom of the pinch weld and through the Bracket.

iBoard®

STEP 5

Next, move toward the center of the vehicle. Locate the (2) holes in the pinch weld similar to the front location, Insert (1) M8 Clip Nut into the rectangular opening and up to the single small round hole in the body panel, **(Fig 4)**.

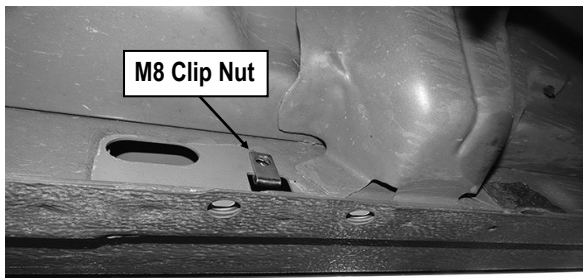

(Fig 4) Driver Center Mounting Bracket Location Pictured

STEP 6

Select Driver Center Mounting Bracket. Attach the Bracket to the M8 Clip Nut with (1) M8X1.25-30mm Hex Bolt, (1) M8 Lock Washer and (1) M8 Large Flat Washer, **(Fig 5)**. Line up the hole in the Bracket with the hole in the pinch weld. Bolt the Bracket to the pinch weld with (1) M8x1.25-25mm Hex Bolt, (2) M8 Flat Washers, (1) M8 Lock Washer and (1) M8 Hex Nut. Do not tighten hardware at this time. **NOTE:** The cradle on the center mounting Bracket will face the front of the vehicle.

STEP 7

Continue along the cab to the rear mounting location. Repeat **Steps 1—4** for Driver Rear Mounting Bracket installation. **NOTE:** The cradle on the rear Bracket should face the front of the vehicle.

(1) M8X1.25-30mm Hex Bolts
(1) M8 Lock Washers
(1) M8 Large Flat Washers

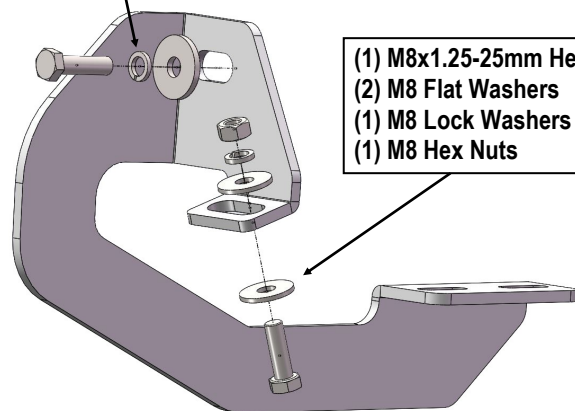

(1) M8x1.25-25mm Hex Bolts
(2) M8 Flat Washers
(1) M8 Lock Washers
(1) M8 Hex Nuts

(Fig 5) Driver Center Mounting Bracket Installed

STEP 8

Once all (3) mounting brackets are installed, then proceed to the Step Bar installation. According to the style of Step Bar proceed to the correct installation STEPS.

Note: Aluminum Step Bar refer to 9; Stainless Steel Step Bar skip to STEP 10.

STEP 9

Aluminum Step Bar Installation:

Select a **Aluminum Step Bar**. Slip (3) M6x1-20mm Square Head Bolts into each bottom channel **(Fig 6)**. Carefully position the Step Bar onto the (3) Mounting Brackets.

IMPORTANT: Do not slide the Step Bar on the Brackets or the bottom surface of the board will be damaged. Attach the Step Bar to each Mounting Brackets with (2) M6x1-20mm Square Head Bolts, (2) M6 Large Flat Washers and (2) M6X1 Nylon Lock Nuts, **(Fig 7)**. Do not fully tighten at this time.

Level and adjust the Step Bar and fully tighten all hardware.

Repeat **Steps 1-9** for the other side Step Bar installation. **The installation is completed!!!**

iBoard®

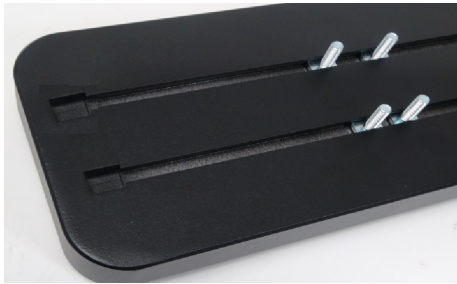

(Fig 6) Slip M6X1-20mm Square Head Bolts Into The Bottom Channels

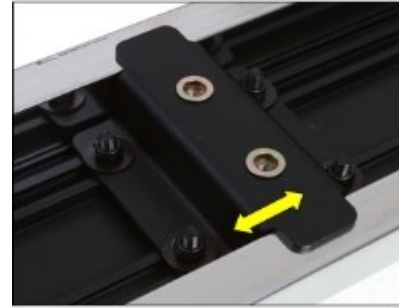

(Fig 8) Slide & line up the U-Slider with the installed mounting brackets along bottom channel

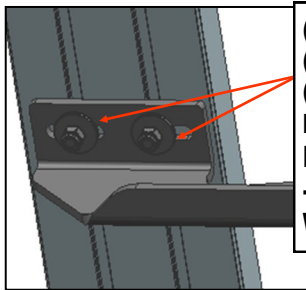

(2) M6X1-20 Square Head Bolts
(2) M6 Large Flat Washers
(2) M6 Nylon Lock Nuts
IMPORTANT: TORQUE FOR 6MM FASTNERS MUST LESS THAN 6-7 FT-LBS OR THE FASTNERS WILL BE DAMAGED!

(Fig 7) Running Board Installed Onto Mounting Bracket

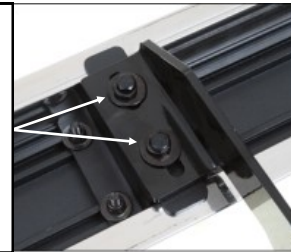

(2) M6X1-20mm Hex Bolts
(2) M6 Large Flat Washers
(2) M6 Lock Washers
IMPORTANT: TORQUE FOR 6MM FASTNERS MUST LESS THAN 6-7 FT-LBS OR THE FASTNERS WILL BE DAMAGED!

(Fig 9) Step Bar Installed on Bracket Installed (Example)

STEP 10

Stainless Steel Step Bar Installation:

Select a **Stainless Steel Step Bar** (with the U-Sliders installed on the Bar). Loose the U-Sliders, reposition the U-Sliders onto the board according to the (3) Installed Mounting Brackets location, (Fig 8). Re-secure the U-Sliders on the Step Bar. Attach the Step Bar to the installed Mounting Brackets with (6) M6X1-20mm Hex Bolts, (6) M6 Large Flat Washers & (6) M6 Lock Washers, (Fig 9). Do not fully tighten hardware at this time.

Level and adjust the Step Bar and fully tighten all hardware. Repeat **Steps 1-8 and 10** for the other side Step Bar installation. **The installation is completed!!!**

Attention

Do periodic inspections to the installation to make sure that all hardware is secure and tight.
In order to protect your bars/boards, please use only mild soap/non-abrasive products for cleaning.