

iBoard®



Scan for
Installation Video

iBoard® by APS

PART#: IB-209[L,S]C&H

READ INSTRUCTIONS CAREFULLY BEFORE STARTING INSTALLATION. REMOVE CONTENTS FROM BOX AND VERIFY ALL PARTS ARE PRESENT. ASSISTANCE IS RECOMMENDED.

*ROCKER PANEL MOUNT
*DRILLING MAY BE REQUIRED

Fastener Size	Tightening Torque (ft-lbs)	Required
6mm	6-7	√
8mm	16-18	√
10mm	31-32	√
12mm	56-58	X
14mm	92-94	X

PART LIST

Driver Side Step Bar

Front
↑

Passenger Side Step Bar

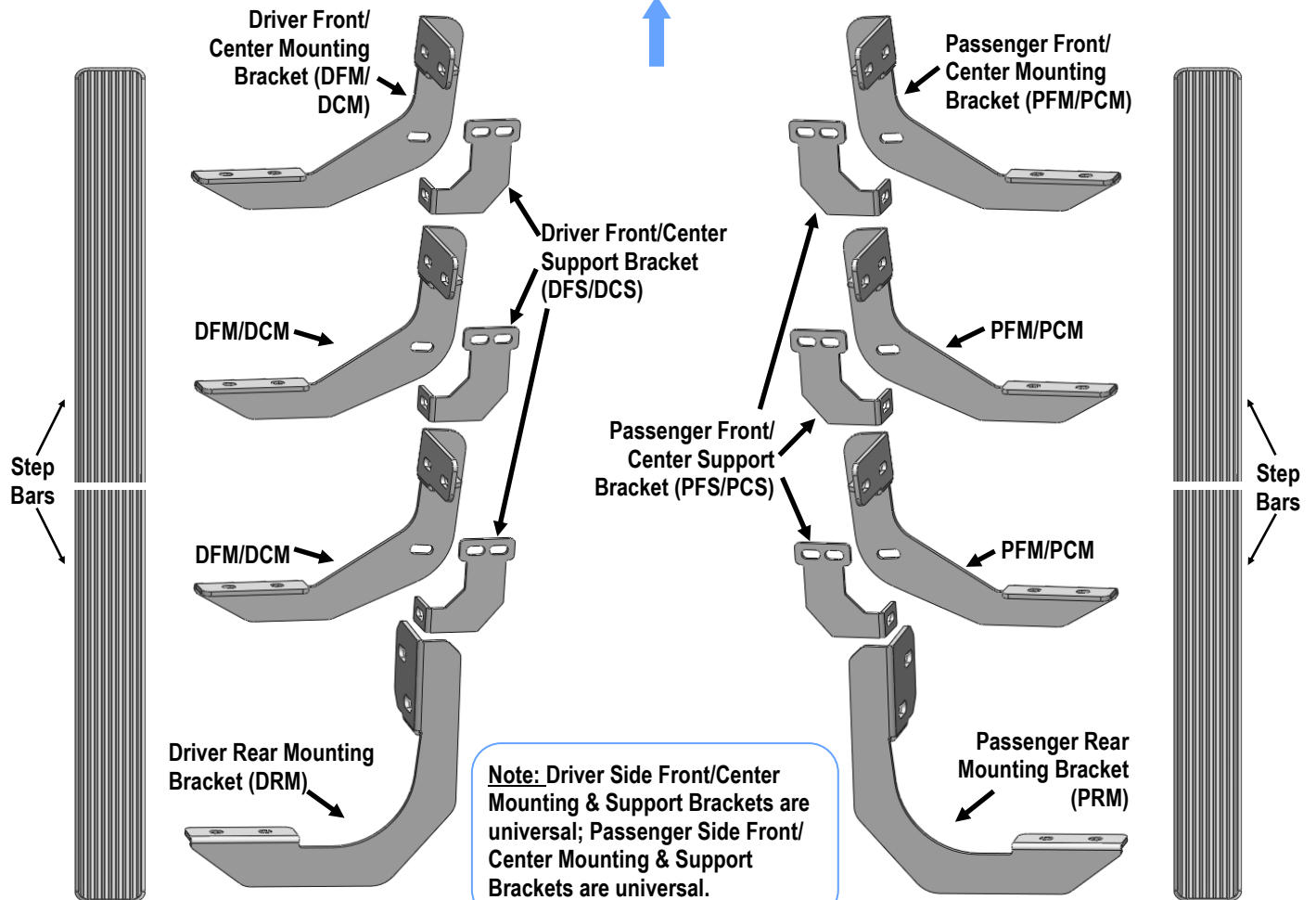

Customer Support: info@iboardauto.com



Hardware Package A (For Bracket Installation)

Item	QTY	Description	Item	QTY	Description
1#	6	M8 Bolt/Nut Plates	9#	18	M8X1.25-30mm Hex Bolts
2#	2	M10 Bolt/Nut Plates	10#	24	M8 Large Flat Washers
3#	6	M8 Plastic Washers	11#	12	M8 Lock Washers
4#	2	M10 Plastic Washers	12#	6	M8 Hex Nuts
5#	2	M10X1.5-30mm Hex Bolts	13#	6	M8 Nylon Lock Nuts
6#	4	M10 Flat Washers	14#	12	M6X1-25mm Hex Bolts
7#	4	M10 Lock Washers	15#	24	M6 Large Flat Washers
8#	2	M10 Hex Nuts	16#	12	M6 Nylon Lock Nuts

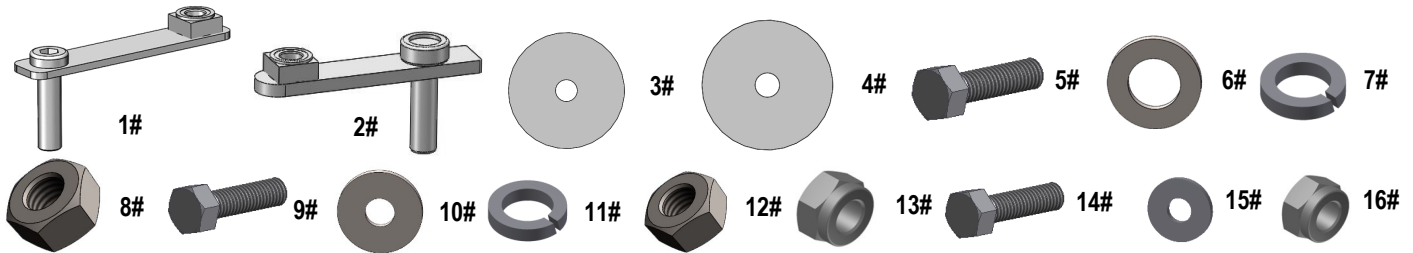

Hardware Package B (For Stainless Steel Step Bar Installation)

Item	QTY	Description	Item	QTY	Description
1#	16	M8X1.25-35mm Carriage Bolts	3#	16	M8 Nylon Lock Nuts
2#	16	M8 Large Flat Washers	4#	8	Sliders (Packed with Step Bars)



Hardware Package C (For Stainless Steel Step Bar Assembly)

Item	QTY	Description	Item	QTY	Description
1#	8	Plastic Rivets	5#	4	M8 Hex Nuts
2#	12	M8X1.25-25mm Inner Hex Bolts	6#	2	Plastic Covers (Packed with Step Bars)
3#	16	M8 Flat Washers	7#	2	Back Plates (Packed with Step Bars)
4#	12	M8 Lock Washers			





STEP 1

Step Bar Assembly:

1. Select and assemble (2) Step Bars with (2) M8X1.25-25mm Inner Hex Bolts, (4) M8 Flat Washers, (2) M8 Lock Washers and (2) M8 Hex Nuts, (**Fig 1**). **NOTE: (4) Step Bars are universal.**
2. Attach (1) Back Plate to the bottom of the installed (2) Step Bars with (4) M8X1.25-25mm Inner Hex Bolts, (4) M8 Flat Washers, (4) M8 Lock Washers, (**Fig 2**).
3. Install (1) Plastic Cover to cover the joint of (2) Step bars with (4) Plastic Rivets, (**Fig 3**).
4. Repeat to assemble the other (2) Step Bars.

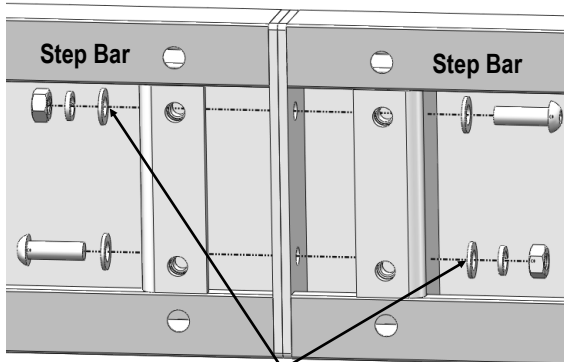

(2) M8X1.25-25mm Inner Hex Bolts
(4) M8 Flat Washers
(2) M8 Lock Washers
(2) M8 Hex Nuts

(Fig 1) Step Bars Assembly

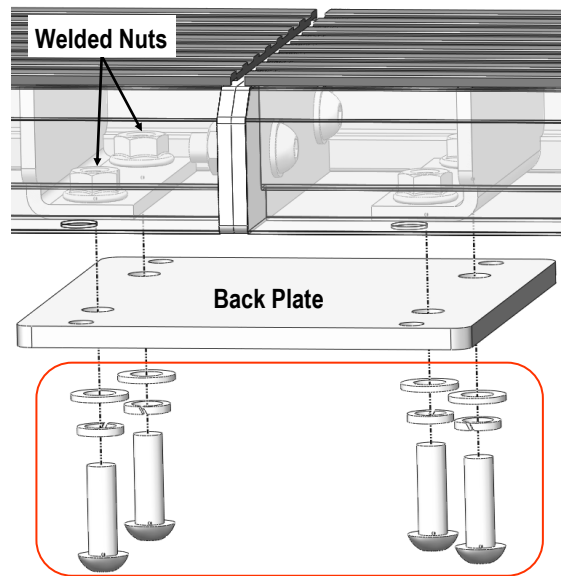

(4) M8X1.25-25mm Inner Hex Bolts
(4) M8 Flat Washers
(4) M8 Lock Washers

(Fig 2) Back Plate Installation

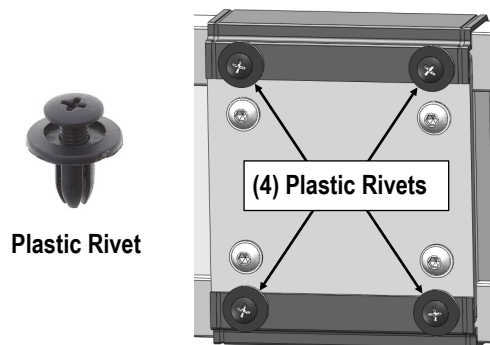

Plastic Rivet

(Fig 3) Plastic Cover Installation
(Bottom View)

Assembled Step Bars





STEP 2

Start installation on the driver side of the vehicle, remove the sealing tapes covering the factory oval holes on the inner side of the body panel, (Fig 4A & 4B & 4C).

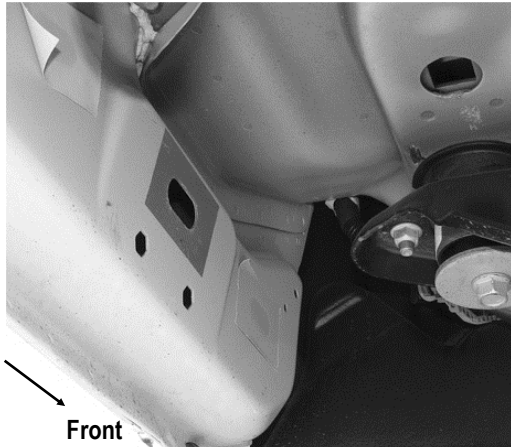

(Fig 4A) Driver Side Front Mounting Location

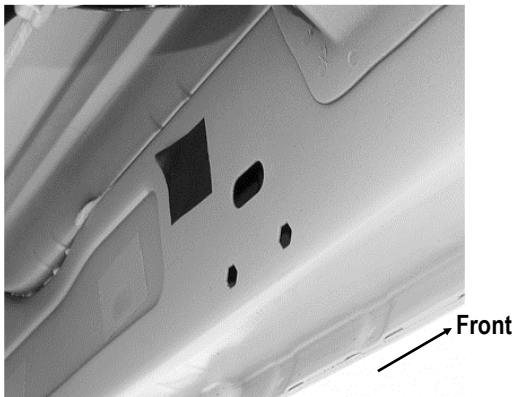

(Fig 4B) Driver Side 2nd Mounting Location

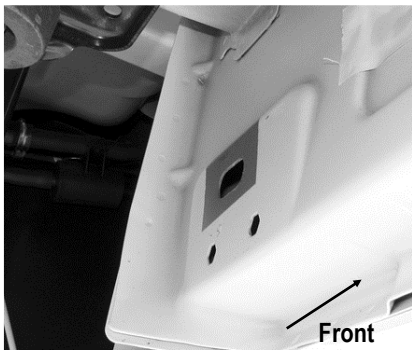

(Fig 4C) Driver Side 3rd Mounting Location

STEP 3

Determine the correct procedure to attach (1) Driver Front Mounting Bracket (DFM/DCM) for your model/year:

Models without factory threaded inserts in body panel:

a. Partially thread (1) M8X1.25-30mm Hex Bolt into the threaded end of an M8 Bolt/Nut Plate, (Fig 5). Thread the hex bolt in until it is flush with the welded nut, (Fig 6). Use the hex bolt as a handle and insert the Bolt/Nut Plate into the oval hole, (Fig 7). Feed the threaded bolt on the plate through one of the hex shaped factory holes. Thread (1) M8 Plastic Washer onto the threaded end and down tight against the body panel, (Fig 8).

NOTE: The Plastic washer is designed to keep the M8 Bolt/ Nut Plate from falling into the body panel and to aid in bracket installation.

b. Attach (1) Driver Front Mounting Bracket to the threaded end of the M8 Bolt/Nut Plate on the driver side front location with (1) M8 Large Flat Washer, (1) M8 Lock Washer and (1) M8 Hex Nut, (Fig 9). Remove the M8X1.25-30mm Hex Bolt from the nut on the M8 Bolt/Nut Plate. Rotate the Bolt on the Bolt Plate until the threaded nut lines up with the remaining hole in the Mounting Bracket and body panel. Do not fully tighten hardware at this time.

c. Attach the Driver Front Mounting Bracket to the threaded nut on the M8 Bolt/Nut Plate with (1) M8x1.25-30mm Hex Bolt, (1) M8 Lock Washer and (1) M8 Large Flat Washer, (Fig 9). Do not fully tighten hardware at this time.



(Fig 5) M8 Bolt/Nut Plate (NOTE: M8 Bolt/Nut Plate is not required on models with threaded inserts)

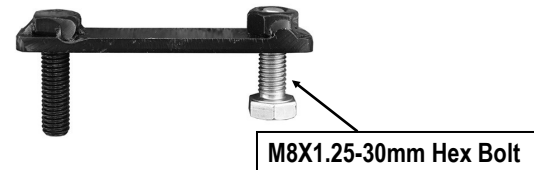

(Fig 6) Thread (1) M8X1.25-30mm Hex Bolt into the nut on the plate. (Stop when bolt reaches end of nut as pictured)

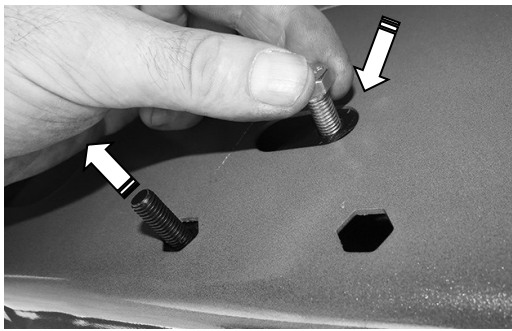

(Fig 7) Use the loose Hex Bolt as a handle. Insert the Bolt Plate into the oval hole and feed the threaded end out either factory hex shaped hole. **IMPORTANT:** Do not let go of the hex bolt until after Plastic Washer has been threaded onto bolt (Fig 5).

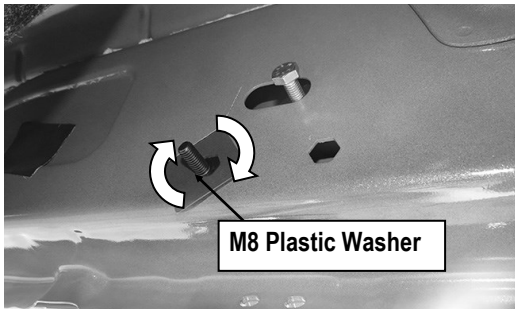

(Fig 8) Thread Plastic Washer onto Bolt Plate to hold Bolt Plate in position

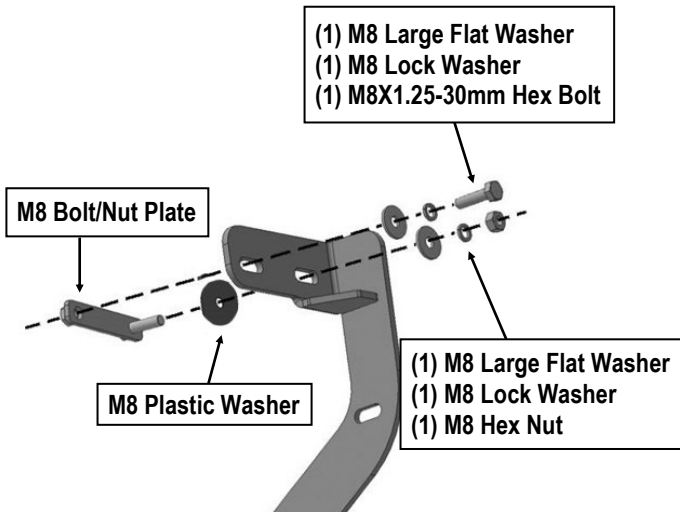

(Fig 9) Driver Front Mounting Bracket Installation

STEP 4

Models with factory threaded inserts:

Attach Driver Front Mounting Bracket to the threaded inserts with (2) M8x1.25-30mm Hex Bolts, (2) M8 Lock Washers and (2) M8 Large Flat Washers, (Figs 10 & 11). Do not fully tighten hardware at this time.

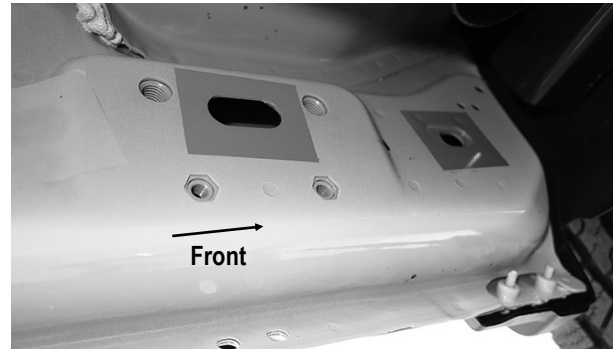

(Fig 10) Driver Side Front Mounting Location mid 15-on (Example of models with factory installed threaded inserts)

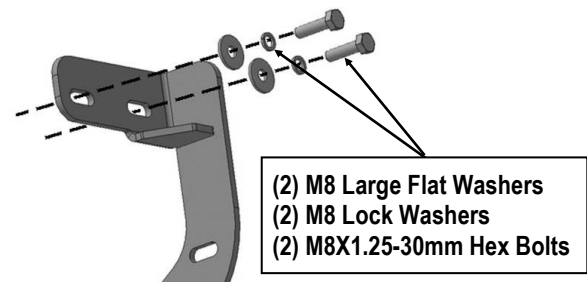

(Fig 11) Driver Front Mounting Bracket Installation

STEP 5

Attach the Driver Front Support Bracket (DFS/DCS) to the back side of the Front Mounting Bracket (DFM/DCM) with (1) M8X1.25-30mm Hex Bolt, (2) M8 Large Flat Washers and (1) M8 Nylon Lock Nut, (Fig 12).

Rotate the Support Bracket to the back of the pinch weld. Attach the Support Bracket to the pinch weld with (2) M6X1-25mm Hex Bolts, (4) M6 Large Flat Washers, (2) M6 Nylon Lock Nuts. (Figs 13 & 14). Do not Fully tighten at this time.

Important: Some models are not equipped with factory holes



and **will require drilling** through the pinch weld to attach the Support Bracket. Do not drill through pinch weld at this time. (Refer to Step 10).

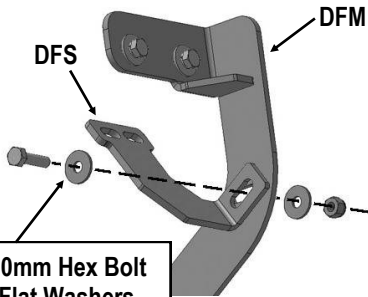

- (1) M8x1.25-30mm Hex Bolt
- (2) M8 Large Flat Washers
- (1) M8 Nylon Lock Nut

(Fig 12) Driver Side Front Brackets Assembly

- (2) M6x1-25mm Hex Bolts
- (4) M6 Large Flat Washers
- (2) M6 Nylon Lock Nuts

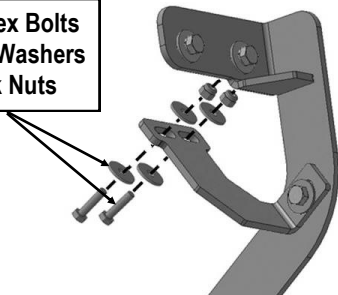

(Fig 13) Driver Side Front Brackets Assembly



(Fig 14) Driver Side Front Brackets Installed

STEP 6

Move to the Driver Side 2nd & 3rd Mounting locations, (Figs 4B& 4C). Repeat Steps 2-5 to install and assemble the Driver Center Mounting Bracket and the Driver Front Support Bracket, (Figs 15 & 16).

Note: Driver Front & Center Mounting Bracket are universal; Driver Front & Center Support Bracket are universal.



(Fig 15) Driver Side 2nd Brackets Installed

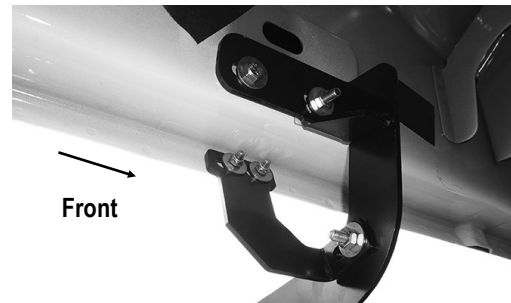

(Fig 16) Driver Side 3rd Brackets Installed

STEP 7

Move to the driver side rear of the vehicle, locate the factory oval hole in the rear corner of the cab, (Fig 17). Partially thread (1) M10 Plastic Washer onto (1) M10 Bolt/Nut Plate. Insert the Bolt/Nut Plate into the hole similar as described in Step 3, (Fig 18). Select the Driver Rear Mounting Bracket (DRM), attach the rear Bracket to the Bolt Plate with (1) M10 Flat Washer, (1) M10 Lock Washer and (1) M10 Hex Nut, (Fig 19). Do not fully tighten the hardware at this time.



(Fig 17) Driver Side Rear Mounting Location

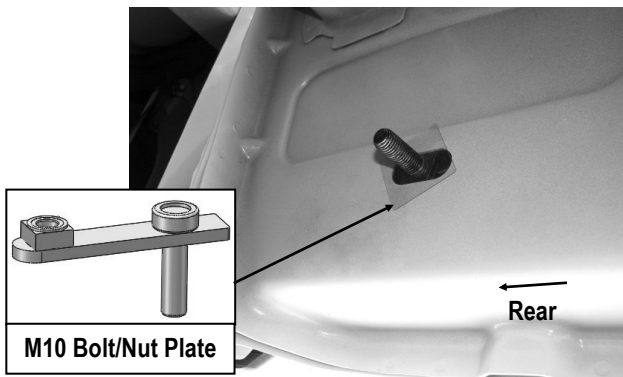

(Fig 18) Insert The M10 Bolt/Nut Plate (Try To Keep The Bolt Plate In The Center Of The Slot When Installing The Rear Bracket Only)

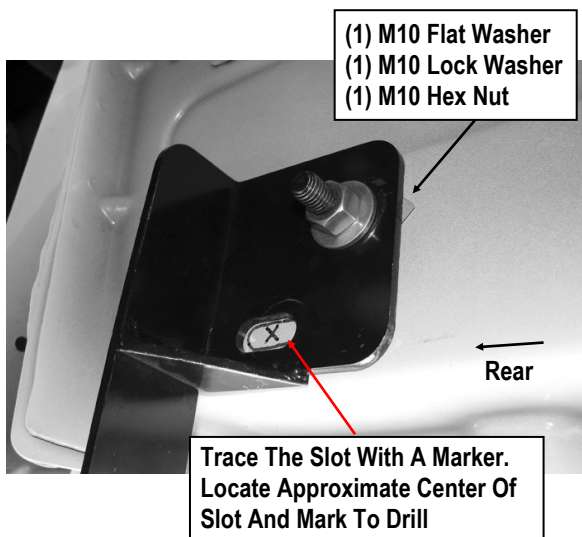

(Fig 19) Driver Side Rear Mounting Bracket Installation

STEP 8

Optional Rear Bracket Installation (requires drilling-highly recommended for heavy duty use):

Once **Step 7** has been completed, loosen the Hex Nut on the M10 Bolt/Nut Plate and center the threaded end in the slot in the Bracket and the vehicle, (**Fig 20**). Trace the open, unused slot in the bracket mounting plate onto the body panel.

Remove the Rear Bracket and M10 Bolt/Nut Plate. Mark the center of the slot. Carefully drill the location with a 7/16" drill bit, (**Figs 19 & 20**). **IMPORTANT!** Any cutting or drilling tool may break or shatter. Government regulations require safety glasses & equipment at all times when drilling.

Reinstall the M10 Bolt/Nut Plate and Rear Mounting Bracket as previously described in **Step 6**. Rotate the M10 Bolt/Nut Plate around to line up with the drilled hole. Insert (1) M10x1.5-30mm Hex Bolt, (1) M10 Lock Washer and (1) M10 Flat Washer through the Bracket, hole and into the M10 Bolt/10mm Nut Plate, (**Fig 21**). Do not fully tighten hardware at this time.



(Fig 20) Use A 7/16" Drill Bit To Drill Hole In Center Of Slot As Marked

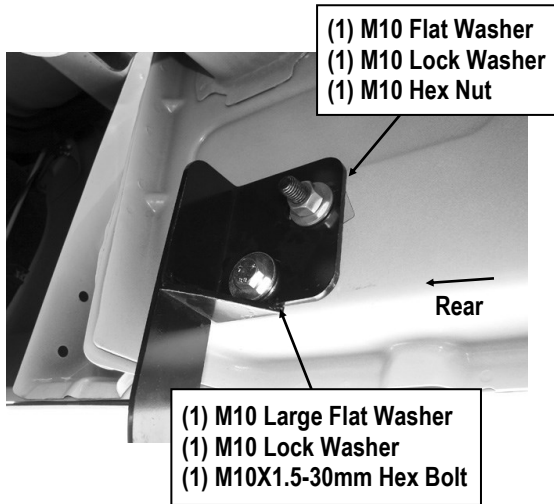

(Fig 21) Driver Side Rear Mounting Bracket Installation

STEP 9

Once all (4) Driver side mounting brackets are installed, then proceed to the Step Bar installation. (Figs 22 & 23)

- (1) Select (1) Slider and (2) M8X1.25-35mm Carriage Bolts;
- (2) Install (2) M8X1.25-35mm Carriage Bolts in (1) Slider.
- (3) Slide the Slider (with carriage bolts) to the **Step Bar**.
- (4) Repeat to install the other (3) sliders to the step bar.
- (5) Attach the Step Bar (with the Sliders) onto the installed mounting brackets. Position the Sliders to the installed brackets. Secure the Step Bar to the installed Brackets by using (8) M8 Large Flat Washers and (8) M8 Nylon Lock Nuts and (4) Sliders, (Fig 23). Do not fully tighten hardware at this time.

Note: The Sliders are packed with the Step Bars.

Level and adjust the Step Bar and fully tighten all hardware.

Repeat **Steps 2-9** for the other side Step Bar installation. **The installation is completed!!!**

STEP 10

Some Models requiring **drilling** for Driver Side Support Bracket (DFS/DCS):

- a. Make sure the sidebar is level to the vehicle. Line up the slot on the Support Bracket with the back of the pinch weld. Mark the location of the slot onto the pinch weld.
- b. Drill (2) ¼" holes through the pinch weld. **Important:** Do not drill too close to the bottom edge of the pinch weld. Drill the holes toward the outside of the marked slot.
- c. Attach the Support Bracket to the pinch weld with (2) M6 X1-25mm Hex Bolts, (4) M6 Large Flat Washers, (2) M6 nylon Lock Nuts, (Figs 13 & 14).
- d. Check for level then fully tighten all hardware.

STEP 11

Repeat **Steps 2-11** for the other side Step Bar installation. The installation is completed.

Attention

Do periodic inspections to the installation to make sure that all hardware is secure and tight.

In order to protect your bars/boards, please use mild soap/non-abrasive products for cleaning only.

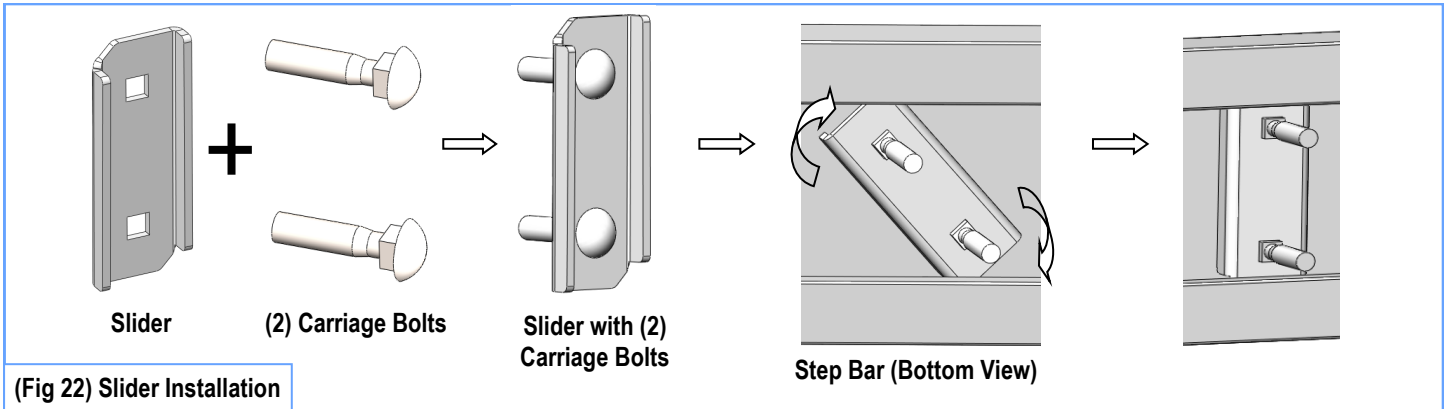

(Fig 22) Slider Installation

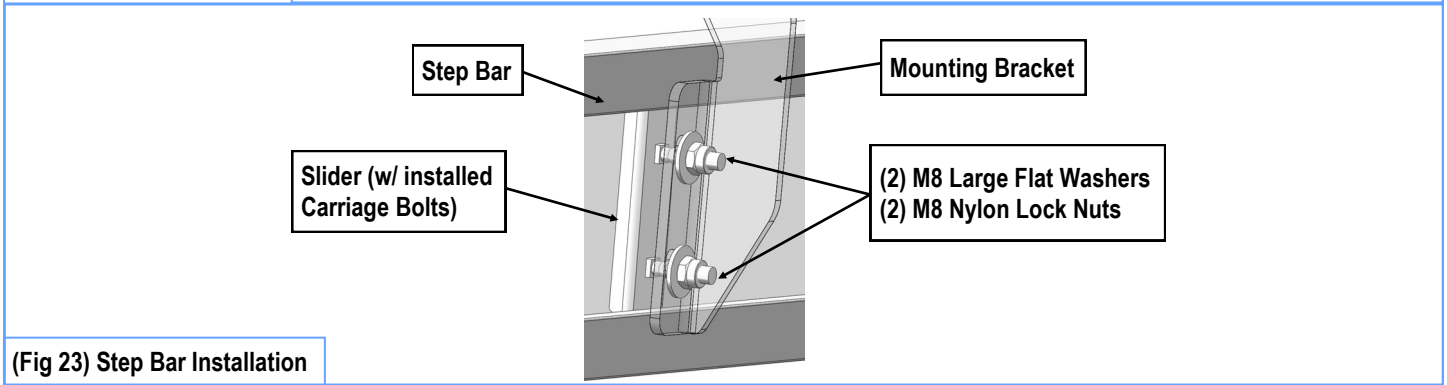

(Fig 23) Step Bar Installation