



iBoard® by APS

PART#: IB-179L&208[L,S] C&H

READ INSTRUCTIONS CAREFULLY BEFORE STARTING INSTALLATION. REMOVE CONTENTS FROM BOX AND VERIFY ALL PARTS ARE PRESENT. ASSISTANCE IS RECOMMENDED.

*ROCKER PANEL MOUNT
*DRILLING MAY BE REQUIRED

Fastener Size	Tightening Torque (ft-lbs)	Required
6mm	6-7	√
8mm	16-18	√
10mm	31-32	√
12mm	56-58	X
14mm	92-94	X

PART LIST

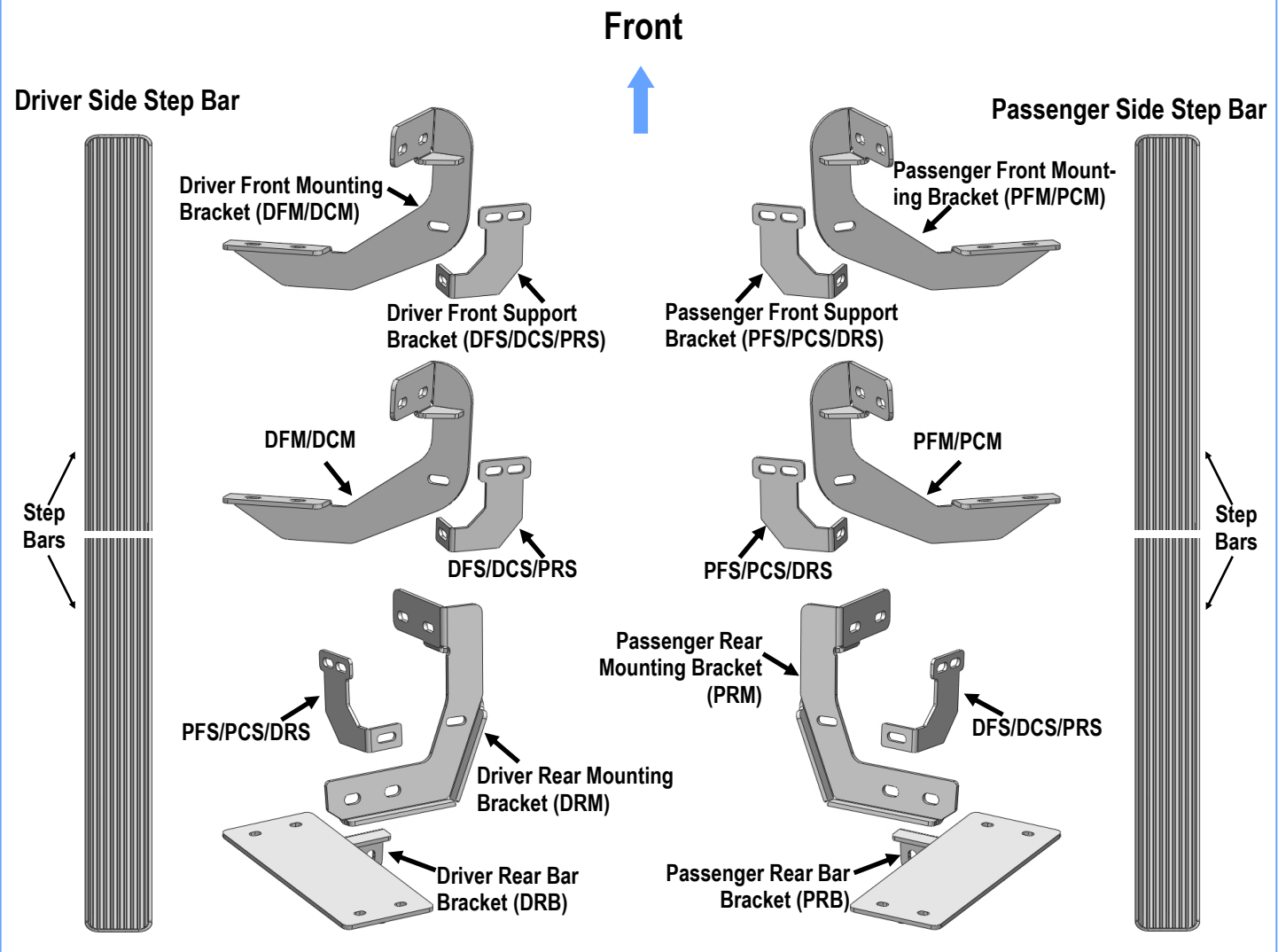





Hardware Package A (For Bracket Installation)					
Item	QTY	Description	Item	QTY	Description
1#	6	M8 Bolt Plates	8#	24	M8 Large Flat Washers
2#	6	Plastic Washers	9#	12	M8 Lock Washers
3#	4	M10X1.5-30mm Hex Bolts	10#	6	M8X1.25 Hex Nuts
4#	8	M10 Flat Washers	11#	6	M8X1.25 Nylon Lock Nuts
5#	4	M10 Lock Washers	12#	12	M6X1-25mm Hex Bolts
6#	4	M10X1.5 Hex Nuts	13#	24	M6 Large Flat Washers
7#	18	M8X1.25-30mm Hex Bolts	14#	12	M6X1 Nylon Lock Nuts

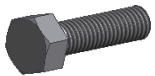

1 #



2 #



3 #

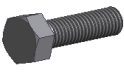

4 #



5 #



6 #



7 #



8 #

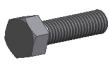

9 #

10 #



11 #



12 #

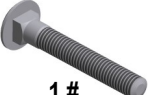

13 #



14 #

Hardware Package B (For Stainless Steel Step Bar Installation)					
Item	QTY	Description	Item	QTY	Description
1#	16	M8X1.25-35mm Carriage Bolts	3#	16	M8 Nylon Lock Nuts
2#	16	M8 Large Flat Washers	4#	8	Sliders (Packed with Step Bars)



1 #

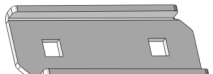

2 #



3 #



4 #

Hardware Package C (For Stainless Steel Step Bar Assembly)					
Item	QTY	Description	Item	QTY	Description
1#	8	Plastic Rivets	5#	4	M8 Hex Nuts
2#	12	M8X1.25-25mm Inner Hex Bolts	6#	2	Plastic Covers (Packed with Step Bars)
3#	16	M8 Flat Washers	7#	2	Back Plates (Packed with Step Bars)
4#	12	M8 Lock Washers			



1 #



2 #

3 #

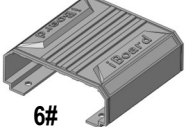
4 #

5 #

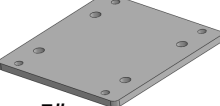
6 #



7 #



STEP 1

Step Bar Assembly:

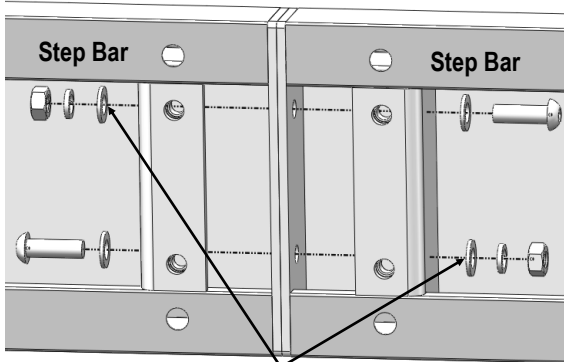
1. Select and assemble (2) Step Bars with (2) M8X1.25-25mm Inner Hex Bolts, (4) M8 Flat Washers, (2) M8 Lock Washers and (2) M8 Hex Nuts, **(Fig 1). NOTE: (4) Step Bars are universal.**
2. Attach (1) Back Plate to the bottom of the installed (2) Step Bars with (4) M8X1.25-25mm Inner Hex Bolts, (4) M8 Flat Washers, (4) M8 Lock Washers, **(Fig 2).**
3. Install (1) Plastic Cover to cover the joint of (2) Step bars with (4) Plastic Rivets, **(Fig 3).**
4. Repeat to assemble the other (2) Step Bars.



- (2) M8X1.25-25mm Inner Hex Bolts
- (4) M8 Flat Washers
- (2) M8 Lock Washers
- (2) M8 Hex Nuts

(Fig 1) Step Bars Assembly

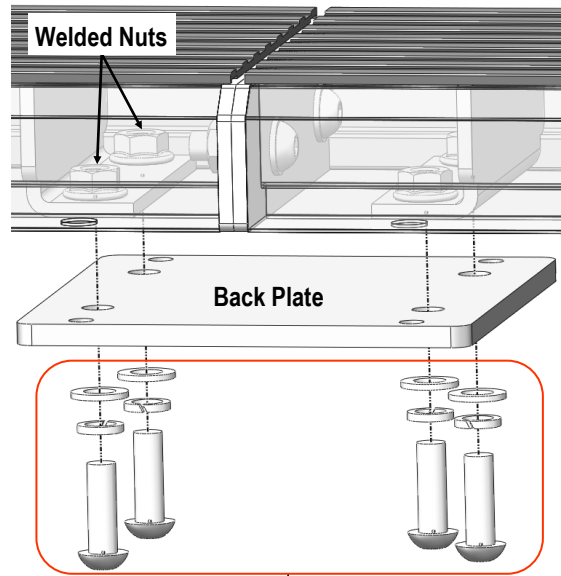

- (4) M8X1.25-25mm Inner Hex Bolts
- (4) M8 Flat Washers
- (4) M8 Lock Washers

(Fig 2) Back Plate Installation

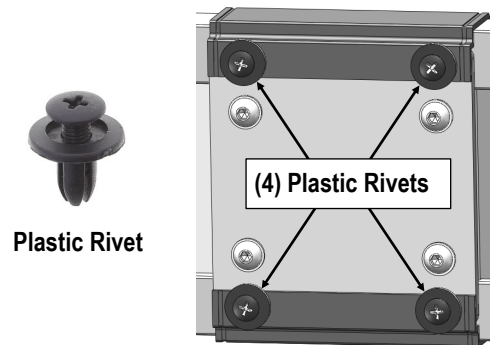

(Fig 3) Plastic Cover Installation
(Bottom View)

Assembled Step Bars





STEP 2

Start installation from the driver side front mounting location of the vehicle. Remove the sealing tapes covering the factory holes in the inner of body panel, (Fig 4).

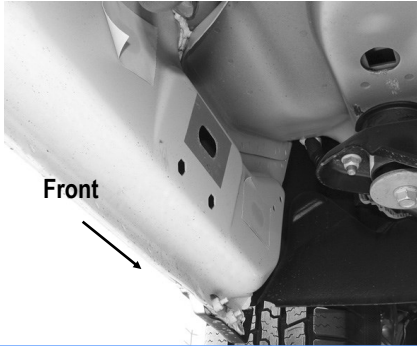

(Fig 4) 2009-Mid 2015 Driver Front Mounting Location
(No Factory Holes In Pinch Weld on Some Models)

STEP 3

Determine the correct procedure to attach the driver side Brackets for your model/year:

Models without factory threaded inserts on body panel:

- a. Select (1) M8 Bolt Plate, (Fig 5). Partially thread the M8X1.25-30 Hex Bolt into the welded nut on the Bolt Plate until it is flush with the welded nut, (Fig 6). Use the Hex Bolt as a handle and insert the Nut/Bolt Plate into the oval hole, (Fig 7). Feed the threaded bolt on the Bolt Plate through one of the hex shaped factory holes. Thread (1) Plastic Washer onto the welded bolt and down tight against the body panel, (Fig 8). **NOTE:** The Plastic Washer is designed to keep the Bolt Plate out falling into the body panel and to aid in Bracket installation.
- b. Attach (1) Driver Front Mounting Bracket (DFM/DCM) to the welded bolt of the M8 Bolt Plate on the driver side front location with (1) M8 Flat Washer, (1) M8 Lock Washer and (1) M8X1.25 Hex Nut, (Fig 9a).

Remove the M8X1.25-30 Hex Bolt from the Bolt Plate. Hold the welded bolt and rotate the Bolt Plate until the welded nut lines up with the remaining hole on the Mounting Bracket. Do not fully tighten hardware at this time.

C. Secure the Driver Front Mounting Bracket to the welded nut on the M8 Bolt Plate with (1) M8x1.25-30 Hex Bolt, (1) M8 Lock Washer and (1) M8 Flat Washer (Fig 9b). Do not fully tighten hardware at this time.



(Fig 5) M8 Bolt Plate (NOTE: M8 Bolt Plate is not required on models with threaded inserts on body panel)

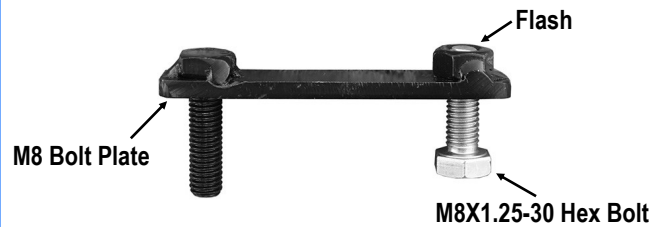

(Fig 6) Thread (1) M8X1.25-30 Hex Bolt into the welded nut on the plate. (Stop when bolt reaches end of nut as pictured)

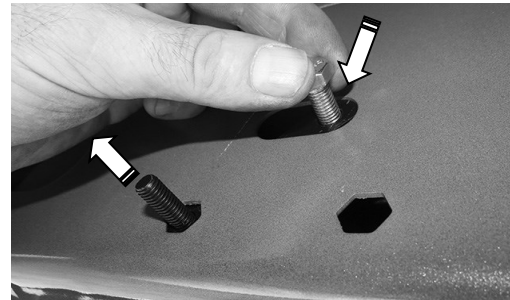

(Fig 7) Use the loose Hex Bolt as a handle. Insert the Bolt Plate into the oval hole and feed the threaded bolt out either factory hex shaped hole. **IMPORTANT:** Do not let go of the hex bolt until after Plastic Washer has been threaded onto bolt (Fig 8).

M8 Plastic Washer (example)

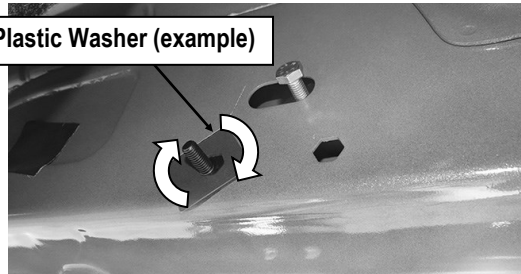

(Fig 8) Thread Plastic Washer onto the welded bolt to hold Bolt Plate in position

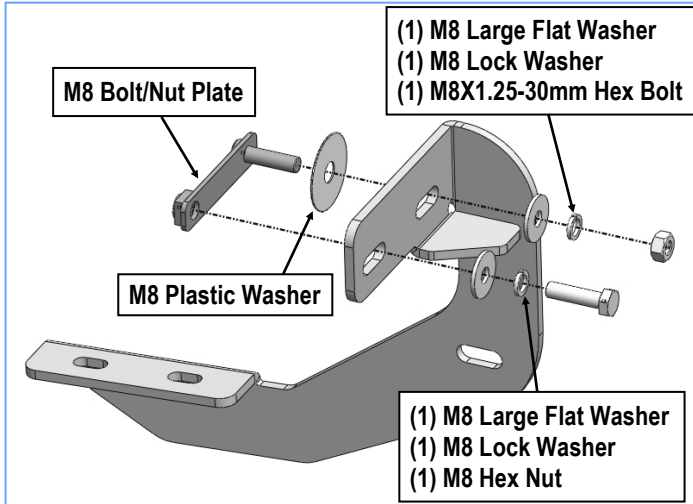

(Fig 9) Driver Front Mounting Bracket Installation

Models with factory threaded inserts on body panel:

Attach Driver Front Mounting Bracket (DFM/DCM) to the threaded inserts with (2) M8x1.25-30 Hex Bolts, (2) M8 Lock Washers and (2) M8 Flat Washers, (Fig 10 & 11). Leave hardware loose.

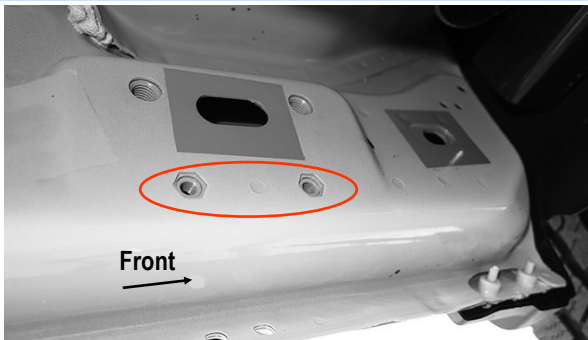

(Fig 10) Driver Side Front Mounting Location (Mid 2015-On, An Example Of Models With Factory Installed Threaded Inserts)

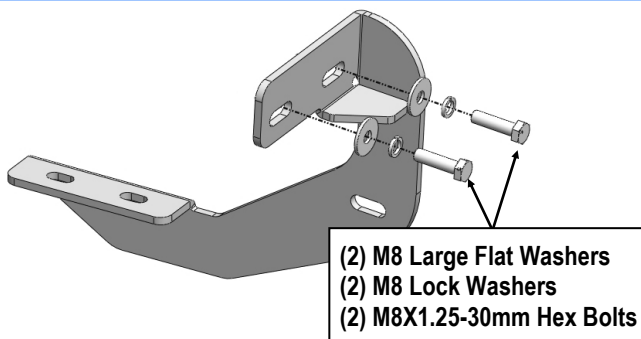

(Fig 11) Driver Front Mounting Bracket Installation

STEP 4

Attach the Driver Front Support Bracket (DFS/DCS/PRS) to the Driver Front Mounting Bracket (DFM/DCM) with (1) M8x1.25-30 Hex Bolt, (2) M8 Large Flat Washers and (1) M8X1.25 Nylon Lock Nut, (Fig 12). Rotate the support bracket to the back of the pinch weld. Line up the slots on the Support Bracket with the (2) factory holes on the pinch weld. Attach the Bracket to the back of the pinch weld with (2) M6x1-25 Hex Bolts, (4) M6 Large Flat Washers and (2) M6X1 Nylon Lock Nuts, (Fig 13). Do not fully tighten hardware at this time.

IMPORTANT: Some models are not equipped with factory holes on pinch weld and will require drilling through holes on the pinch weld to attach the Support Bracket. Do not drill through pinch weld at this time, (Refer to Step 9).

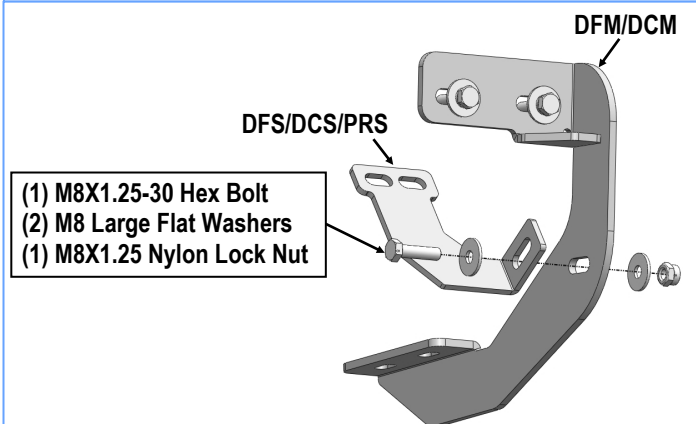

(Fig 12) Attach Driver Front Support Bracket to the Driver Front Mounting Bracket

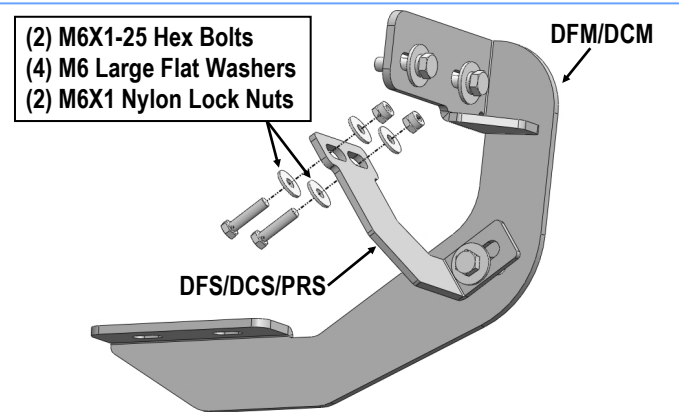

(Fig 13) Attach Support Bracket to the Back of Pinch Weld (Some Models May Require to Drill Holes on Pinch Weld)



STEP 5

Move to the Driver Side Center Mounting location, (Fig 14). Repeat **Steps 2-4** to install the Driver Side Center Brackets, (Fig 15). Do not fully tighten hardware at this time.

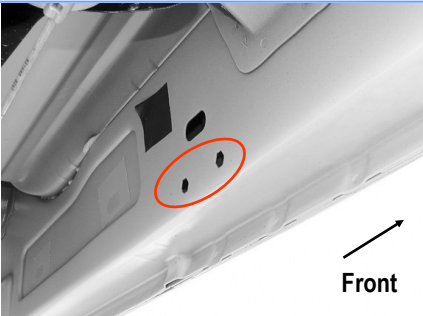

(Fig 14) Driver Side Center Mounting Location

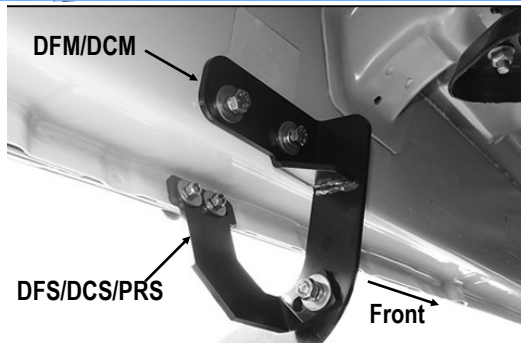

(Fig 15) Driver Side Center Brackets Installed

STEP 6

Move to the Driver Side Rear Mounting location, (Fig 16). Repeat **Steps 2-4** to install the Driver Rear Mounting Bracket (DRM) and Driver Rear Support Bracket (PFS/PCS/DRS), (Fig 17). Do not tighten hardware at this time.

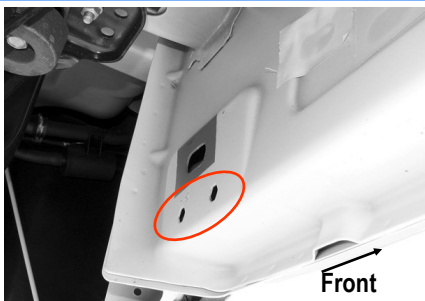

(Fig 16) Driver Side Rear Mounting Location

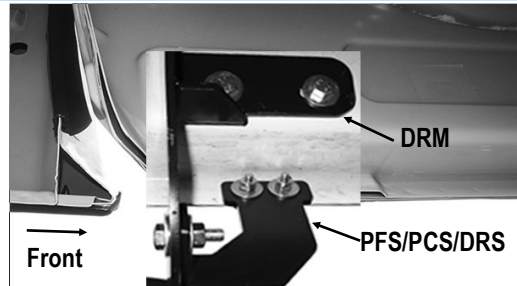

(Fig 17) Driver Side Rear Brackets Installed

STEP 7

Select the Driver Rear Bar Bracket (DRB), bolt to the Driver Rear Mounting Bracket (DRM) with (2) M10X1.5-30 Hex Bolts, (2) M10 Lock Washers, (4) M10 Flat Washers and (2) M10X1.5 Hex Nuts. (Fig 18). Do not fully tighten hardware at this time.

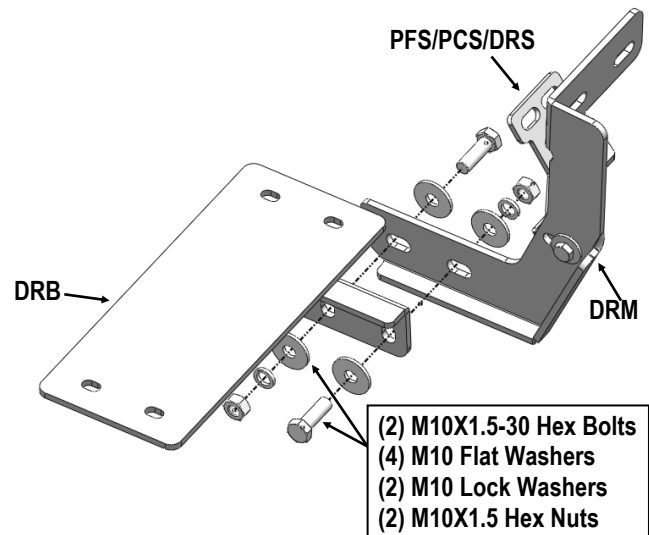

(Fig 18) Driver Side Rear Bar Bracket Assembly

STEP 8

Once all (3) Driver side mounting brackets are installed, then proceed to the Step Bar installation. (Figs 19 & 20)

- (1) Select (1) Slider and (2) M8X1.25-35mm Carriage Bolts;
- (2) Install (2) M8X1.25-35mm Carriage Bolts in (1) Slider.



- (3) Slide the Slider (with carriage bolts) to the **Step Bar**.
- (4) Repeat to install the other (2) sliders to the step bar.
- (5) Attach the Step Bar (with the Sliders) onto the installed mounting brackets. Position the Sliders to the installed brackets. Secure the Step Bar to the installed Brackets by using (8) M8 Large Flat Washers and (8) M8 Nylon Lock Nuts and (4) Sliders, **(Fig 20)**. Do not fully tighten hardware at this time.

Note: The Sliders are packed with the Step Bars.

Level and adjust the Step Bar and fully tighten all hardware.

STEP 9

Models requiring drilling for driver side Support Brackets:

- a.** Make sure the Step Bar is level to the vehicle. Adjust and tighten all mounting hardware.
- b.** Line up the slots on the Support Brackets with the back of the pinch weld. Mark the location of the slots onto the pinch weld.
- c.** Drill (2) 1/4" holes through the pinch weld for each Support Bracket. **IMPORTANT:** Do not drill too close to the bottom edge of the pinch weld. Adjust the Brackets as necessary to move the slots up the body panel away from the edge. Drill the holes toward the outside of the marked slots.
- d.** Attach each Support Brackets to the pinch weld with (2) M6X1-25 Hex Bolts, (4) M6 Large Flat Washers and (2) M6X1 Nylon Lock Nuts, **(Fig 15)**. Check for level then fully tighten all hardware.

STEP 10

Level and adjust the Step Bar and fully tighten all hardware. Repeat **Steps 2-9** for the other side Step Bar installation.

The installation is completed.

Attention

Do periodic inspections to the installation to make sure that all hardware is secure and tight.

In order to protect your bars/boards, please use mild soap/non-abrasive products for cleaning only.

