

iBoard®

iBoard® by APS

PART#: IB-252

READ INSTRUCTIONS CAREFULLY BEFORE STARTING INSTALLATION. REMOVE CONTENTS FROM BOX AND VERIFY ALL PARTS ARE PRESENT. ASSISTANCE IS RECOMMENDED.

*ROCKER PANEL MOUNT
*NO DRILLING REQUIRED

Fastener Size	Tightening Torque (ft-lbs)	Required
6mm	6-7	√
8mm	16-18	X
10mm	31-32	√
12mm	56-58	X
14mm	92-94	X

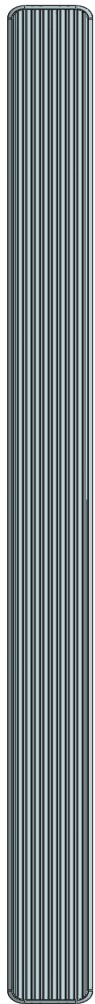

Driver Side Step Bar

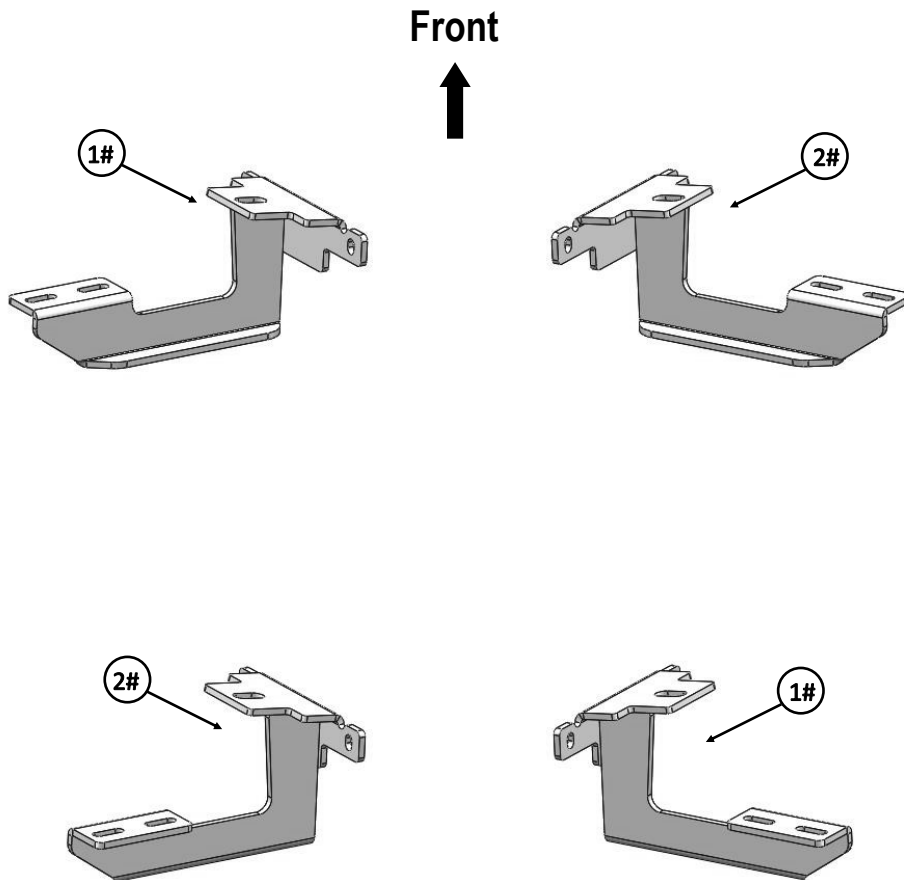



Passenger Side Step Bar

iBoard®

Mounting Bracket List					
Item	QTY	Description	Item	QTY	Description
1#	2	Driver Front / Passenger Rear Mounting Brackets	2#	2	Passenger Front / Driver Rear Mounting Brackets

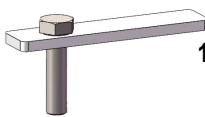
Hardware Package A (For Bracket Installation)					
Item	QTY	Description	Item	QTY	Description
1#	4	M10 Bolt Plates	5#	8	M6X1-25mm Hex Bolts
2#	4	M10 Plastic Washers	6#	8	M6 Large Flat Washers
3#	4	M10 Flat Washers	7#	8	M6 Flat Washers
4#	4	M10X1.5 Hex Flange Nuts	8#	8	M6X1 Nylon Lock Nuts

 1 #

 2 #

 3 #

 4 #

 5 #

 6 #

 7 #

 8 #

Hardware Package B (For Aluminum Step Bar Installation Only, Not Supply to SS. Step Bar)					
Item	QTY	Description	Item	QTY	Description
1#	8	M6X1-20mm Square Head Bolts	3#	8	M6X1 Nylon Lock Nuts
2#	8	M6 Large Flat Washers			

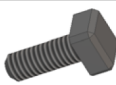
 1 #

 2 #

 3 #

Hardware Package C (For Stainless Steel Step Bar Installation Only, Not Supply to Aluminum Step Bar)					
Item	QTY	Description	Item	QTY	Description
1#	8	M6X1-20mm Hex Bolts	3#	8	M6 Flat Washers
2#	8	M6 Lock Washers			

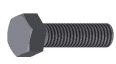
 1 #

 2 #

 3 #

iBoard®

STEP 1

Starting at the driver side, locate the (2) pairs of factory holes in the pinch weld, **(Fig 1 & 2)**. Move toward the front pair. Remove the rubber plug coving the oval hole in the bottom of the rocker panel in front of the two holes, **(Fig 3)**.

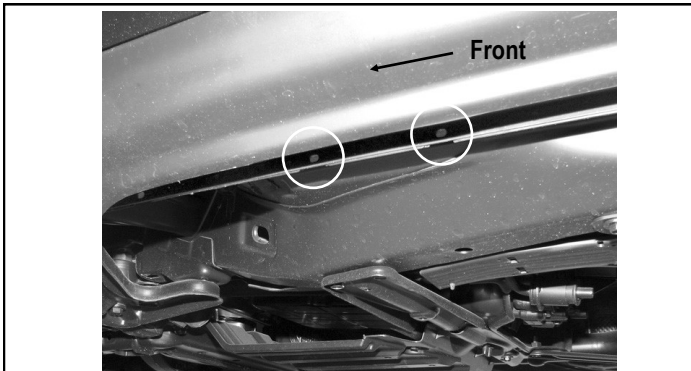

(Fig 1) Drive Front Mounting Bracket Location

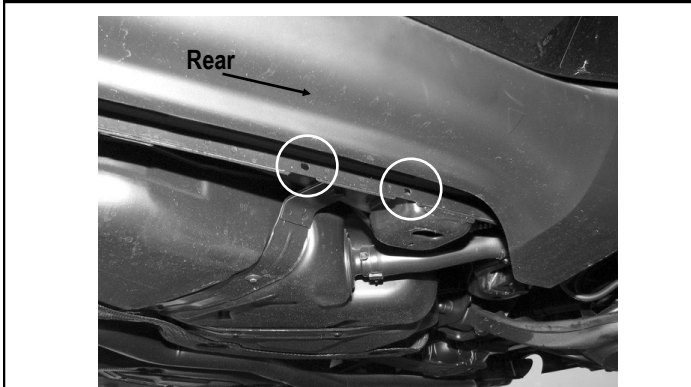

(Fig 2) Driver Rear Mounting Bracket Location

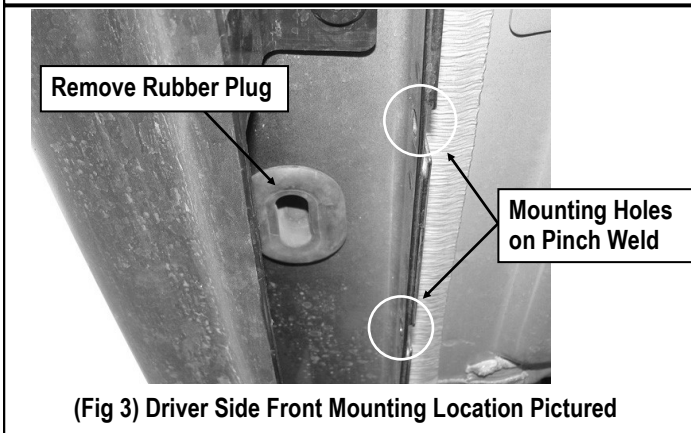

(Fig 3) Driver Side Front Mounting Location Pictured

STEP 2

Select (1) M10 Bolt Plate and (1) M10 Plastic Washer. Partially thread the M10 Plastic Washer onto the Welded Bolt. Insert the M10 Bolt Plate into the oval hole and rotate across the slot, **(Fig 4)**. Thread the M10 Plastic Washer all the way down the Welded Bolt and tight against the body panel.

NOTE: The M10 Plastic Washer is designed to prevent the Bolt Plate from falling into the body panel and hold the bolt plate in place within the bracket installation.

After inserting, rotate M10 Bolt Plate across the slot or until M10 Bolt Plate stopped.

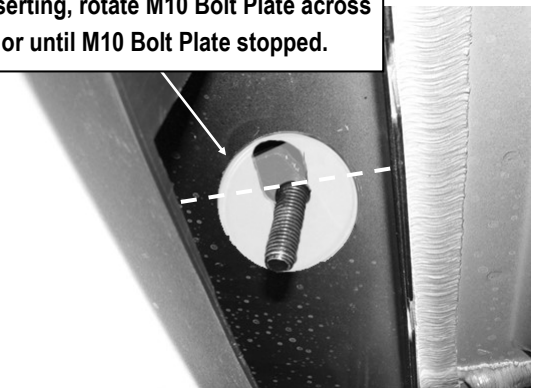

(Fig 4) M10 Bolt Plate Installed on Driver Side Front Mounting Location

STEP 3

Attach the Driver Front Mounting Bracket to the installed M10 Bolt Plate with (1) M10 Flat Washer and (1) M10x1.5 Hex Flange Nut, **(Figs 5-7)**.

Line up the (2) small slots on the Driver Front Mounting Bracket with the (2) holes on the pinch weld. Bolt the Driver Front Mounting Bracket to the outside of the pinch weld with (2) M6x1-25mm Hex Bolts, (2) M6 Large Flat Washers (outside against Bracket), (2) M6 Flat Washers (inside against pinch weld) and (2) M6x1 Nylon Lock Nuts, **(Figs 5-7)**. Do not fully tighten hardware at this time.

iBoard®

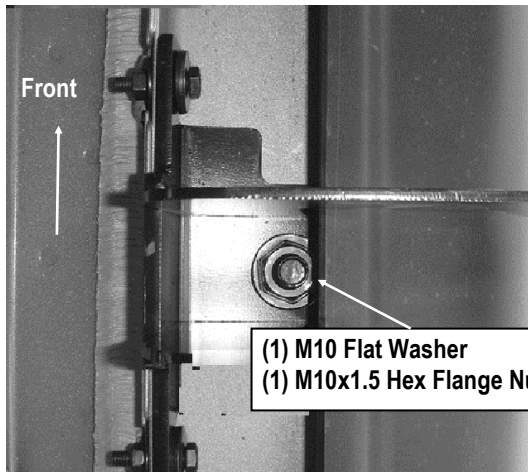

(Fig 5) Driver Front Mounting Bracket Installation

- (2) M6x1-25mm Hex Bolts
- (2) M6 Large Flat Washers (outside)
- (2) M6 Flat Washers (inside)
- (2) M6x1 Nylon Lock Nuts

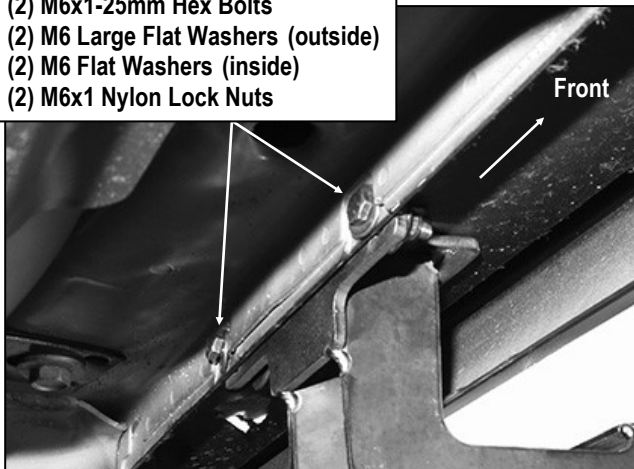

(Fig 6) Driver Front Mounting Bracket Installation

STEP 4

Repeat **Steps 2-3** to install the Driver Rear Mounting Bracket. Do not fully tighten hardware at this time.

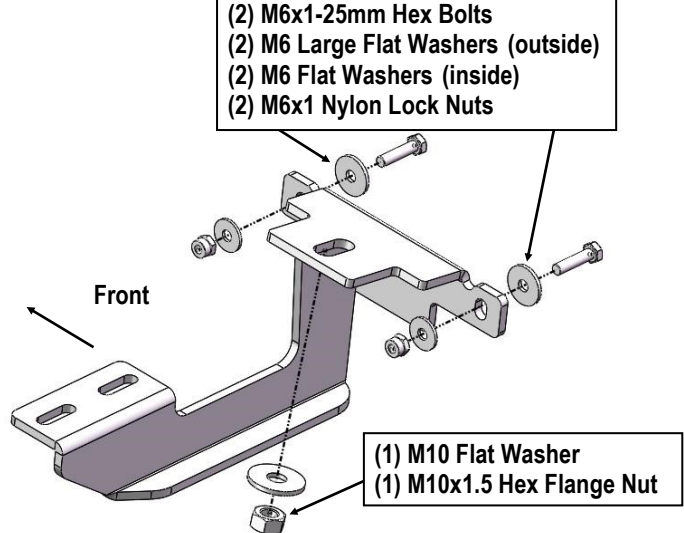

(Fig 7) Driver Front Mounting Bracket Installation

STEP 5

Once all (2) mounting brackets are installed, then proceed to the Step Bar installation. According to the style of Step Bar proceed to the correct installation STEPS.

Note: Aluminum Step Bar refer to **STEP 6**; Stainless Steel Step Bar skip to **STEP 7**.

STEP 6

Aluminum Step Bar Installation:

Select a **Aluminum Step Bar**. Slip (2) M6x1-20mm Square Head Bolts into each bottom channel (**Fig 8**). Carefully position the Step Bar onto the (2) Mounting Brackets.

IMPORTANT: Do not slide the Step Bar on the Brackets or the bottom surface of the board will be damaged. Attach the Step Bar to each Mounting Brackets with (2) M6x1-20mm Square Head Bolts, (2) M6 Large Flat Washers and (2) M6X1 Nylon Lock Nuts, (**Fig 9**). Do not fully tighten at this time.

Level and adjust the Step Bar and fully tighten all hardware. Repeat **Steps 1-6** for the other side Step Bar installation. **The installation is completed!!!**

iBoard®



(Fig 8) Slip M6X1-20mm Square Head Bolts Into The Bottom Channels



(Fig 10) Slide & line up the U-Slider with the installed mounting brackets along bottom channel

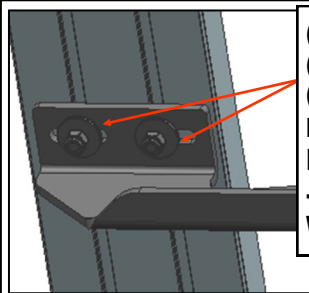

(2) M6X1-20mm Square Head Bolts
(2) M6 Large Flat Washers
(2) M6X1 Nylon Lock Nuts
IMPORTANT: TORQUE FOR 6MM FASTNERS MUST LESS THAN 6-7 FT-LBS OR THE FASTNERS WILL BE DAMAGED!

(Fig 9) Running Board Installed Onto Mounting Bracket

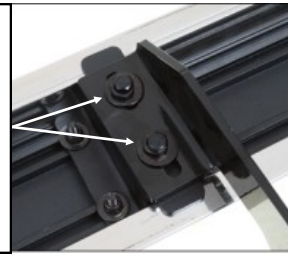

(2) M6X1-20mm Hex Bolts
(2) M6 Large Flat Washers
(2) M6 Lock Washers
IMPORTANT: TORQUE FOR 6MM FASTNERS MUST LESS THAN 6-7 FT-LBS OR THE FASTNERS WILL BE DAMAGED!

(Fig 11) Step Bar Installed on Bracket Installed (Example)

STEP 7

Stainless Steel Step Bar Installation:

Select a **Stainless Steel Step Bar** (with the U-Sliders installed on the Bar). Loose the U-Sliders, reposition the U-Sliders onto the board according to the (2) Installed Mounting Brackets location, (Fig 10). Re-secure the U-Sliders on the Step Bar. Attach the Step Bar to the installed Mounting Brackets with (4) M6X1-20mm Hex Bolts, (4) M6 Large Flat Washers & (4) M6 Lock Washers, (Fig 11). Do not fully tighten hardware at this time. Level and adjust the Step Bar and fully tighten all hardware. Repeat **Steps 1-5 and 7** for the other side Step Bar installation. **The installation is completed!!!**

Attention

Do periodic inspections to the installation to make sure that all hardware is secure and tight.

In order to protect your bars/boards, please use only mild soap/non-abrasive products for cleaning.