

iBoard®



Scan for
Installation Video

iBoard® by APS

PART#: IB-149C&H

READ INSTRUCTIONS CAREFULLY BEFORE STARTING INSTALLATION. REMOVE CONTENTS FROM BOX AND VERIFY ALL PARTS ARE PRESENT. ASSISTANCE IS RECOMMENDED.

*BODY FRAME MOUNT
*NO DRILLING REQUIRED

Fastener Size	Tightening Torque (ft-lbs)	Required
6mm	6-7	X
8mm	16-18	√
10mm	31-32	X
12mm	56-58	√
14mm	92-94	X

PART LIST

Driver Side Step Bar

Front

Passenger Side Step Bar

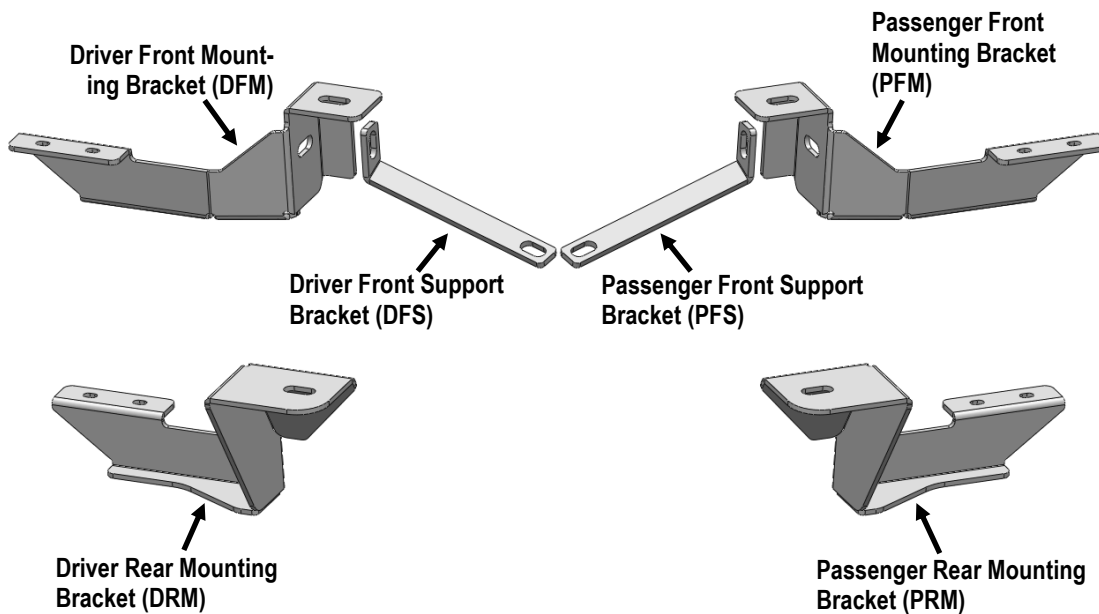
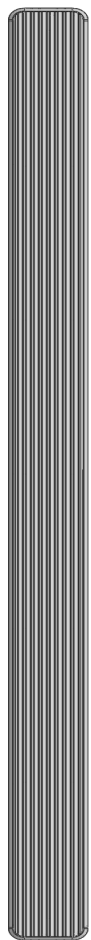

Customer Support: info@iboardauto.com



Hardware Package A (For Bracket Installation)

Item	QTY	Description	Item	QTY	Description
1#	2	M12X1.75-190mm Hex Bolts	4#	4	M12 Lock Washers
2#	2	M12X1.75-40mm Hex Bolts	5#	4	M12X1.75 Hex Nuts
3#	8	M12 Flat Washers			



1#



2#



3#



4#



5#

Hardware Package B (For Stainless Steel Step Bar Installation)

Item	QTY	Description	Item	QTY	Description
1#	8	M8X1.25-35mm Carriage Bolts	3#	8	M8 Nylon Lock Nuts
2#	8	M8 Large Flat Washers	4#	4	Sliders (Packed with Step Bars)

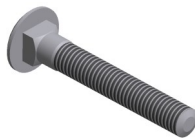

1 #



2 #



3 #



4 #



STEP 1

Start installation from the driver side front of the vehicle. Remove the driver side front body mount bolt.

Assemble (1) Driver Front Mounting Bracket (**DFM**) and (1) Driver Front Support Bracket (**DFS**) with (1) M12X1.75-40mm Hex Bolt, (2) M12 Flat Washers, (1) M12 Lock Washer and (1) M12 Hex Nut, (**Fig 2**). Do not fully tighten hardware at this time.

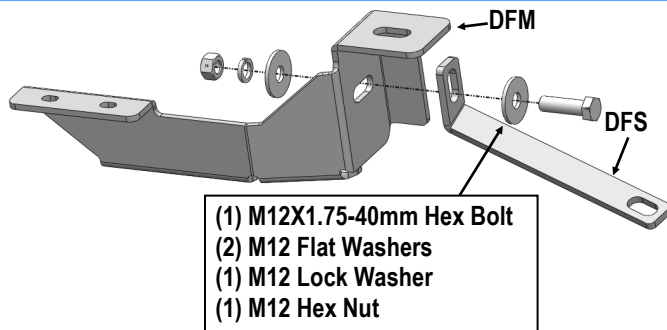

(Fig 1) Driver Side Front Mounting Bracket Assembly

STEP 2

Select (1) Driver Front Mounting Bracket (**DFM**) and (1) Driver Front Support Bracket (**DFS**). Attach the Driver Front Mounting Bracket (**DFM**) to the vehicle with the factory bolt and washer (**Fig 2**). Attach the Driver Front Support Bracket (**DFS**) to the vehicle with (1) M12X1.75-190mm Hex Bolt, (2) M12 Flat Washers, (1) M12 Lock Washer and (1) M12 Hex Nut, (**Fig 2**). Do not fully tighten hardware at this time.

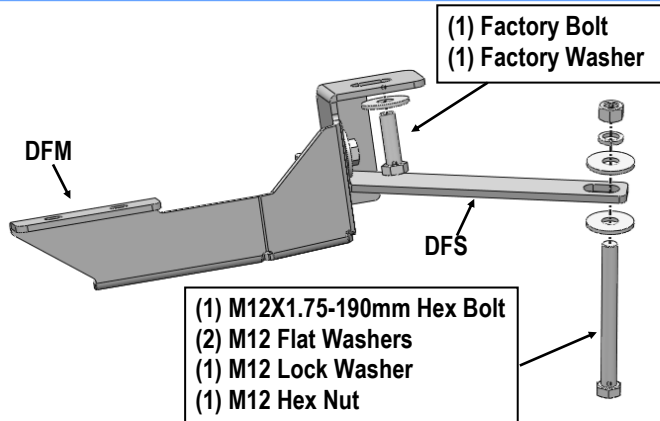

(Fig 2) Driver Front Mounting Brackets Installation

STEP 3

Next, move to the driver side rear of the vehicle. Remove the driver side rear body mount bolt. Attach the Driver Rear Mounting Bracket (**DRM**) with the factory bolt and washer (**Fig 3**). Do not fully tighten hardware at this time.

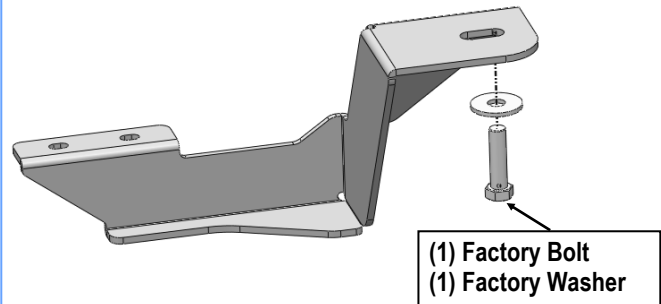

(Fig 3) Driver Rear Mounting Bracket Installation

STEP 4

Once all (2) Driver side mounting brackets are installed, then proceed to the Step Bar installation. (**Figs 4 & 5**)

- (1) Select (1) Slider and (2) M8X1.25-35mm Carriage Bolts;
- (2) Install (2) M8X1.25-35mm Carriage Bolts in (1) Slider.
- (3) Slide the Slider (with carriage bolts) to the **Step Bar**.
- (4) Repeat to install the other (1) slider to the step bar.

(5) Attach the Step Bar (with the Sliders) onto the installed mounting brackets. Position the Sliders to the installed brackets. Secure the Step Bar to the installed Brackets by using (4) M8 Large Flat Washers and (4) M8 Nylon Lock Nuts and (2) Sliders, (**Fig 5**). Do not fully tighten hardware at this time.

Note: The Sliders are packed with the Step Bars.

Level and adjust the Step Bar and fully tighten all hardware.

Repeat **Steps 1-4** for the other side Step Bar installation. **The installation is completed!!!**

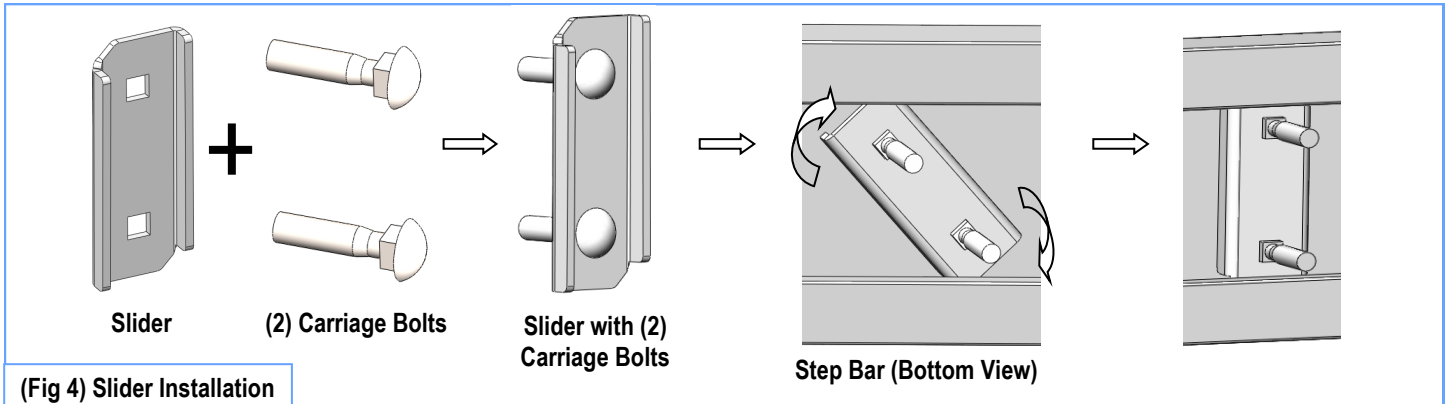

(Fig 4) Slider Installation

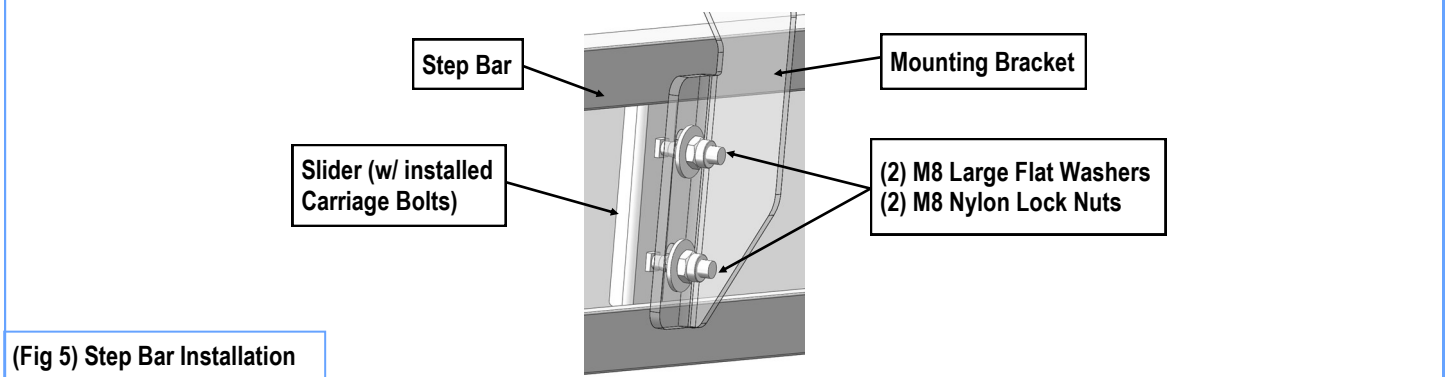

(Fig 5) Step Bar Installation