

iBoard®



Scan for
Installation Video

iBoard® by APS

PART#: IB-179/208/209

READ INSTRUCTIONS CAREFULLY BEFORE STARTING INSTALLATION. REMOVE CONTENTS FROM BOX AND VERIFY ALL PARTS ARE PRESENT. ASSISTANCE IS RECOMMENDED.

*ROCKER PANEL MOUNT
*NO DRILLING REQUIRED

Fastener Size	Tightening Torque (ft-lbs)	Required
6mm	6-7	√
8mm	16-18	√
10mm	31-32	√
12mm	56-58	X
14mm	92-94	X



Driver Side Step Bar

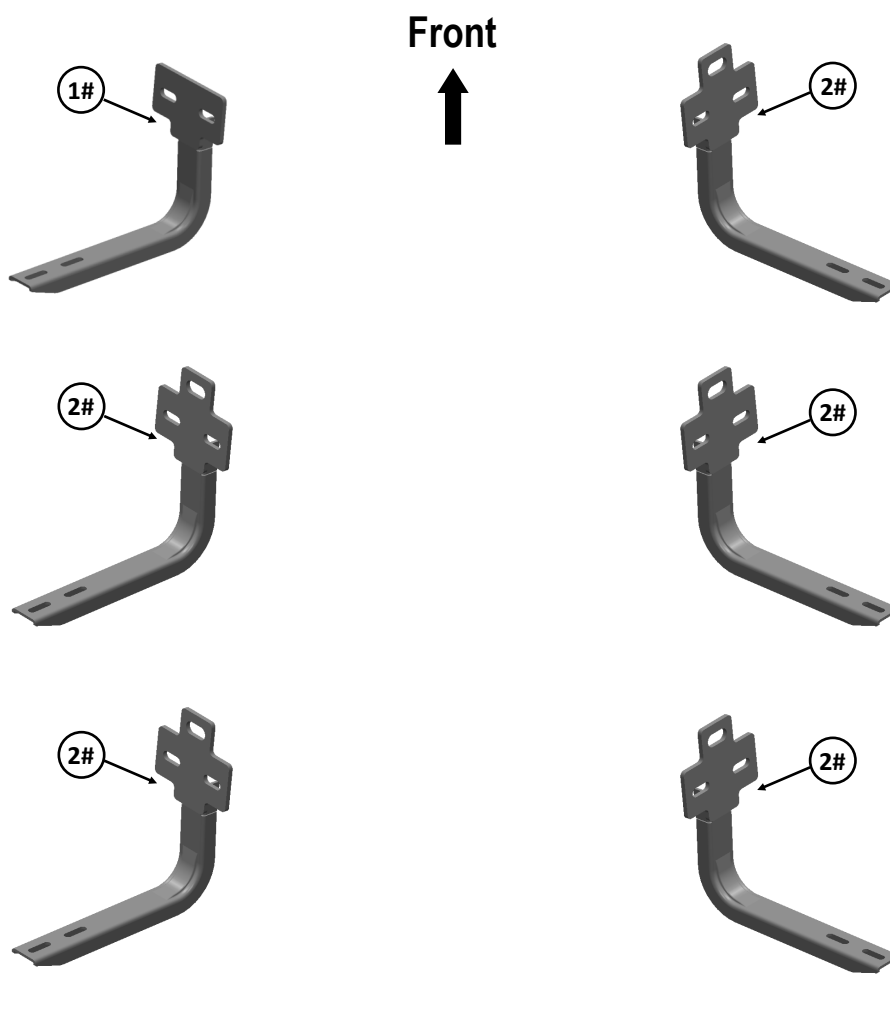

Passenger Side Step Bar

Customer Support: info@iboardauto.com





Mounting Bracket List					
Item	QTY	Description	Item	QTY	Description
1#	1	Driver Front Mounting Bracket	2#	5	Mounting Brackets

Hardware Package A (For Bracket Installation)					
Item	QTY	Description	Item	QTY	Description
1#	6	M8 Bolt Plates	7#	5	M10X1.5 Hex Nuts
2#	5	M10 Bolt Plates	8#	12	M8X1.25-30 Hex Bolts
3#	6	M8 Plastic Washers	9#	12	M8 Large Flat Washers
4#	5	M10 Plastic Washers	10#	12	M8 Lock Washers
5#	5	M10 Large Flat Washers	11#	6	M8X1.25 Hex Nuts
6#	5	M10 Lock Washers			

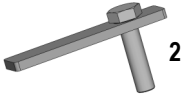
 1 #

 2 #

 3 #

 4 #

 5 #

 6 #

 7 #

 8 #

 9 #

 10 #

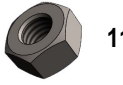
 11 #

Hardware Package B (For Aluminum Step Bar Installation Only, Not Supply to SS. Step Bar)					
Item	QTY	Description	Item	QTY	Description
1#	12	M6X1-20mm Square Head Bolts	3#	12	M6X1 Nylon Lock Nuts
2#	12	M6 Large Flat Washers			

 1 #

 2 #

 3 #

Hardware Package C (For Stainless Steel Step Bar Installation Only, Not Supply to Aluminum Step Bar)					
Item	QTY	Description	Item	QTY	Description
1#	12	M6X1-20mm Hex Bolts	3#	12	M6 Flat Washers
2#	12	M6 Lock Washers			

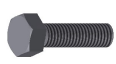
 1 #

 2 #

 3 #



STEP 1

Starting at the driver side front of the vehicle, remove the sealing tape covering the factory holes in the side of the inner panel, (Fig 1).

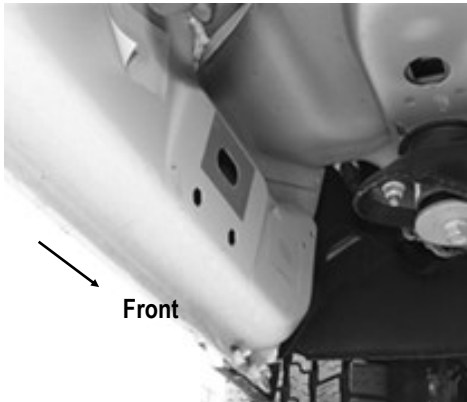

(Fig 1) Example: 09 — mid 15 Driver Side Front Mounting Location

STEP 2

Determine the correct procedure to attach (1) Driver Front Mounting Bracket for your model/year:

Models without factory threaded inserts in body panel:

- Partially thread (1) M8X1.25-30 Hex Bolt into the threaded end on (1) M8 Bolt/Nut Plate (Fig 2). Thread the hex bolt in until it is flush with the welded nut, (Fig 3). Use the hex bolt as a handle and insert the Bolt/Nut Plate into the oval hole, (Fig 4). Feed the threaded bolt on the plate through one of the hex holes. Thread (1) M8 Plastic Washer onto the threaded end and down tight against the body panel, (Fig 5).

NOTE: The Plastic washer is designed to keep the Bolt/Nut Plate from falling into the body panel and to aid in bracket installation.

- Attach (1) Driver Front Mounting Bracket to the threaded end of the installed M8 Bolt/Nut Plate with (1) M8 Large Flat Washer, (1) M8 Lock Washer and (1) M8X1.25 Hex Nut, (Fig 6).

Remove the M8X1.25-30 Hex Bolt from the welded nut on the Bolt/Nut Plate. Rotate the Bolt/Nut Plate until the threaded nut lines up with the remaining hole in the Mounting Bracket and body panel. Do not fully tighten hardware at this time.

- Attach the Driver Front Mounting Bracket to the threaded nut on the M8 Bolt Plate with (1) M8X1.25-30 Hex Bolt, (1) M8 Lock Washer and (1) M8 Large Flat Washer, (Fig 6). Do not fully tighten hardware at this time.



(Fig 2) M8 Bolt/Nut Plate (NOTE: M8 Bolt/Nut Plate is not required on models with threaded inserts)

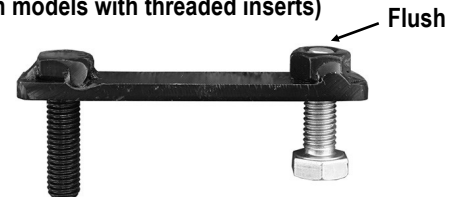

(Fig 3) Thread (1) M8X1.25-30 Hex Bolt into the welded nut on the plate.

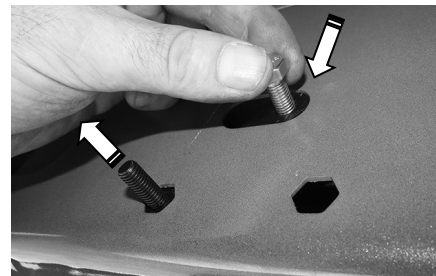

(Fig 4) Use the Hex Bolt as a handle. Insert the Bolt/Nut Plate into the oval hole and feed the threaded end out either factory hex shaped hole.

IMPORTANT: Do not remove the Hex Bolt until the Plastic Washer is threaded onto the welded bolt (Fig 5).

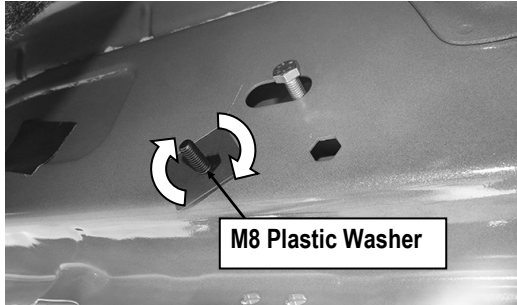

M8 Plastic Washer

(Fig 5) Thread Plastic Washer onto Bolt Plate to hold Bolt Plate in position

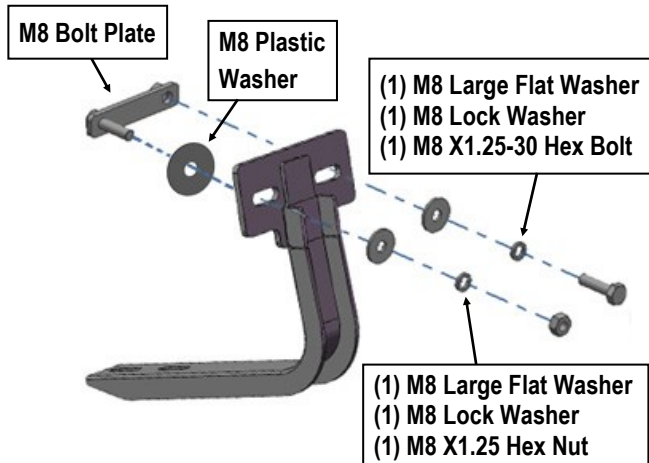

(Fig 6) Driver Front Mounting Bracket Installation
(For Models without factory threaded inserts)

Models with factory threaded inserts:

Attach Driver Front Mounting Bracket to the threaded inserts with (2) M8X1.25-30 Hex Bolts, (2) M8 Lock Washers and (2) M8 Large Flat Washers, (Fig 7 & 8). Leave hardware loose.

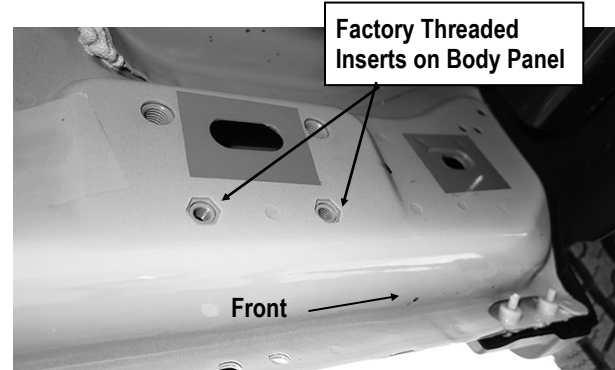

Factory Threaded Inserts on Body Panel

Front

(Fig 7) Driver Side Front Mounting Location mid 15-on
(Example of models with factory installed threaded inserts)

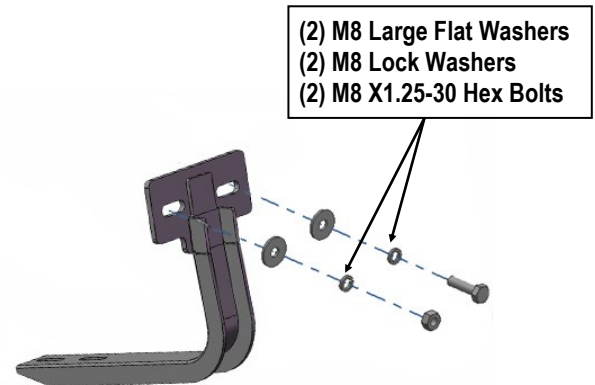

(Fig 8) Driver Front Mounting Bracket Installation
(For Models with factory threaded inserts)

STEP 3

Move along the side of the body panel to the Driver Side Center Mounting Location. Insert (1) M10 Bolt Plate into the upper oval slot (Fig 9). Repeat the **Step 2** to attach the Driver Center Mounting Bracket to the lower (2) holes (Fig 10 & 11). And then secure the bracket to the upper M10 Bolt Plate (Fig 12). Do not fully tighten hardware at this time.

IMPORTANT: Other (5) Mounting Brackets are universal.

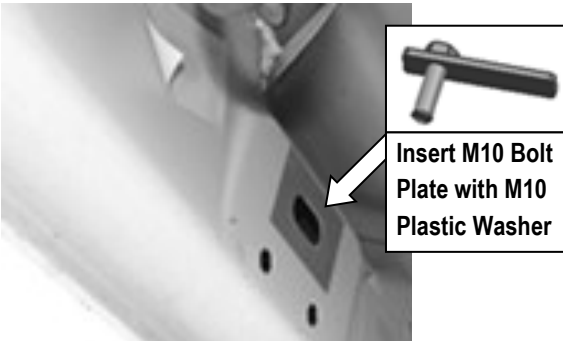

Insert M10 Bolt Plate with M10 Plastic Washer

(Fig 9) Thread M10 Plastic Washer Onto M10 Bolt Plate to Hold M10 Bolt Plate In Place.

Models without factory threaded inserts in body panel:
(2) M8 Large Flat Washers
(2) M8 Lock Washers
(1) M8 X1.25-30 Hex Bolt
(1) M8X1.25 Hex Nut

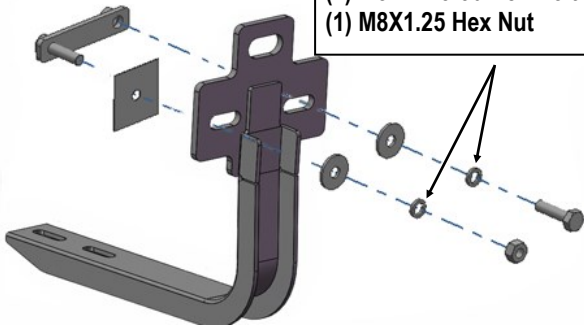

(Fig 10) Driver Center Mounting Bracket Installed to the Lower (2) Holes

Models with factory threaded inserts in body panel:
(2) M8 Large Flat Washers
(2) M8 Lock Washers
(2) M8 X1.25-30 Hex Bolts

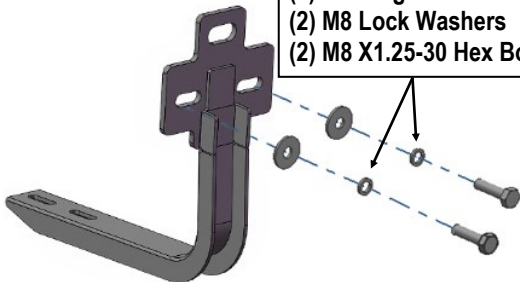

(Fig 11) Driver Center Mounting Bracket Installed to the Lower (2) Holes

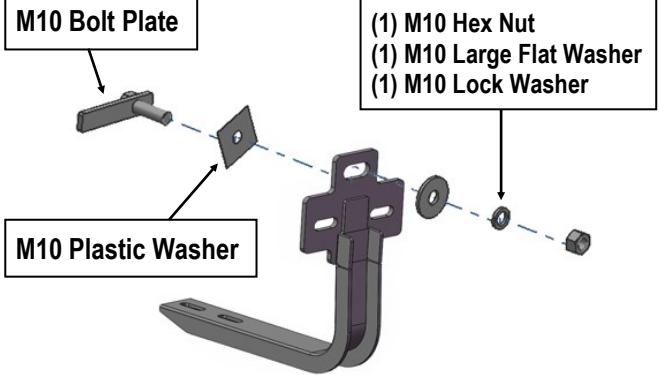

(Fig 12) Driver Center Mounting Bracket Attach to the Upper M10 Bolt Plate

STEP 4

Move to the Driver Side Rear Mounting Location. Repeat **Step 3** to install the Driver Rear Mounting Bracket.

STEP 5

Once all (3) mounting brackets are installed, then proceed to the Step Bar installation. According to the style of Step Bar proceed to the correct installation STEPS.

Note: Aluminum Step Bar refer to 6; Stainless Steel Step Bar skip to STEP 7.

STEP 6

Aluminum Step Bar Installation:

Select a **Aluminum Step Bar**. Slip (3) M6X1-20mm Square Head Bolts into each bottom channel (**Fig 13**). Carefully position the Step Bar onto the (3) Mounting Brackets.

IMPORTANT: Do not slide the Step Bar on the Brackets or the bottom surface of the board will be damaged. Attach the Step Bar to each Mounting Brackets with (2) M6X1-20mm Square Head Bolts, (2) M6 Large Flat Washers and (2) M6X1 Nylon Lock Nuts, (**Fig 14**). Do not fully tighten at this time.

Level and adjust the Step Bar and fully tighten all hardware.

Repeat **Steps 1-6** for the other side Step Bar installation. **The installation is completed!!!**



(Fig 13) Slip M6X1-20mm Square Head Bolts Into The Bottom Channels

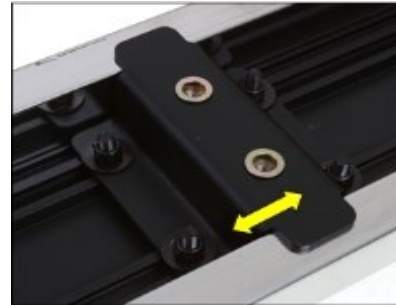

(Fig 15) Slide & line up the U-Slider with the installed mounting brackets along bottom channel

(2) M6X1-20mm Square Head Bolts
(2) M6 Large Flat Washers
(2) M6X1 Nylon Lock Nuts
IMPORTANT: TORQUE FOR 6MM FASTENERS MUST LESS THAN 6-7 FT-LBS OR THE FASTENERS WILL BE DAMAGED!

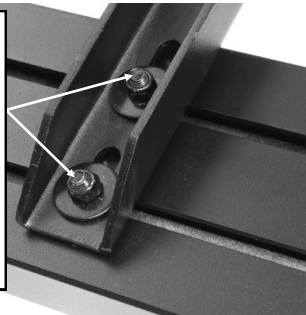

(Fig 14) Running Board Installed Onto Mounting Bracket

(2) M6X1-20mm Hex Bolts
(2) M6 Large Flat Washers
(2) M6 Lock Washers
IMPORTANT: TORQUE FOR 6MM FASTENERS MUST LESS THAN 6-7 FT-LBS OR THE FASTENERS WILL BE DAMAGED!

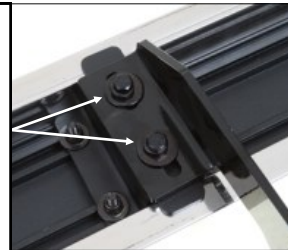

(Fig 16) Step Bar Installed on Bracket Installed (Example)

STEP 7

Stainless Steel Step Bar Installation:

Select a **Stainless Steel Step Bar** (with the U-Sliders installed on the Bar). Loose the U-Sliders, reposition the U-Sliders onto the board according to the (3) Installed Mounting Brackets location, (Fig 15). Re-secure the U-Sliders on the Step Bar. Attach the Step Bar to the installed Mounting Brackets with (6) M6X1-20mm Hex Bolts, (6) M6 Large Flat Washers & (6) M6 Lock Washers, (Fig 16). Do not fully tighten hardware at this time.

Level and adjust the Step Bar and fully tighten all hardware.

Repeat **Steps 1-5 and 7** for the other side Step Bar installation.

The installation is completed!!!

Attention

Do periodic inspections to the installation to make sure that all hardware is secure and tight.
In order to protect your bars/boards, please use mild soap/non-abrasive products for cleaning only.