

iBoard®



Scan for
Installation Video

iBoard® by APS

PART#: IB-004[L,S] C&H

READ INSTRUCTIONS CAREFULLY BEFORE STARTING INSTALLATION. REMOVE CONTENTS FROM BOX AND VERIFY ALL PARTS ARE PRESENT. ASSISTANCE IS RECOMMENDED.

*BODY FRAME MOUNT
*NO DRILLING REQUIRED

Fastener Size	Tightening Torque (ft-lbs)	Required
6mm	6-7	X
8mm	16-18	√
10mm	31-32	√
12mm	56-58	X
14mm	92-94	X

PART LIST

Driver Side Step Bar

Front

Passenger Side Step Bar

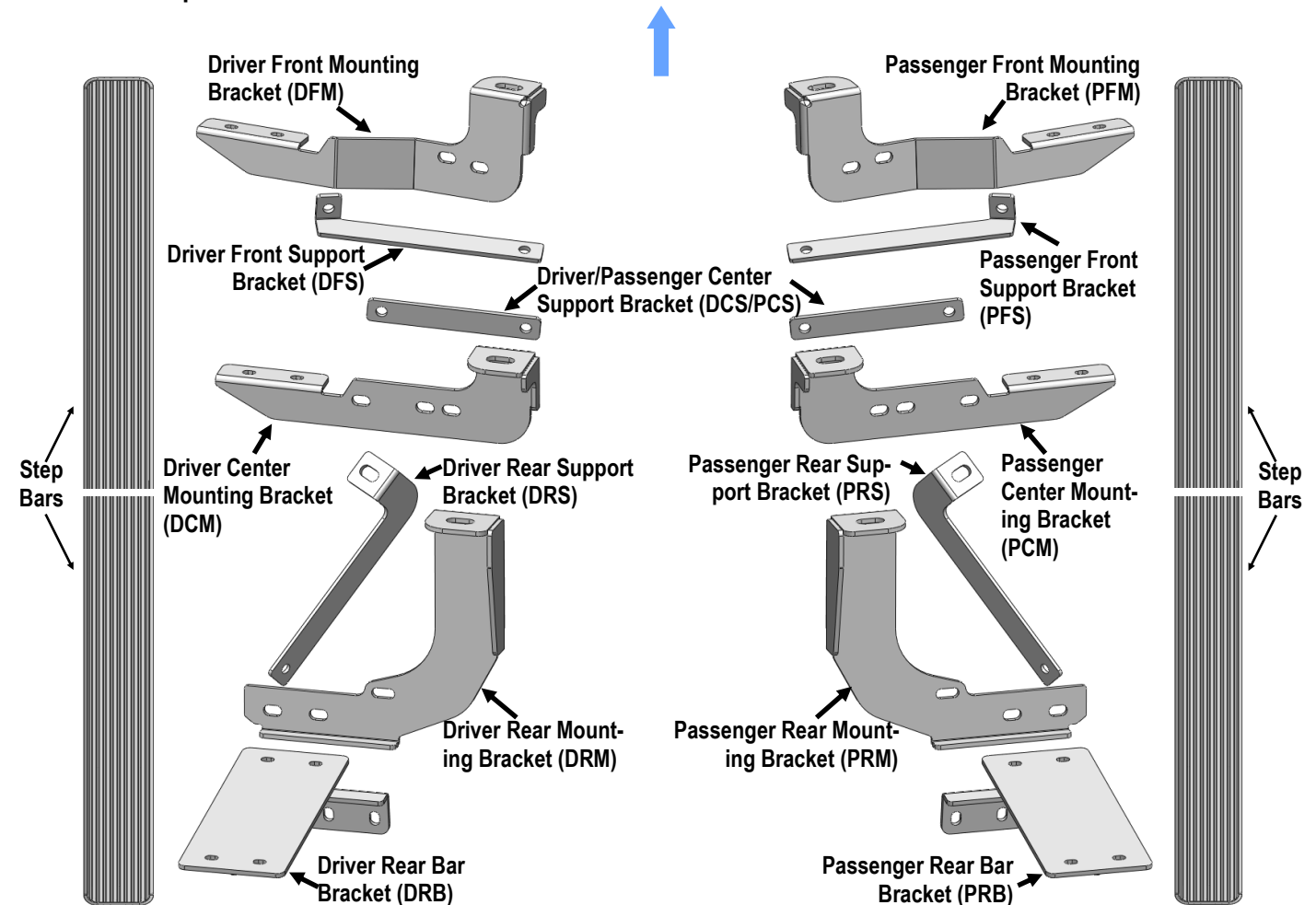







Customer Support: info@iboardauto.com





Hardware Package A (For Bracket Installation)

Item	QTY	Description	Item	QTY	Description
1#	2	M10 Nut Plates	5#	28	M10 Flat Washers
2#	2	M10X30 Bolt Plates	6#	16	M10 Lock Washers
3#	2	M10 Plastic Washers	7#	14	M10 Hex Nuts
4#	14	M10X1.5-30mm Hex Bolts			

						
1 #	2 #	3 #	4 #	5 #	6 #	7 #



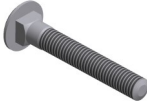

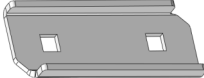
Hardware Package B (For Stainless Steel Step Bar Installation)

Item	QTY	Description	Item	QTY	Description
1#	16	M8X1.25-35mm Carriage Bolts	3#	16	M8 Nylon Lock Nuts
2#	16	M8 Large Flat Washers	4#	8	Sliders (Packed with Step Bars)

			
1 #	2 #	3 #	4 #

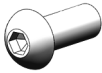
Hardware Package C (For Stainless Steel Step Bar Assembly)

Item	QTY	Description	Item	QTY	Description
1#	8	Plastic Rivets	5#	4	M8 Hex Nuts
2#	12	M8X1.25-25mm Inner Hex Bolts	6#	2	Plastic Covers (Packed with Step Bars)
3#	16	M8 Flat Washers	7#	2	Back Plates (Packed with Step Bars)
4#	12	M8 Lock Washers			

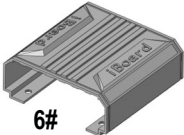
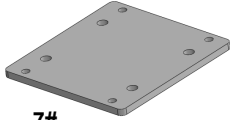
						
1 #	2 #	3 #	4 #	5 #	6 #	7 #



STEP 1

Step Bar Assembly:

1. Select and assemble (2) Step Bars with (2) M8X1.25-25mm Inner Hex Bolts, (4) M8 Flat Washers, (2) M8 Lock Washers and (2) M8 Hex Nuts, (Fig 1). **NOTE: (4) Step Bars are universal.**
2. Attach (1) Back Plate to the bottom of the installed (2) Step Bars with (4) M8X1.25-25mm Inner Hex Bolts, (4) M8 Flat Washers, (4) M8 Lock Washers, (Fig 2).
3. Install (1) Plastic Cover to cover the joint of (2) Step bars with (4) Plastic Rivets, (Fig 3).
4. Repeat to assemble the other (2) Step Bars.

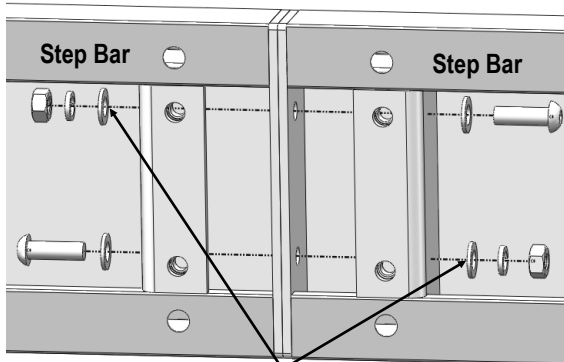

- (2) M8X1.25-25mm Inner Hex Bolts
- (4) M8 Flat Washers
- (2) M8 Lock Washers
- (2) M8 Hex Nuts

(Fig 1) Step Bars Assembly

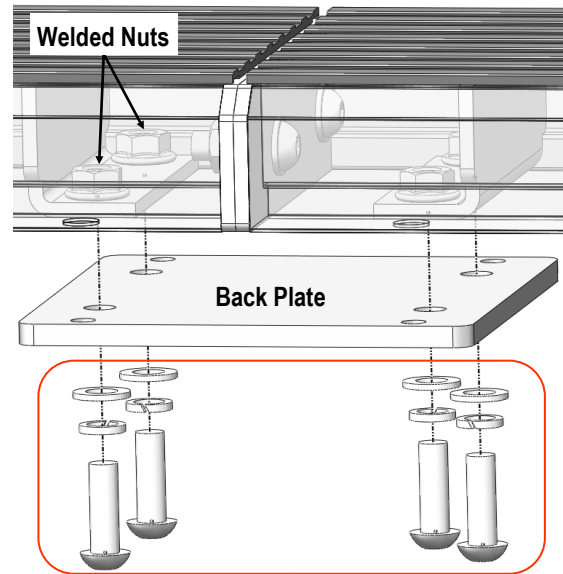

- (4) M8X1.25-25mm Inner Hex Bolts
- (4) M8 Flat Washers
- (4) M8 Lock Washers

(Fig 2) Back Plate Installation

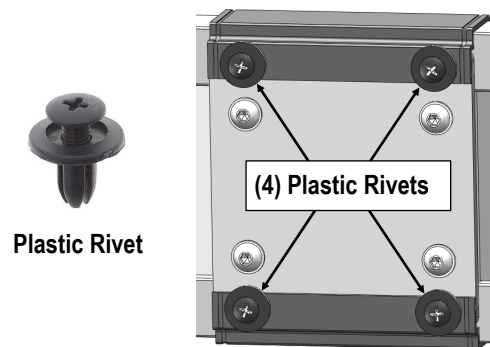

Plastic Rivet

(Fig 3) Plastic Cover Installation
(Bottom View)

Assembled Step Bars





STEP 2

Start the installation from the passenger side of the vehicle. Remove the front body mount bolt, (Fig 4). Do not remove rubber bushings.

STEP 3

Attach the Passenger Front Mounting Bracket (PFM) to the body mount reusing the factory hex bolt, (Figs 4 & 5). Do not tighten hardware at this time.

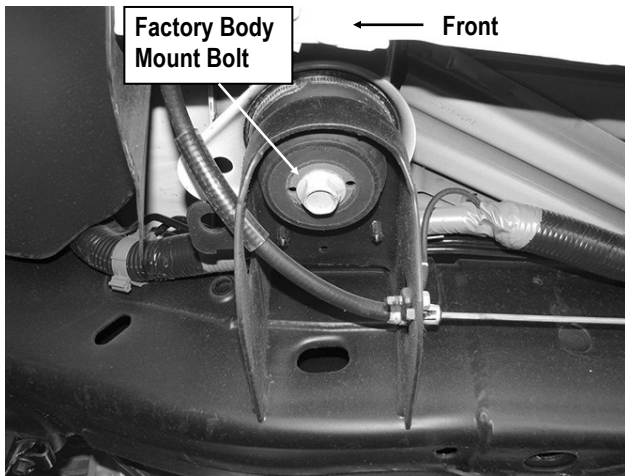

(Fig 4) Passenger Side Front Mounting Location

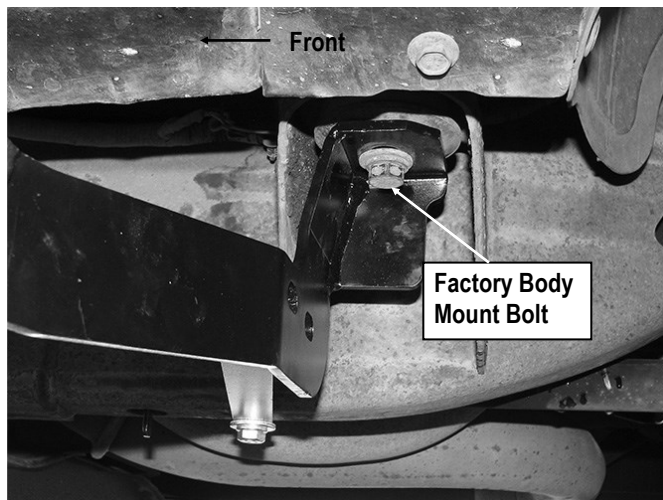

(Fig 5) Passenger Front Mounting Bracket Installed

STEP 4

Locate the (2) factory holes in the bottom of the frame towards the front of the vehicle, (Fig 6). Insert (1) M10 Nut Plate into the oval hole and line up the threaded nut with the forward round hole, (Fig 6).

NOTE: M10 Nut Plate and Support Brackets are not required on 2011-Up 2500/3500 models.

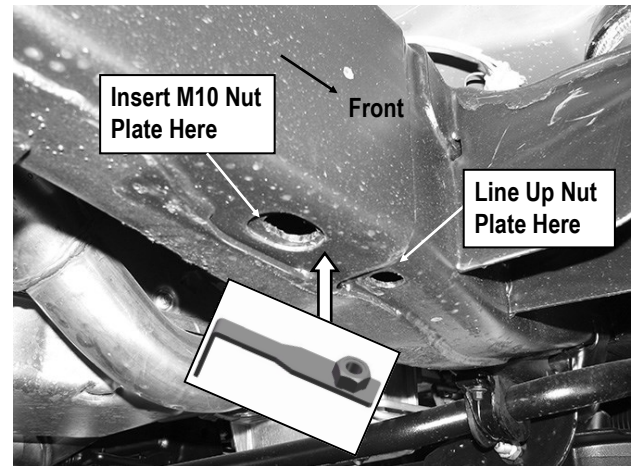

(Fig 6) Passenger Front Support Bracket Mounting Location

STEP 5

Attach the flat end of the Passenger Front Support Bracket (PFS) to the M10 Nut Plate with (1) M10X1.5-30mm Hex Bolt, (1) M10 Lock Washer and (1) M10 Flat Washer, (Figs 7 & 8). Do not fully tighten hardware at this time.

1500 Models:

Attach the bent end of the Support Bracket onto the Passenger Front Mounting Bracket with (1) M10X1.5-30mm Hex Bolt, (2) M10 Flat Washers, (1) M10 Lock Washer and (1) M10 Hex Nut, (Fig 7). Do not fully tighten hardware at this time.

Up to 2010 2500/3500 Models:

Note that the Front Support Bracket will not reach up to the Mounting Bracket, (Fig 8). Tighten the Support Bracket to the Nut Plate in the frame. Carefully push up on the Support Bracket until it reaches the inside hole in the Mounting Bracket. Bolt the Support Bracket to the hole in the Mounting Bracket with (1)



M10X1.5-30mm Hex Bolt, (2) M10 Flat Washers, (1) M10 Lock Washer and (1) M10 Hex Nut, (Fig 8). Do not fully tighten at this time.

Note: Support Bracket not required on 2011-Up 2500/3500 Models.

- (1) M10X1.5-30mm Hex Bolt
- (1) M10 Lock Washer
- (1) M10 Flat Washer

- (1) M10X1.5-30mm Hex Bolt
- (2) M10 Flat Washers
- (1) M10 Lock Washer
- (1) M10 Hex Nut

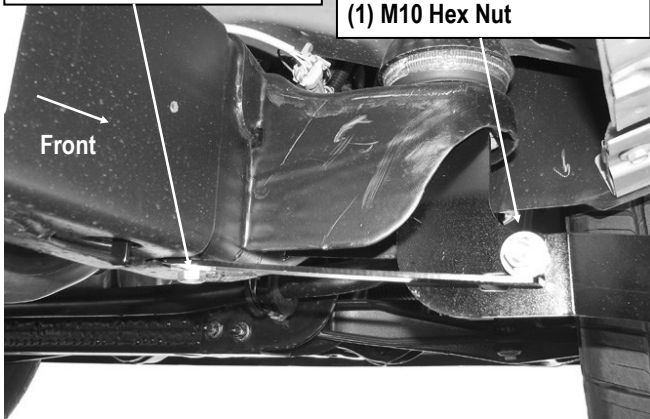

(Fig 7) Passenger Side Front Support Bracket Installed (1500 Models)

- (1) M10X1.5-30mm Hex Bolt
- (1) M10 Lock Washer
- (1) M10 Flat Washer

- (1) M10X1.5-30mm Hex Bolt
- (2) M10 Flat Washers
- (1) M10 Lock Washer
- (1) M10 Hex Nut

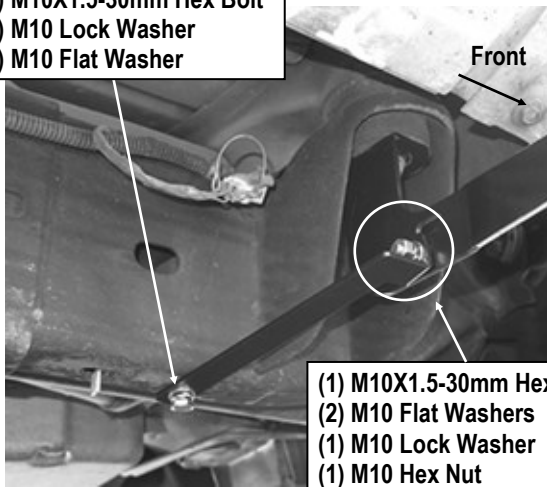

(Fig 8) Passenger Front Support Bracket Installed (Up to 2011 2500/3500 Models)

STEP 6

Move to the center body mount and remove the factory bolt. Select the Passenger Side Center Mounting Bracket. Repeat **Steps 2-3** to attach the Passenger Center Mounting Bracket.

Next, select (1) Passenger Center Support Bracket. Note the two different sizes of mounting holes in the Support Bracket. Slide the end of the Center Support Bracket with the larger mounting hole between the factory body mount and the center Bracket, (Figs 9 & 10). Attach the Support Bracket to the holes in the side of the body mount and the mounting bracket with (2) M10X1.5-30mm Hex Bolts, (2) M10 Large Flat Washers, (2) M10 Flat Washers, (2) M10 Lock Washers and (2) M10 Hex Nuts. Do not fully tighten at this time.

IMPORTANT: Center Support Brackets are not required on 2011—Up 2500/3500 Models.

- (1) M10X1.5-30mm Hex Bolt
- (2) M10 Flat Washers
- (1) M10 Lock Washer
- (1) M10 Hex Nut

- (1) M10X1.5-30mm Hex Bolt
- (2) M10 Flat Washers
- (1) M10 Lock Washer
- (1) M10 Hex Nut



(Fig 9) Passenger Side Center Bracket Installed (1500 Models)

- (1) M10X1.5-30mm Hex Bolt
- (2) M10 Flat Washers
- (1) M10 Lock Washer
- (1) M10 Hex Nut

- (1) M10X1.5-30mm Hex Bolt
- (2) M10 Flat Washers
- (1) M10 Lock Washer
- (1) M10 Hex Nut



(Fig 10) Passenger Center Bracket Installed (Up to 2011 2500/3500 Models)



STEP 7

Move to the passenger side rear location. Assemble (1) Passenger Rear Mounting Bracket (**PRM**) and (1) Passenger Rear Bar Bracket (**PRB**) with (2) M10X1.5-30mm Hex Bolts, (2) M10 Lock Washers, (4) M10 Flat Washers and (2) M10 Hex Nuts, (**Fig 11**). Do not fully tighten hardware at this time.

Repeat **Steps 1-2** to install the assembled Passenger Rear Bracket, (**Fig 12**).

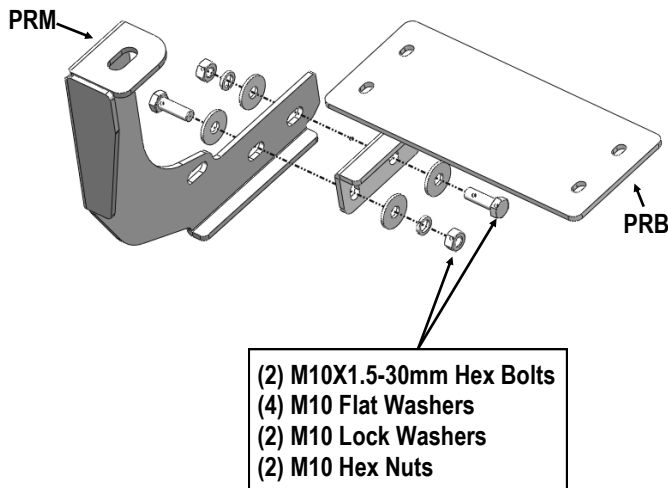

(Fig 11) Passenger Rear Brackets Assembly

Factory Body
Mount Bolt

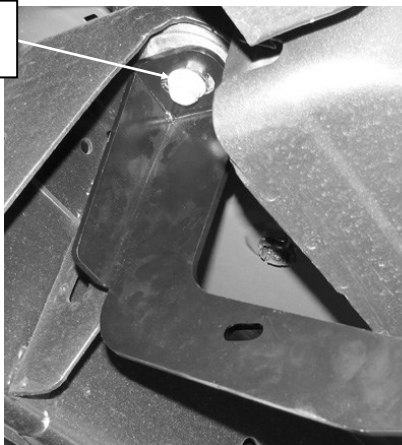

(Fig 12) Passenger Side Rear Bracket Installed

STEP 8

Locate the factory hole in the side of the body panel towards the rear of the vehicle. Remove the rubber plug, (**Fig 13**). Thread (1) M10 Plastic Washer part way onto (1) M10X30 Bolt Plate. Insert the Bolt Plate into the hole and thread the Plastic Washer down until it is tight against the body panel, (**Fig 14**). **IMPORTANT:** The Plastic Washer is designed to prevent the Bolt Plate from falling into the body cavity and to aid in installing the Support Bracket.

Attach the Passenger Rear Support Bracket (**PRS**) to the Bolt Plate with (1) M10 Flat Washer, (1) M10 Lock Washer and (1) M10 Hex Nut, (**Fig 15**). Bolt the lower end of the Support Bracket to the front of the Rear Mounting Bracket with (1) M10X1.5-30mm Hex Bolt, (2) M10 Flat Washers, (1) M10 Lock Washer and (1) M10 Hex Nut, (**Fig 16**). Do not fully tighten at this time.

Remove Factory
Plug If Equipped

Rear



(Fig 13) Passenger Side Rear Support Bracket Location

M10X30 Bolt Plate
M10 Plastic Washer

Rear

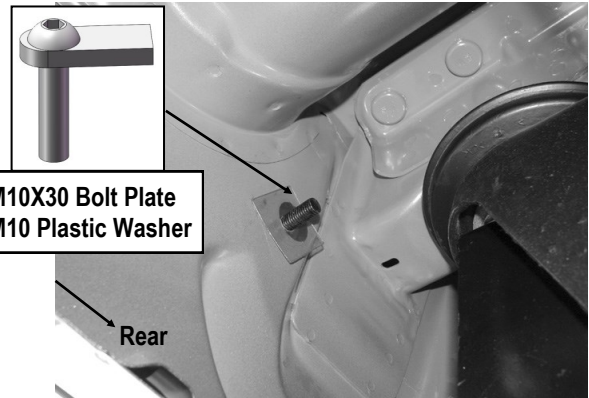

(Fig 14) Insert The M10X30 Bolt Plate



- (1) M10X30 Bolt Plate
- (1) M10 Plastic Washer
- (1) M10 Flat Washer
- (1) M10 Lock Washer
- (1) M10 Hex Nut

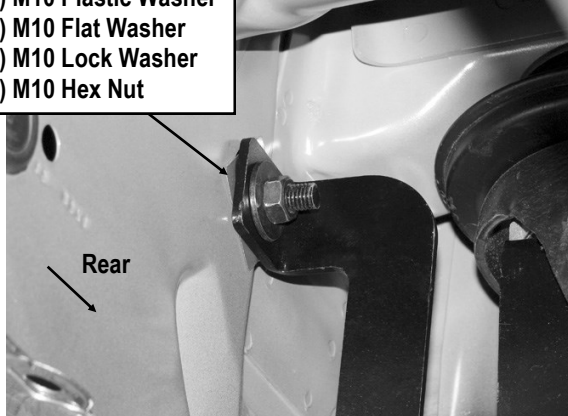

(Fig 15) Passenger Side Rear Support Bracket Installation

- (1) M10X1.5-30mm Hex Bolt
- (2) M10 Flat Washers
- (1) M10 Lock Washer
- (1) M10 Hex Nut

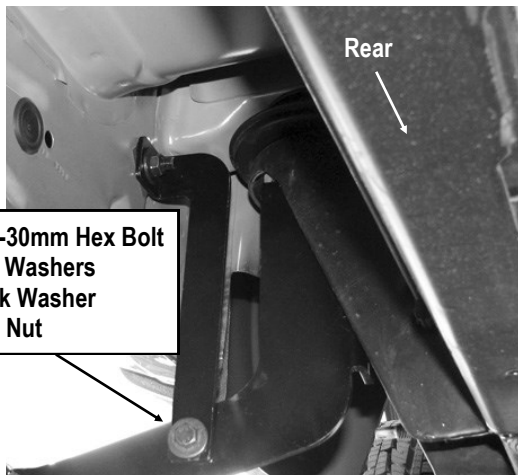

(Fig 16) Passenger Side Rear Support Bracket Assembly

(5) Attach the Step Bar (with the Sliders) onto the installed mounting brackets. Position the Sliders to the installed brackets. Secure the Step Bar to the installed Brackets by using (8) M8 Large Flat Washers and (8) M8 Nylon Lock Nuts and (4) Sliders, (Fig 18). Do not fully tighten hardware at this time.

Note: The Sliders are packed with the Step Bars.

Level and adjust the Step Bar and fully tighten all hardware.

Repeat **Steps 2-9** for the other side Step Bar installation. **The installation is completed!!!**

Attention

Do periodic inspections to the installation to make sure that all hardware is secure and tight.

In order to protect your bars/boards, please use mild soap/non-abrasive products for cleaning only.

STEP 9

Once all (3) Passenger side mounting brackets are installed, then proceed to the Step Bar installation. (Figs 17 & 18)

- (1) Select (1) Slider and (2) M8X1.25-35mm Carriage Bolts;
- (2) Install (2) M8X1.25-35mm Carriage Bolts in (1) Slider.
- (3) Slide the Slider (with carriage bolts) to the **Step Bar**.
- (4) Repeat to install the other (2) sliders to the step bar.

