

# iRunning Board Installation Instruction

Application: For 2015-2019 Chevrolet Colorado Extended Cab /2015-2019 GMC Canyon Extended Cab 6' Bed

Rev:20190601

## PARTS LIST:

Item	QTY	Description	Item	QTY	Description
#1	2	Running Board(use for left or right)	#7	6	U-Slider
#2	6	Mounting Brackets	#8	24	M6 Nylon Lock Nuts
#3	12	M8 Clip Nuts	#9	12	M6 Large Flat Washers
#4	12	M8X1.25-25mm Hex Bolts	#10	12	M6 Lock Washers
#5	12	M8 Flat Washers	#11	24	M6 Flat Washers
#6	12	M8 Lock Washers	#12	12	M6X1-20 Hex Bolts

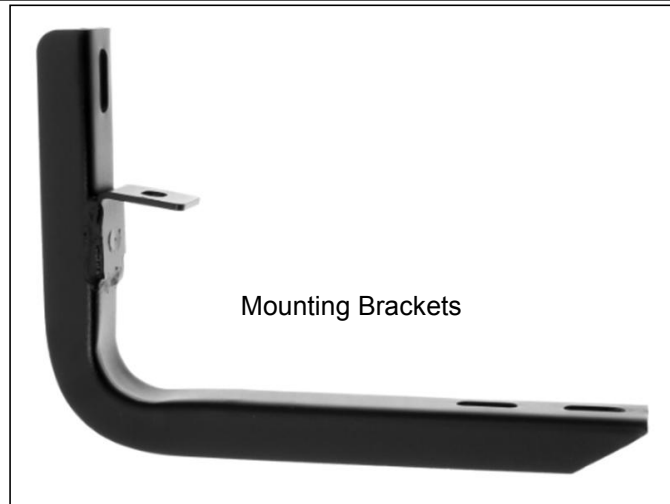

**IMPORTANT ALERT: FOR WHEEL TO WHEEL APPLICATION, WEIGHT TO THE REAR END AREA OF THE RUNNING BOARD BEHIDE THE LAST BRACKET NEED TO LESS THEN 130KG.OVERWEIGHT IN THIS AREA MAYBE DAMAGE YOUR RUNNING BOARD.**

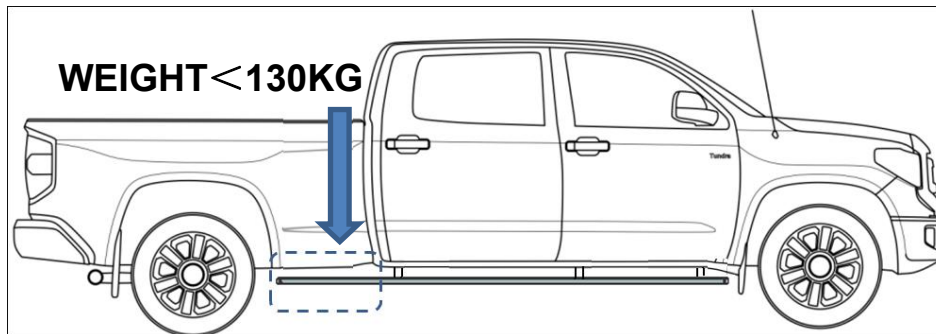

## PROCEDURE:

- 1. REMOVE CONTENTS FROM BOX. VERIFY ALL PARTS ARE PRESENT. READ INSTRUCTIONS CAREFULLY BEFORE STARTING INSTALLATION. ASSISTANCE IS RECOMMENDED.**
2. Start the installation under the passenger side of the vehicle. Locate the 4 factory running board mounting locations along the bottom and inner side of the body, **(Figure 1)**. Mounting Brackets will bolt to the 1st, 2nd and 4th mounting locations.
3. Remove rubber plugs as necessary from the holes in the side and bottom of the inner body panel, **(Figure 2)**. Select (1) M8 Clip Nut. Slide the Clip Nut into the large hole and over the smaller hole next to it in the side of the body panel. Line up threaded nut on the Clip Nut with smaller hole in body panel, **(Figure 3)**. Repeat to install a Clip Nut in the bottom mounting location.
4. Select (1) driver side Mounting Bracket. Bolt the Mounting Bracket to the (2) Clip Nuts with (2) M8 Hex Bolts, (2) M8 Lock Washers and (2) M8 Flat Washers, **(Figure 4)**. Snug but do not fully tighten the hardware.
5. Repeat **Steps 2- 4** to install center and rear position brackets.

## iRunning Board Installation Instruction

Application: For 2015-2019 Chevrolet Colorado Extended Cab /2015-2019 GMC Canyon Extended Cab 6' Bed

Rev:20190601

- Once all (3) Brackets have been installed, select a Running Board. Attach the U-Slider as shown(**Figure 5**). Do not tighten the (4)M6 hex nuts at this time, slide the U-Slider onto the position of Mounting Brackets along bottom channel (**Figure 5**). **NOTE: The middle slider is fixed. Do not loose(Figure 6)**. Carefully position the Running Board onto the Mounting Brackets. Attach the Running Board to the Mounting Brackets with (2) M6X1-20 hex bolts,(2)M6 large flat washers and (2)M6 lock washers, (**Figure 7**). Do not tighten hardware at this time.
- Level and adjust Running Board properly and tighten all hardware. **NOTE: Torque all M6 nylon lock nuts to 7 lb-ft.**
- Repeat **Steps 2—7** for passenger/right Running Board installation.
- Do periodic inspections to the installation to make sure that all hardware is secure and tight.

**To protect your investment**, wax this product after installing. Regular waxing is recommended to add a protective layer over the finish. Do not use any type of polish or wax that may contain abrasives that could damage the finish.

**For Polished Finishes:** Aluminum polish may be used to polish small scratches and scuffs on the finish. Mild soap may be used also to clean the Running Board.

**For Black Finishes:** Mild soap may be used to clean the Running Board.

### Passenger/right Side Installation Pictured

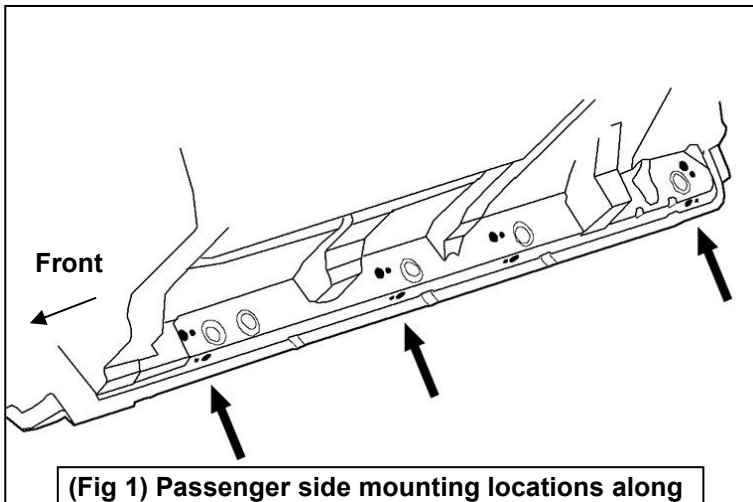

(Fig 1) Passenger side mounting locations along bottom and back of body panel illustrated

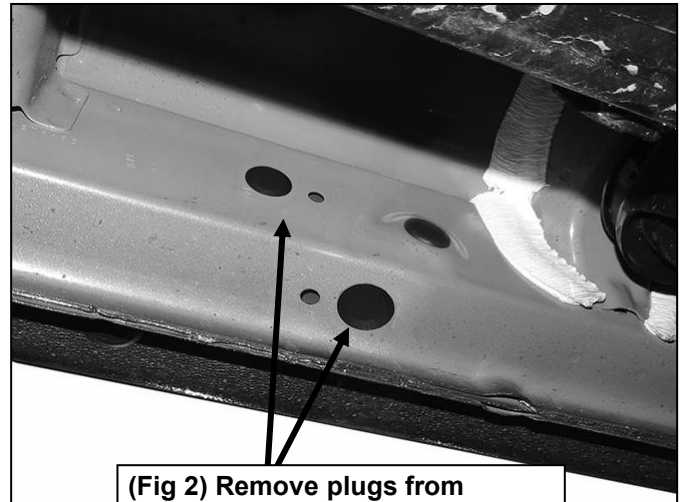

(Fig 2) Remove plugs from mounting locations as necessary

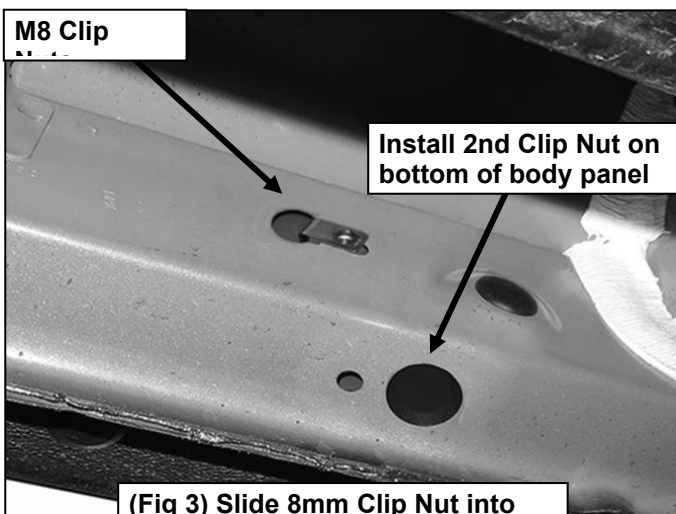

(Fig 3) Slide 8mm Clip Nut into large hole and over small hole

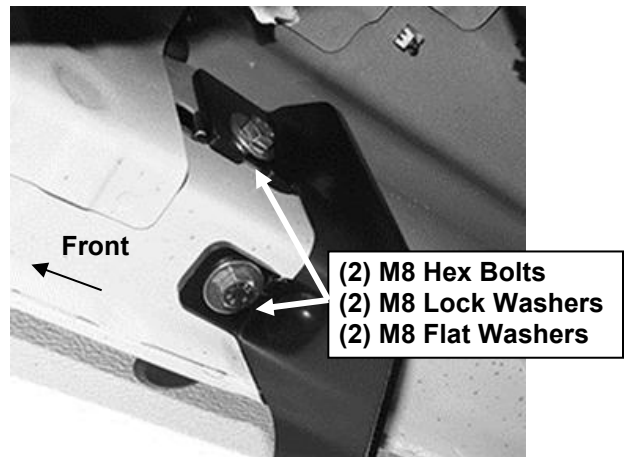

(Fig 4) Passenger side front Bracket installation(example only)

## iRunning Board Installation Instruction

Application: For 2015-2019 Chevrolet Colorado Extended Cab /2015-2019 GMC Canyon Extended Cab 6' Bed

Rev:20190601

- (4) M6 Hex Nuts
- (4) M6 Flat Washers
- (4) M6 T-Bolts(factory installed)

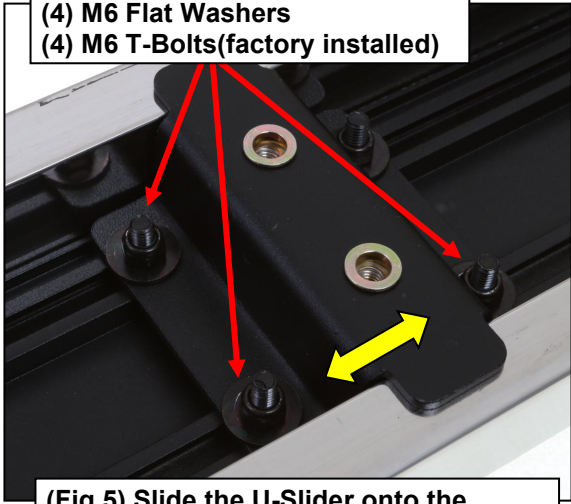

(Fig 5) Slide the U-Slider onto the position of Mounting Brackets along bottom channel.

The middle slider

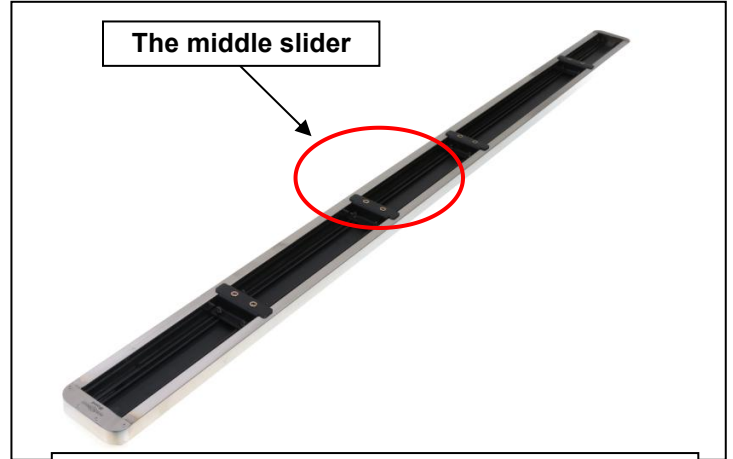

(Fig 6) The middle slider is fixed. Do not loose.

- (2)M6X1-20 Hex Bolts
- (2)M6 Large Flat Washers
- (2)M6 Lock Washers



(Fig 7) Bracket Installation