

iBoard®



Scan for
Installation Video

iBoard® by APS

PART#: IB-P197/P198C&J

READ INSTRUCTIONS CAREFULLY BEFORE STARTING INSTALLATION. REMOVE CONTENTS FROM BOX AND VERIFY ALL PARTS ARE PRESENT. ASSISTANCE IS RECOMMENDED.

*ROCKER PANEL MOUNT
*NO DRILLING REQUIRED

Fastener Size	Tightening Torque (ft-lbs)	Required
6mm	6-7	X
8mm	16-18	√
10mm	31-32	X
12mm	56-58	X
14mm	92-94	X

PART LIST

Driver Side Step Bar

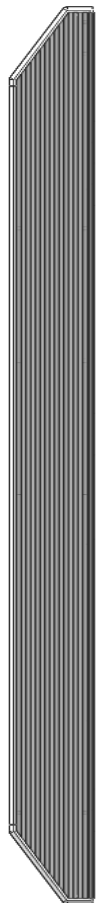

Driver Front/Center
Mounting Bracket
(DFM/DCM)

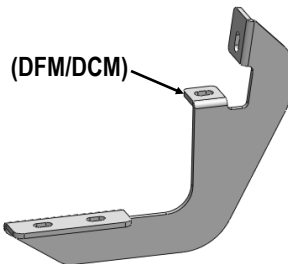
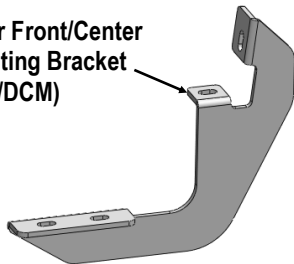

(DFM/DCM)

Driver Rear
Mounting Bracket
(DRM)

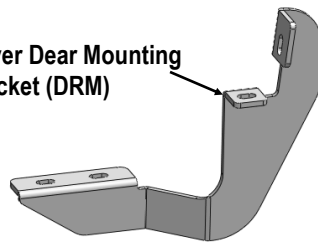

Front



Passenger Side Step Bar



Passenger Front/
Center Mounting
Bracket (PFM/PCM)

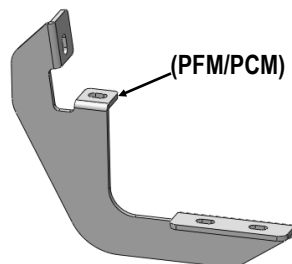
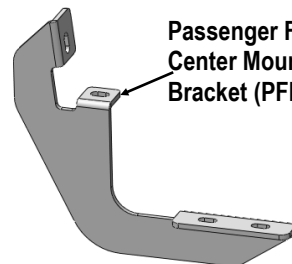

(PFM/PCM)

Passenger Rear
Mounting Bracket
(PRM)

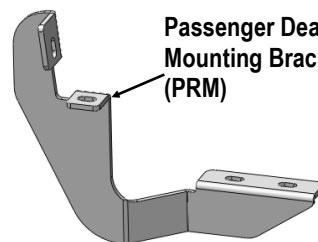

Customer Support: info@iboardauto.com



Hardware Package A (For Bracket Installation)

Item	QTY	Description	Item	QTY	Description
1#	12	M8X1.25-30mm Hex Bolts	3#	12	M8 Lock Washers
2#	12	M8 Large Flat Washers	4#	12	M8 Clip Nuts



1 #



2#



3#

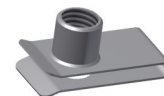

4#

Hardware Package B (For Step Bar Installation)

Item	QTY	Description	Item	QTY	Description
1#	12	M8X1.25-35mm Carriage Bolts	3#	12	M8 Nylon Lock Nuts
2#	12	M8 Large Flat Washers	4#	6	Sliders (Packed with Mounting Brackets)

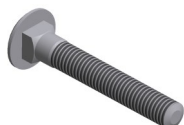

1 #



2 #

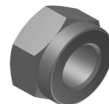

3 #



4 #



STEP 1

Start installation from the driver side front of the vehicle. If equipped, remove the plastic covers from the mounting locations on rocker panel, (Fig 1).

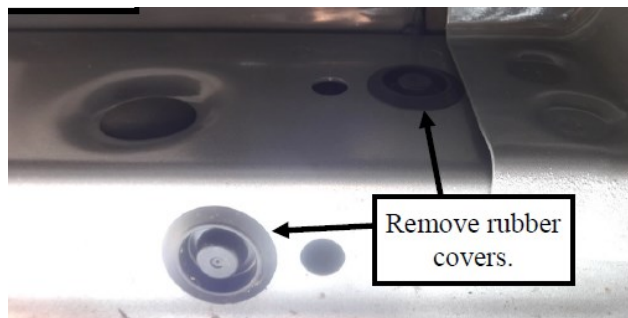

(Fig 1) Driver Side Front Mounting Location

STEP 2

Install the M8 Clip Nuts in the holes where the plastic covers were removed, (Fig 2).

Select the Driver Front Mounting Bracket, attach the Bracket to the vehicle by using the included (2) M8x1.25-30mm Hex Bolts, (2) M8 Lock Washers and (2) M8 Large Flat Washers, (Fig 3). Do not fully tighten hardware at this time.

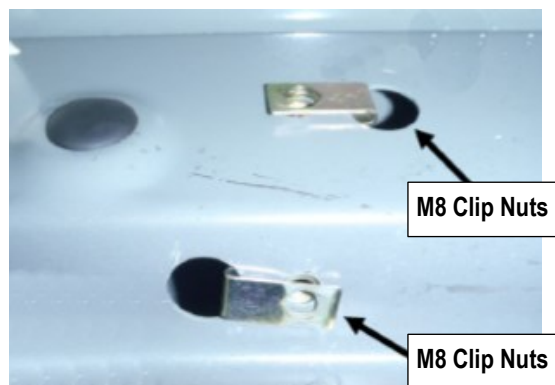

(Fig 2) Supplied M8 Clip Nuts Installed

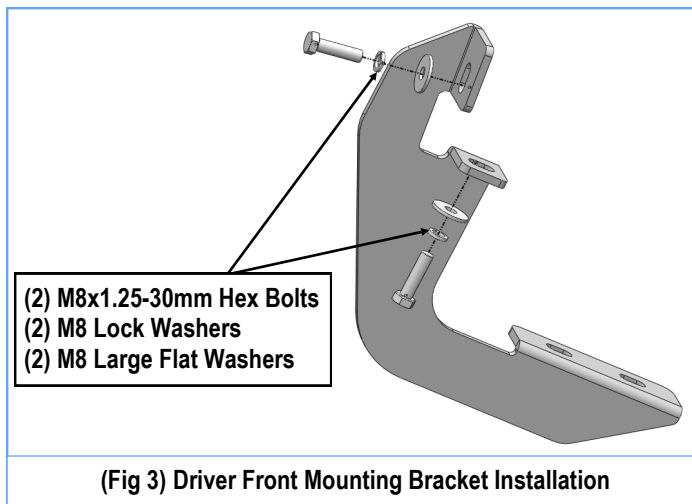

(Fig 3) Driver Front Mounting Bracket Installation

STEP 3

Move to the driver side center and rear mounting locations. Repeat **Steps 1 & 2** to install the Driver Center & Rear Mounting Brackets.

STEP 4

Once all (3) Driver side mounting brackets are assembled, then proceed to the Step Bar installation. (Figs 4 & 5)

- (1) Select (1) Slider and (2) M8X1.25-35mm Carriage Bolts;
- (2) Install (2) M8X1.25-35mm Carriage Bolts in (1) Slider.
- (3) Slide the Slider (with carriage bolts) to the **Step Bar**.
- (4) Repeat to install the other (2) sliders to the step bar.
- (5) Attach the Step Bar (with the Sliders) onto the installed mounting brackets. Position the Sliders to the installed brackets. Secure the Step Bar to the installed Brackets by using (6) M8 Large Flat Washers and (6) M8 Nylon Lock Nuts and (3) Sliders, (Fig 5). Do not fully tighten hardware.

Note: The Sliders are packed with the Mounting Brackets.

Level and adjust the Step Bar and fully tighten all hardware.

Repeat **Steps 1-4** for the other side Step Bar installation. **The installation is completed!!!**

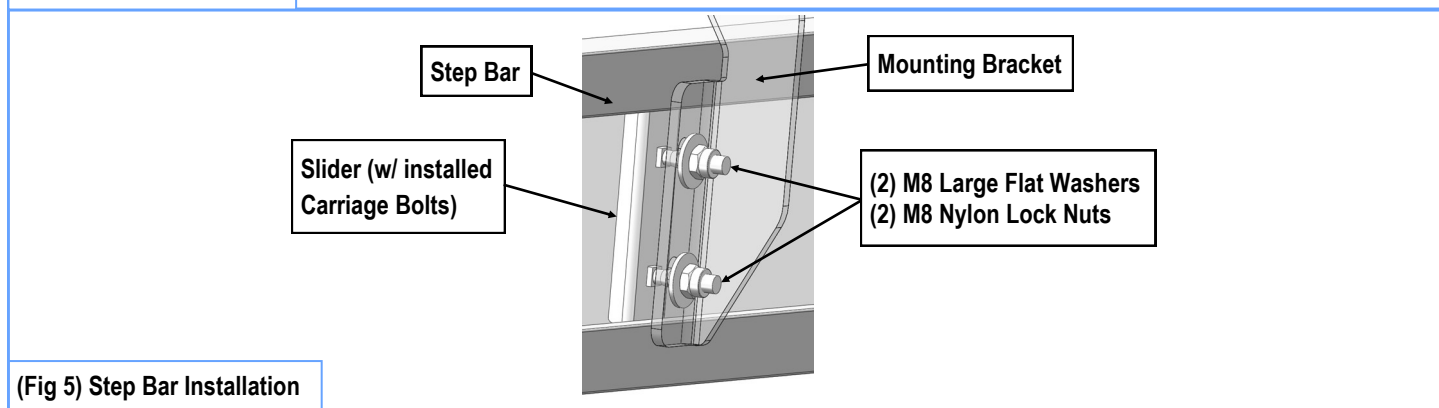
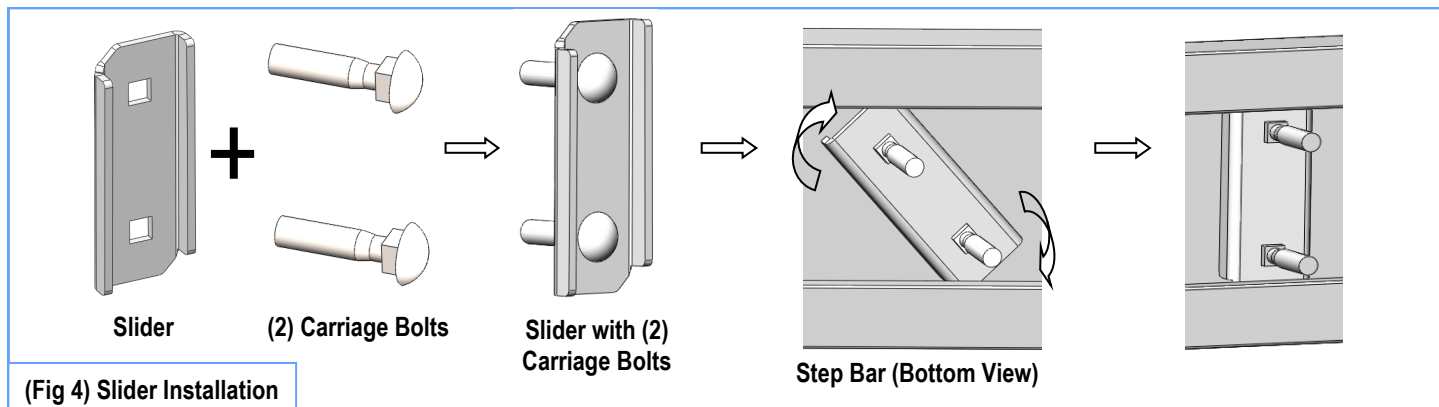

Attention

Do periodic inspections to the installation to make sure that all hardware is secure and tight.
In order to protect your bars/boards, please use mild soap/non-abrasive products for cleaning only.