

iBoard®



Scan for
Installation Video

iBoard® by APS

PART#: IB-P171C&J

READ INSTRUCTIONS CAREFULLY BEFORE STARTING INSTALLATION. REMOVE CONTENTS FROM BOX AND VERIFY ALL PARTS ARE PRESENT. ASSISTANCE IS RECOMMENDED.

*ROCKER PANEL MOUNT
*NO DRILLING REQUIRED

Fastener Size	Tightening Torque (ft-lbs)	Required
6mm	6-7	X
8mm	16-18	√
10mm	31-32	X
12mm	56-58	X
14mm	92-94	X

PART LIST

Driver Side Step Bar

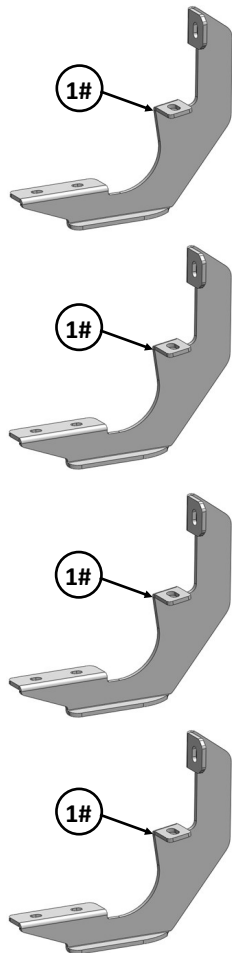
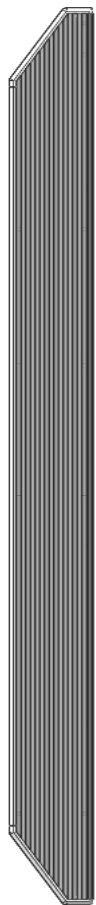

Front



Passenger Side Step Bar

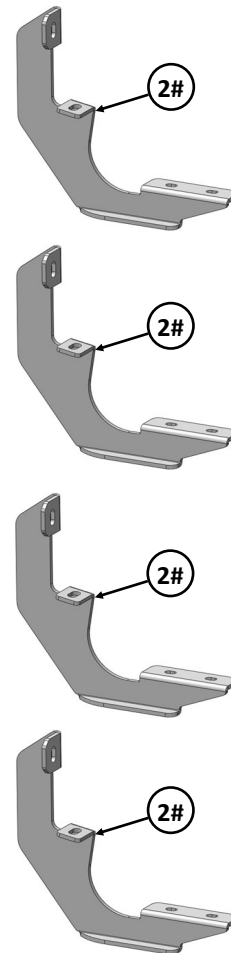

Customer Support: info@iboardauto.com



Hardware Package A (For Bracket Installation)

Item	QTY	Description	Item	QTY	Description
1#	4	Driver Side Mounting Brackets	4#	16	M8 Large Flat Washers
2#	4	Passenger Side Mounting Brackets	5#	16	M8 Lock Washers
3#	16	M8X1.25-30mm Hex Bolts			



3#



4#



5#

Hardware Package B (For Step Bar Installation)

Item	QTY	Description	Item	QTY	Description
1#	16	M8X1.25-35mm Carriage Bolts	3#	16	M8 Nylon Lock Nuts
2#	16	M8 Large Flat Washers	4#	8	Sliders (Packed with Mounting Brackets)

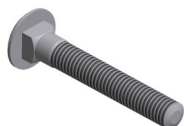

1 #



2 #



3 #



4 #



STEP 1

Start the installation under the passenger side of the vehicle. Locate the 6 plugs along the bottom edge of the body. Mounting Brackets will bolt to the 1st, 3rd, 4th and 6th threaded mounting holes, (**Fig 1**). Remove the plastic plugs from each mounting location. Directly above each threaded insert is a top mounting location on the side of the body panel. Hold a Bracket up in place to help determine the mounting holes to use along the body.

NOTE: Thread an 8mm Hex Bolt into the threaded inserts to clear paint as required.

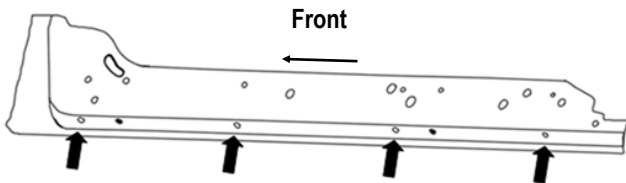

(Fig 1) Passenger Side Mounting Location

STEP 2

Start from the Passenger Side Front Mounting location, (**Fig 2**). Bolt the Passenger Front Mounting Bracket to the factory threaded holes with (2) M8X1.25-30mm Hex Bolts, (2) M8 Large Flat Washers and (2) M8 Lock Washers (**Fig 3**). Don't fully tighten hardware at this time.

Note: (4) Passenger Side Mounting Brackets are universal.

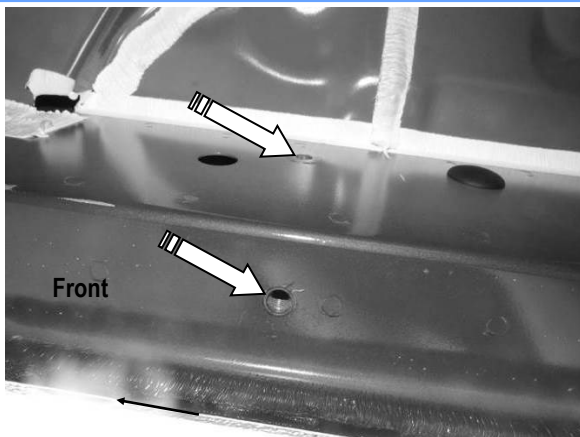

(Fig 2) Passenger Side Front Mounting Location

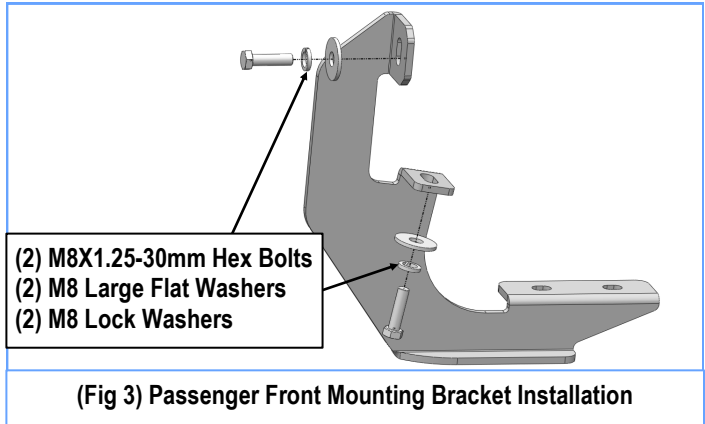

(Fig 3) Passenger Front Mounting Bracket Installation

STEP 3

Move to Passenger 2nd, 3rd and rear Mounting locations, (**Fig 4-6**). Repeat **Step 2** to install the Passenger Center Mounting Bracket, Passenger Center 1 Mounting Bracket and Passenger Rear Mounting Bracket. Don't fully tighten at this time.

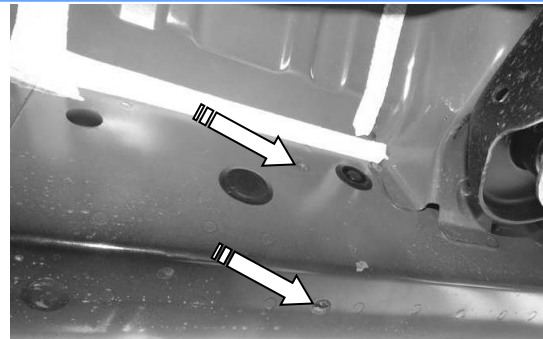

(Fig 4) Passenger 2nd Mounting Bracket Location

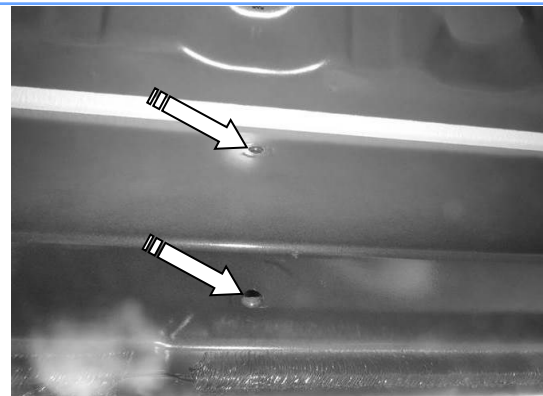

(Fig 5) Passenger 3rd Mounting Bracket Location

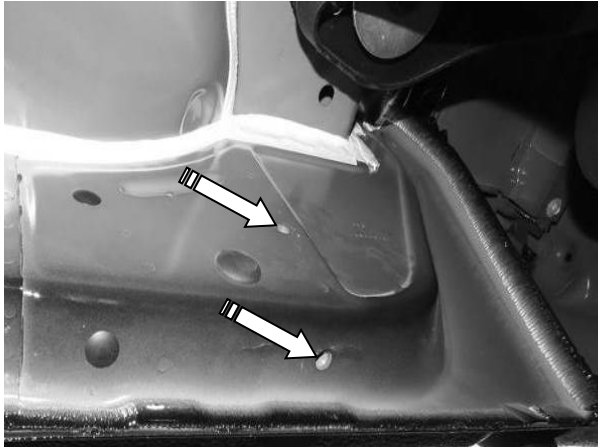

(Fig 6) Passenger Rear Mounting Bracket Location

Attention

Do periodic inspections to the installation to make sure that all hardware is secure and tight.

In order to protect your bars/boards, please use mild soap/non-abrasive products for cleaning only.

STEP 4

Once all (4) Passenger side mounting brackets are installed, then proceed to the Step Bar installation. (Figs 7 & 8)

- (1) Select (1) Slider and (2) M8X1.25-35mm Carriage Bolts;
- (2) Install (2) M8X1.25-35mm Carriage Bolts in (1) Slider.
- (3) Slide the Slider (with carriage bolts) to the **Step Bar**.
- (4) Repeat to install the other (3) sliders to the step bar.
- (5) Attach the Step Bar (with the Sliders) onto the installed mounting brackets. Position the Sliders to the installed brackets. Secure the Step Bar to the installed Brackets by using (8) M8 Large Flat Washers and (8) M8 Nylon Lock Nuts and (4) Sliders, (Fig 8). Do not fully tighten hardware at this time.

Note: The Sliders are packed with the Mounting Bracket.

Level and adjust the Step Bar and fully tighten all hardware.

Repeat **Steps 1-4** for the other side Step Bar installation. **The installation is completed!!!**

