

iBoard®

iBoard® by APS

PART#: IB-004

READ INSTRUCTIONS CAREFULLY BEFORE STARTING INSTALLATION. REMOVE CONTENTS FROM BOX AND VERIFY ALL PARTS ARE PRESENT. ASSISTANCE IS RECOMMENDED.

*ROCKER PANEL MOUNT
*NO DRILLING REQUIRED

Fastener Size	Tightening Torque (ft-lbs)	Required
6mm	6-7	√
8mm	16-18	X
10mm	31-32	√
12mm	56-58	X
14mm	92-94	X

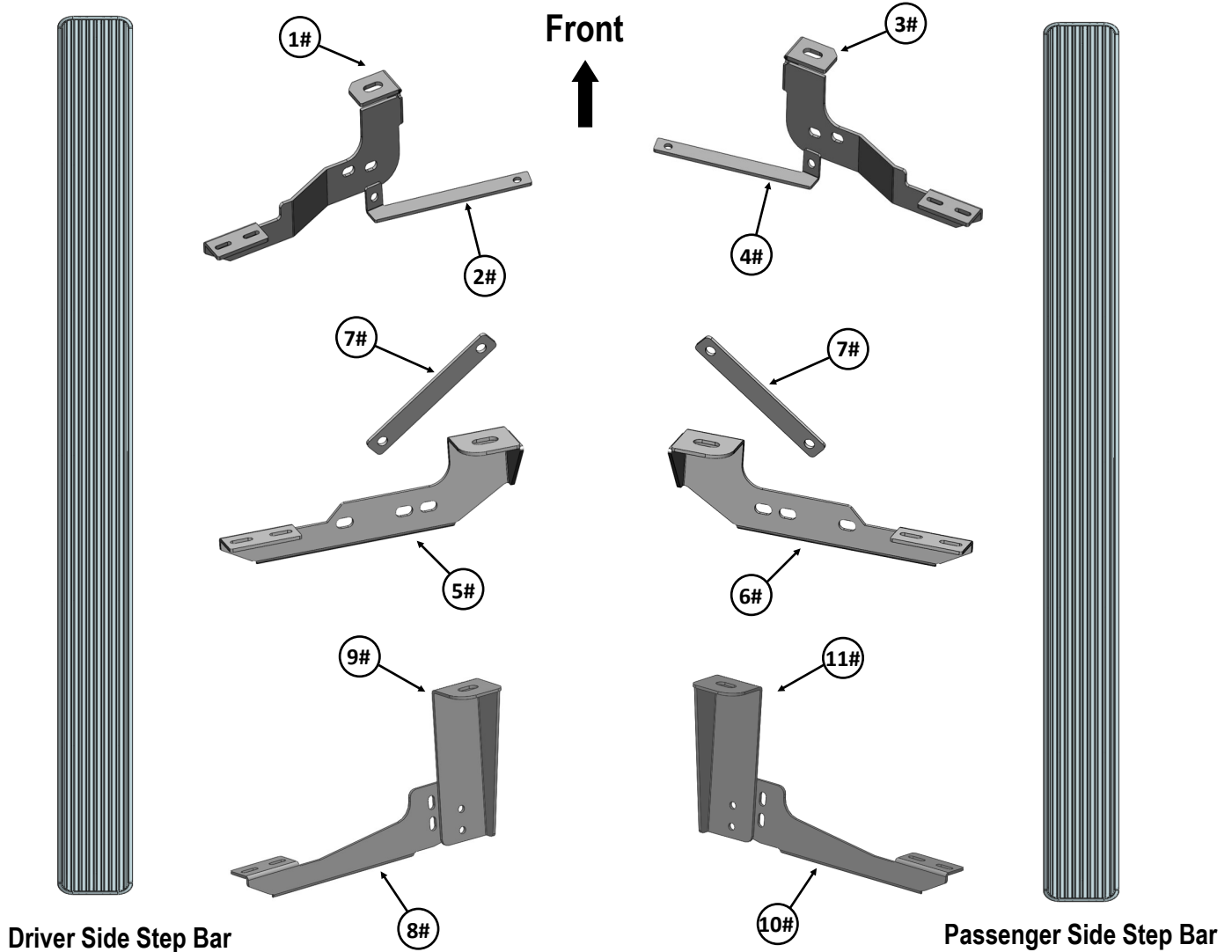

Customer Support: info@iboardauto.com

iBoard®

Mounting Bracket List					
Item	QTY	Description	Item	QTY	Description
1#	1	Driver Front Mounting Bracket	7#	2	Driver/Passenger Center Support Brackets
2#	1	Driver Front Support Bracket	8#	1	Driver Rear Bar Bracket
3#	1	Passenger Front Mounting Bracket	9#	1	Driver Rear Mounting Bracket
4#	1	Passenger Front Support Bracket	10#	1	Passenger Rear Bar Bracket
5#	1	Driver Center Mounting Bracket	11#	1	Passenger Rear Mounting Bracket
6#	1	Passenger Center Mounting Bracket			

Hardware Package A (For Bracket Installation)					
Item	QTY	Description	Item	QTY	Description
1#	2	M10 Nut Plates	4#	18	M10 Flat Washers
2#	12	M10X1.5-30mm Hex Bolts	5#	12	M10 Lock Washers
3#	4	M10 Large Flat Washers	6#	10	M10 Hex Nuts



1#



2#



3#



4#



5#



6#

Hardware Package B (For Aluminum Step Bar Installation Only, Not Supply to SS. Step Bar)					
Item	QTY	Description	Item	QTY	Description
1#	12	M6X1-20mm Square Head Bolts	3#	12	M6 Nylon Lock Nuts
2#	12	M6 Large Flat Washers			

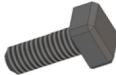

1 #



2 #



3 #

Hardware Package C (For Stainless Steel Step Bar Installation Only, Not Supply to Aluminum Step Bar)					
Item	QTY	Description	Item	QTY	Description
1#	12	M6X1-20mm Hex Bolts	3#	12	M6 Flat Washers
2#	12	M6 Lock Washers			



1 #



2 #



3 #

iBoard®

STEP 1

Start the installation under the Passenger side of the vehicle. Remove the front body mount bolt, **(Fig 1)**. Do not remove rubber bushings.

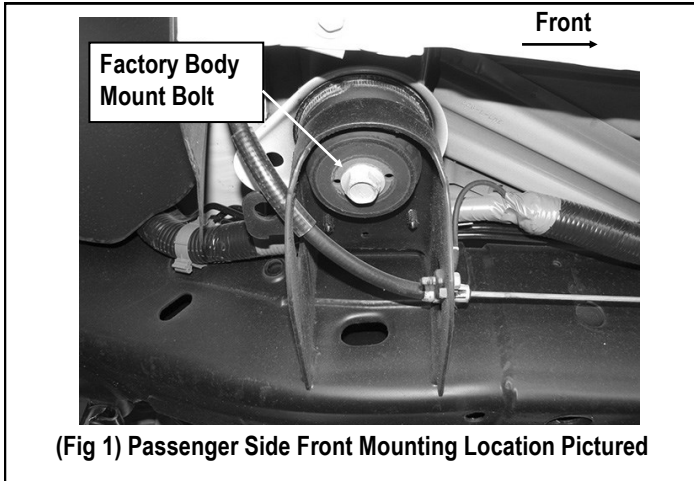

(Fig 1) Passenger Side Front Mounting Location Pictured

STEP 2

Attach the Passenger Front Mounting Bracket to the body mount reusing the factory hex bolt, **(Fig 2)**. Do not tighten hardware at this time.

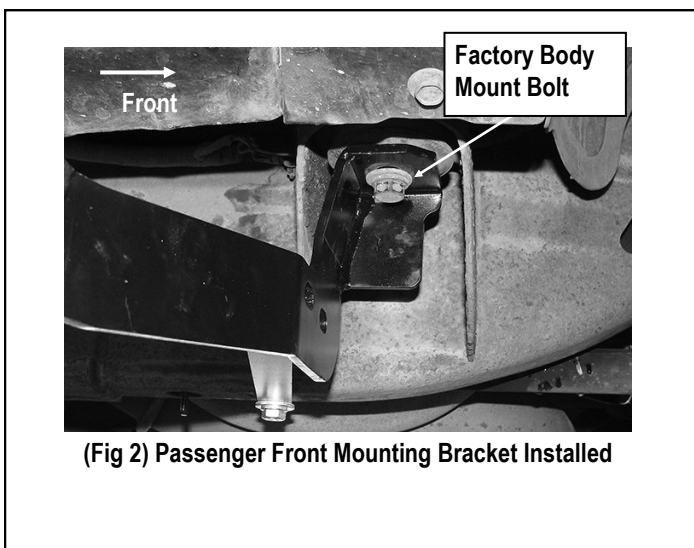

(Fig 2) Passenger Front Mounting Bracket Installed

STEP 3

Locate the two factory holes in the bottom of the frame towards the front of the vehicle, **(Fig 3)**. Insert (1) M10 Nut Plate into the oval hole and line up the threaded nut with the forward round hole, **(Fig 3)**. **NOTE: Nut Plate and Support Brackets are not required on 2011-Up 2500/3500 models.**

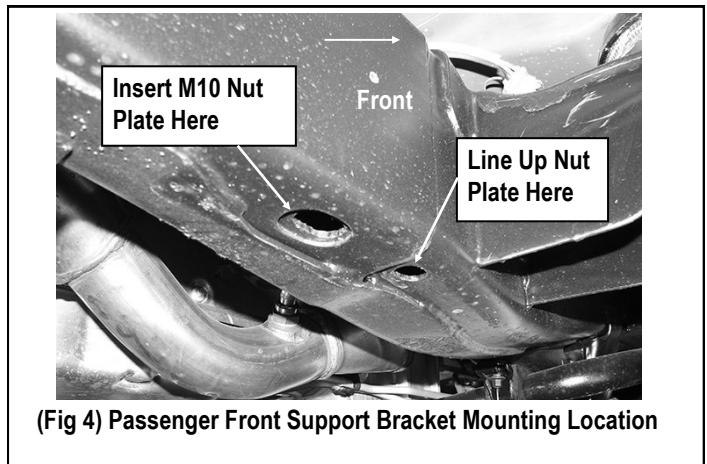

(Fig 4) Passenger Front Support Bracket Mounting Location

STEP 4

Attach the flat end of the Passenger Front Support Bracket to the M10 Nut Plate with (1) M10X1.5-30mm Hex Bolt, (1) M10 Flat Washer and (1) M10 Lock Washer, **(Fig 4 & 5)**. Do not tighten hardware at this time.

1500 Models:

Attach the bent end of the Support Bracket onto the Passenger Front Mounting Bracket with (1) M10X1.5-30mm Hex Bolt, (2) M10 Flat Washers, (1) M10 Lock Washer and (1) M10X1.5 Hex Nut, **(Fig 4)**. Do not tighten hardware at this time.

Up to 2010 2500/3500 Models:

Note that the Front Support Bracket will not reach up to the Mounting Bracket, **(Fig 5)**. Tighten the Support Bracket to the Nut Plate in the frame. Carefully push up on the Support Bracket until it reaches the inside hole in the Mounting Bracket. Bolt the Support Bracket to the hole in the Mounting Bracket with (1) M10X1.5-30mm Hex Bolt, (2) M10 Flat Washers, (1) M10 Lock

iBoard®

Washer and (1) M10X1.5 Hex Nut, (Fig 5). Do not tighten at this time.

Note: Support Bracket not required on 2011-Up 2500/3500 Models.

STEP 5

Move to the center body mount and remove the factory bolt. Select the Passenger Side Center Mounting Bracket . Repeat **Steps 1 - 2** to attach the Passenger Center Mounting Bracket . Next, select (1) Passenger Center Support Bracket . Slide one end of the Center Support Bracket between the factory body mount and the Center Mounting Bracket, (Fig 6 & 7). Attach the Support Bracket to the holes in the side of the body mount and the mounting bracket with (2) M10X1.5-30mm Hex Bolts, (2) M10 Large Flat Washers, (2) M10 Flat Washers, (2) M10 Lock Washers and (2) M10X1.5 Hex Nuts. Do not tighten at this time. **IMPORTANT: Center Support Brackets are not required on 2011—Up 2500/3500 Models.**

- (1) M10X1.5-30mm Hex Bolt
- (1) M10 Lock Washer
- (1) M10 Flat Washer

- (1) M10X1.5-30mm Hex Bolt
- (2) M10 Flat Washers
- (1) M10 Lock Washer
- (1) M10X1.5 Hex Nut

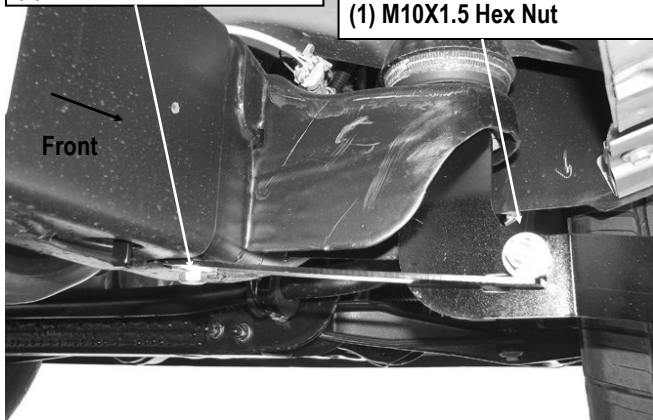

(Fig 4) Passenger Side Front Support Bracket Installed (1500 Models)

- (1) M10X1.5-30mm Hex Bolt
- (1) M10 Lock Washer
- (1) M10 Flat Washer

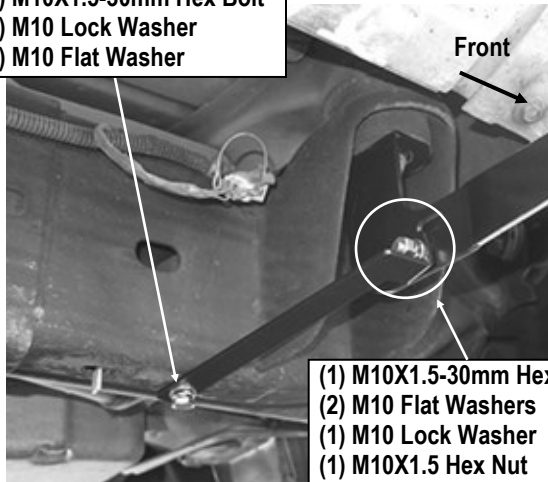

(Fig 5) Passenger Front Support Bracket Installed (Up to 2011 2500/3500 Models)

- (1) M10X1.5-30mm Hex Bolt
- (2) M10 Flat Washers
- (1) M10 Lock Washer
- (1) M10X1.5 Hex Nut

- (1) M10X1.5-30mm Hex Bolt
- (2) M10 Large Flat Washers
- (1) M10 Lock Washer
- (1) M10X1.5 Hex Nut



(Fig 6) Passenger Center Bracket Installed (1500 Models)

- (1) M10X1.5-30mm Hex Bolt
- (2) M10 Flat Washers
- (1) M10 Lock Washer
- (1) M10X1.5 Hex Nut

- (1) M10X1.5-30mm Hex Bolt
- (2) M10 Large Flat Washers
- (1) M10 Lock Washer
- (1) M10X1.5 Hex Nut



(Fig 7) Passenger Center Bracket Installed (Up to 2011 2500/3500 Models)

iBoard®

STEP 6

Assemble (1) Passenger Rear Bar Bracket and (1) Passenger Rear Mounting Bracket with (1) M10X1.5-30mm Hex Bolt, (2) M10 Flat Washers, (1) M10 Lock Washer and (1) M10X1.5 Hex Nut, (Fig 8). Leave hardware loose at this time

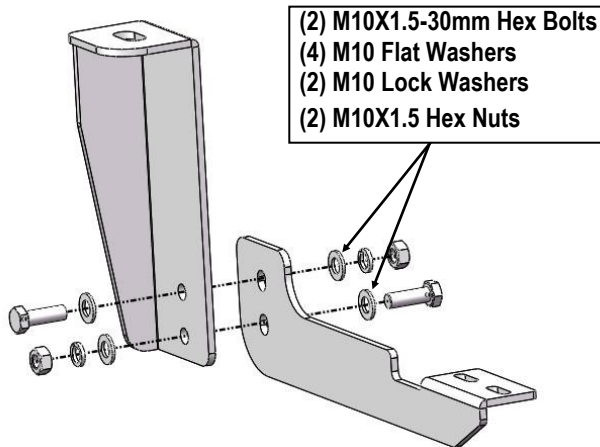

(Fig 8) Passenger Rear Mounting Bracket Assembly

STEP 7

Move to the rear body mount. Repeat **Steps 1 & 2** to attach the Assembled Passenger Rear Mounting Bracket (**PRM**) to the body mount, (Fig 9). Leave hardware loose at this time.

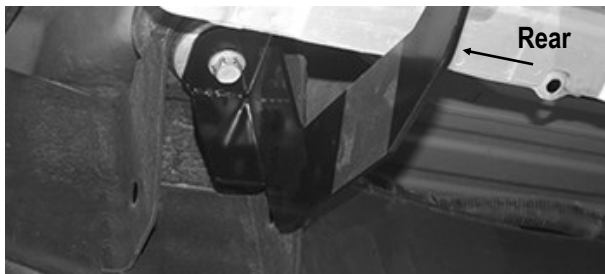

(Fig 9) Passenger Rear Mounting Bracket Installed

STEP 8

Once all (3) mounting brackets are installed, then proceed to the Step Bar installation. According to the style of Step Bar proceed to the correct installation STEPS.

Note: Aluminum Step Bar refer to STEP 9; Stainless Steel Step Bar skip to STEP 10.

STEP 9

Aluminum Step Bar Installation:

Select a **Aluminum Step Bar**. Slip (3) M6x1-20mm Square Head Bolts into each bottom channel (Fig 10). Carefully position the Step Bar onto the (3) Mounting Brackets.

IMPORTANT: Do not slide the Step Bar on the Brackets or the bottom surface of the board will be damaged. Attach the Step Bar to each Mounting Brackets with (2) M6x1-20mm Square Head Bolts, (2) M6 Large Flat Washers and (2) M6 Nylon Lock Nuts, (Fig 11). Do not fully tighten at this time.

Level and adjust the Step Bar and fully tighten all hardware. Repeat **Steps 1-9** for the other side Step Bar installation. **The installation is completed!!!**



(Fig 10) Slip M6X1-20mm Square Head Bolts Into The Bottom Channels

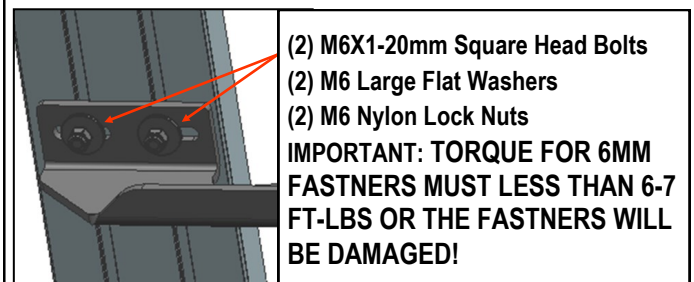

(Fig 11) Step Bar Installed Onto Mounting Bracket

iBoard®

STEP 10

Stainless Steel Step Bar Installation:

Select a **Stainless Steel Step Bar** (with the U-Sliders installed on the Bar). Loosen the U-Sliders, reposition the U-Sliders onto the board according to the (3) Installed Mounting Brackets location, (**Fig 12**). Re-secure the U-Sliders on the Step Bar. Attach the Step Bar to the installed Mounting Brackets with (6) M6X1-20mm Hex Bolts, (6) M6 Large Flat Washers & (6) M6 Lock Washers, (**Fig 13**). Do not fully tighten hardware at this time.

Level and adjust the Step Bar and fully tighten all hardware. Repeat **Steps 1-8 and 10** for the other side Step Bar installation.

The installation is completed!!!



(Fig 12) Slide & line up the U-Slider with the installed mounting brackets along bottom channel

(2) M6X1-20mm Hex Bolts
(2) M6 Large Flat Washers
(2) M6 Lock Washers
IMPORTANT: TORQUE FOR 6MM FASTNERS MUST LESS THAN 6-7 FT-LBS OR THE FASTNERS WILL BE DAMAGED!

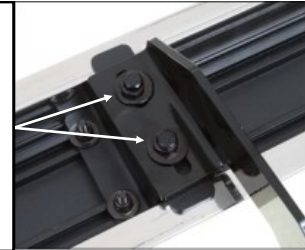

(Fig 13) Step Bar Installed on Bracket Installed (Example)

Attention

Do periodic inspections to the installation to make sure that all hardware is secure and tight.
In order to protect your bars/boards, please use only mild soap/non-abrasive products for cleaning.