

# iBoard®

## iBoard® by APS

PART#: IB-021

READ INSTRUCTIONS CAREFULLY BEFORE STARTING INSTALLATION. REMOVE CONTENTS FROM BOX AND VERIFY ALL PARTS ARE PRESENT. ASSISTANCE IS RECOMMENDED.

\*ROCKER PANEL MOUNT  
\*NO DRILLING REQUIRED

Fastener Size	Tightening Torque (ft-lbs)	Required
6mm	6-7	√
8mm	16-18	√
10mm	31-32	X
12mm	56-58	X
14mm	92-94	X

### PART LIST

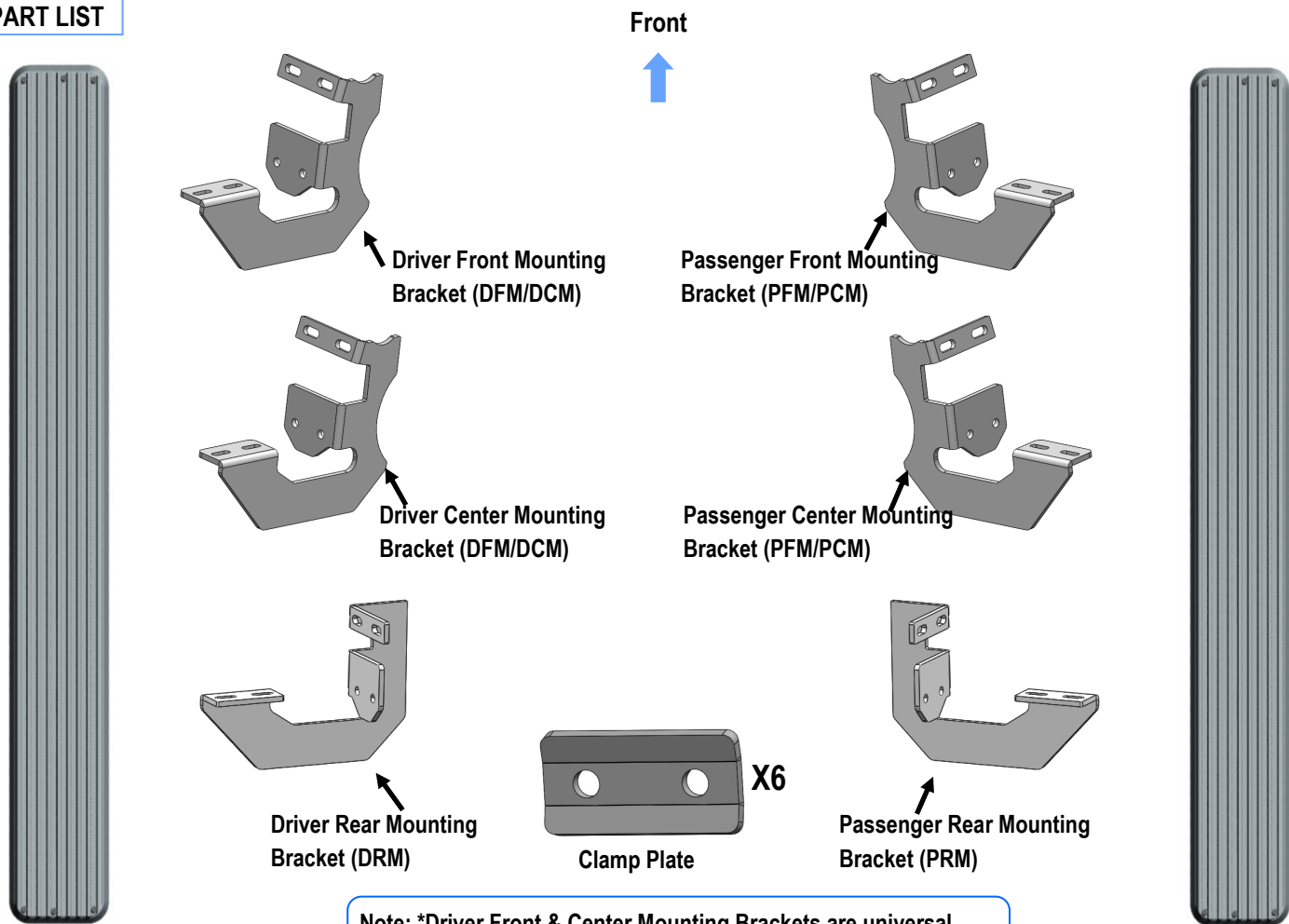

**Note:** \*Driver Front & Center Mounting Brackets are universal  
\*Passenger Front & Center Mounting Brackets are universal

Customer Support: [info@iboardauto.com](mailto:info@iboardauto.com)

# iBoard®

## Hardware Package A (For Bracket Installation)

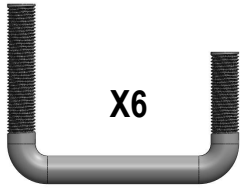

X6

M8 U-Bolt

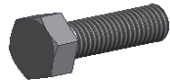

X12

M8X1.25-40mm Hex Bolt



X36

M8 Large Flat Washer



X24

M8 Lock Washer



X24

M8 Hex Nut

## Hardware Package B (For Aluminum Step Bar Installation Only, Not Supply to Stainless Steel Step Bar)

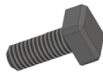

X12

M6X1-20mm Square Head Bolt



X12

M6 Large Flat Washer



X12

M6 Nylon Lock Nut

## Hardware Package C (For Stainless Steel Step Bar Installation Only, Not Supply to Aluminum Step Bar)

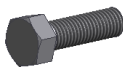

X12

M6X1-20mm Hex Bolt



X12

M6 Lock Washer



X12

M6 Flat Washer

## STEP 1

On the driver side of the vehicle, locate the (2) factory holes above rubber grommets on the side panel on the front, center and rear mounting locations, (Fig 1).

## STEP 2

Start the installation from the driver side front. Select (1) M8 U-Bolt. Insert the short end of the M8 U-Bolt into one of the factory holes and out from the opposite hole (Fig 2).

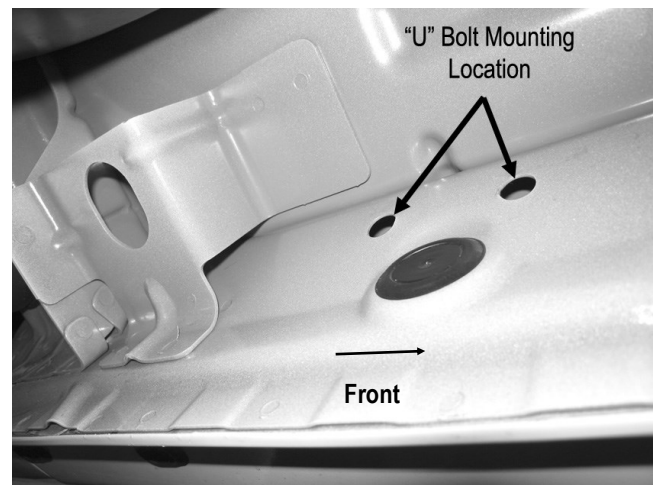

(Fig 1) Driver Side Front Mounting Bracket Location

# iBoard®

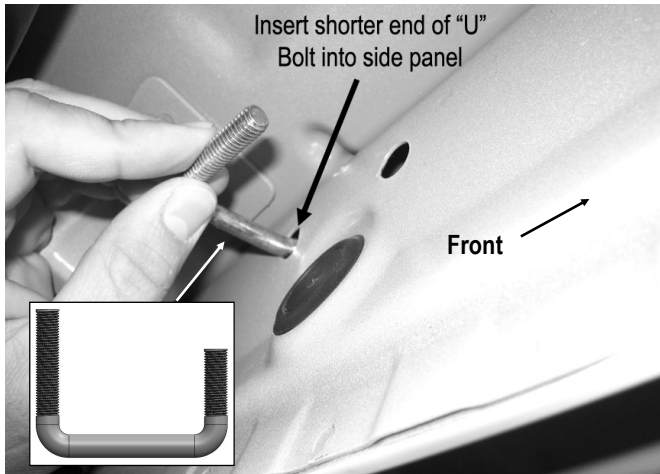

(Fig 2) Insert the M8 U-Bolt  
(Driver Side Front Mounting Location)

## STEP 3

Attach the Driver Front Mounting Bracket (DFM/DCM) to the installed M8 U-Bolt with (2) M8 Lock Washer, (2) M8 Large Flat Washers and (2) M8 Hex Nuts, (Fig 3). Do not fully tighten hardware at this time.

**NOTE:** Hold the U-Bolt in place and line up the threaded ends with the slots in the Mounting Bracket carefully. Do not let the U-Bolt fall into the body panel within installing.

(2) M8 Large Flat Washers  
(2) M8 Lock Washers  
(2) M8 Hex Nuts

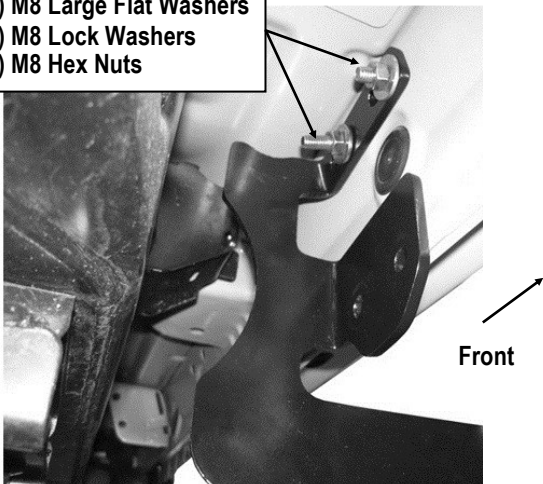

(Fig 3) Driver Side Front Mounting Bracket Installation

## STEP 4

Position (1) Clamp Plate on the pinch weld and line up with the Driver Front Mounting Bracket, (Fig 4). Attach the Clamp Plate to the Mounting Bracket with (2) M8X1.25-40mm Hex Bolts, (4) M8 Large Flat Washers, (2) M8 Lock Washers, and (2) M8 Hex Nuts, (Fig 5-7). Do not fully tighten hardware at this time.

**NOTE:** Mount the Clamp Plate with the concave facing the inside of the vehicle, (Fig 4).

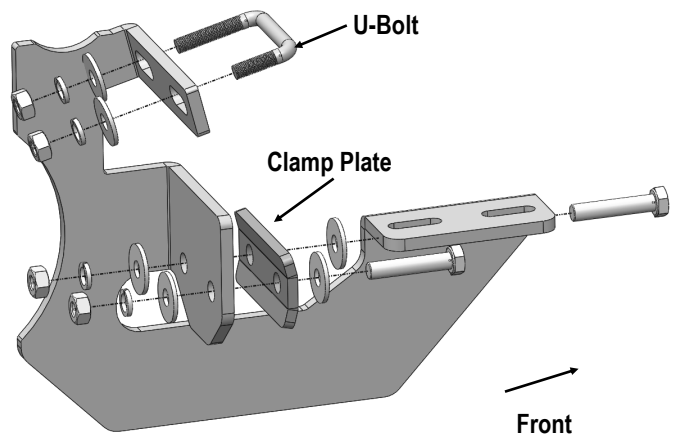

(Fig 4) Clamp Plate Installation  
(On Driver Side Front Mounting Location)

(2) M8X1.25-40mm Hex Bolts  
(4) M8 Large Flat Washers  
(2) M8 Lock Washers  
(2) M8 Hex Nuts

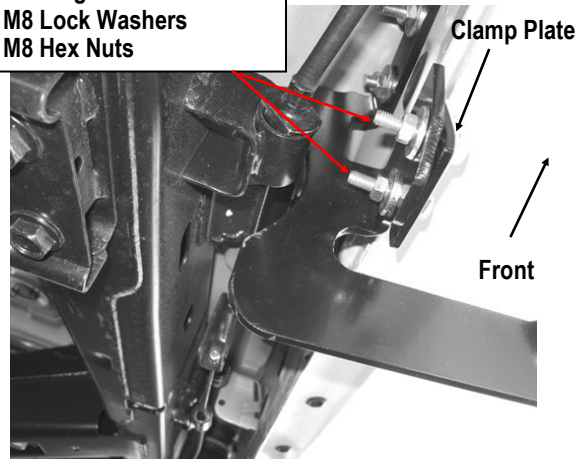

(Fig 5) Driver Side Front Mounting Bracket Installation

# iBoard®

## STEP 5

Move to the driver side center & rear mounting locations of the vehicle. Repeat **Steps 1-4** for Driver Center Mounting Bracket (**DFM/DCM**) & Driver Rear Mounting Bracket (**DRM**) installation, (**Fig 6 & 7**). Do not fully tighten hardware at this time.

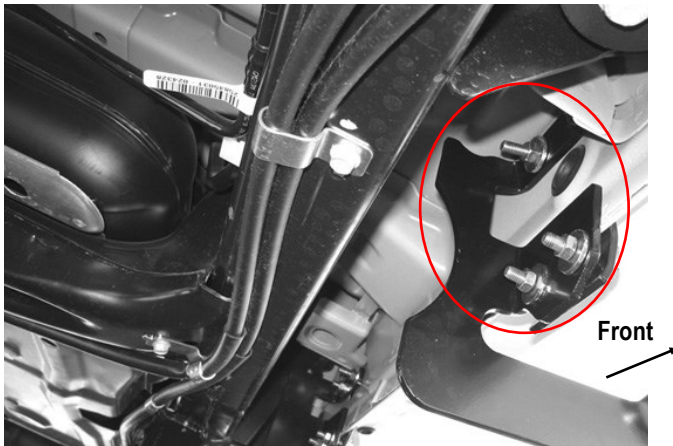

(Fig 6) Driver Side Center Mounting Bracket Installation

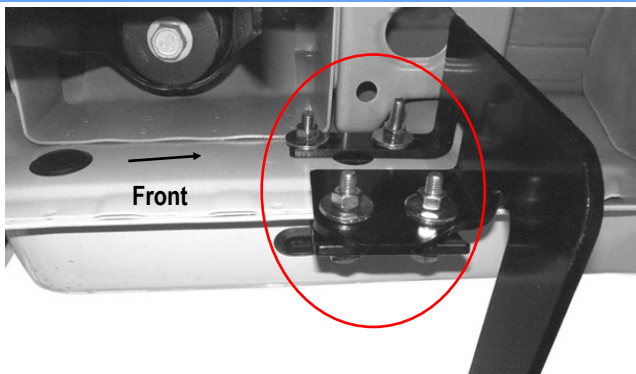

(Fig 7) Driver Side Rear Mounting Bracket Installation

## STEP 6

Once all (3) mounting brackets are installed, then proceed to the Step Bar installation. According to the style of Step Bar proceed to the correct installation STEPS.

**Note:** Aluminum Step Bar refer to **STEP 7**; Stainless Steel Step Bar skip to **STEP 8**.

## STEP 7

### **Aluminum Step Bar Installation:**

Select a **Aluminum Step Bar**. Slip (3) M6x1-20mm Square Head Bolts into each bottom channel (**Fig 8**). Carefully position the Step Bar onto the (3) Mounting Brackets.

**IMPORTANT:** Do not slide the Step Bar on the Brackets or the bottom surface of the board will be damaged. Attach the Step Bar to each Mounting Brackets with (2) M6x1-20mm Square Head Bolts, (2) M6 Large Flat Washers and (2) M6 Nylon Lock Nuts, (**Fig 9**). Do not fully tighten at this time.

Level and adjust the Step Bar and fully tighten all hardware. Repeat **Steps 1-7** for the other side Step Bar installation. **The installation is completed!!!**



(Fig 8) Slip M6X1-20mm Square Head Bolts Into The Bottom Channels

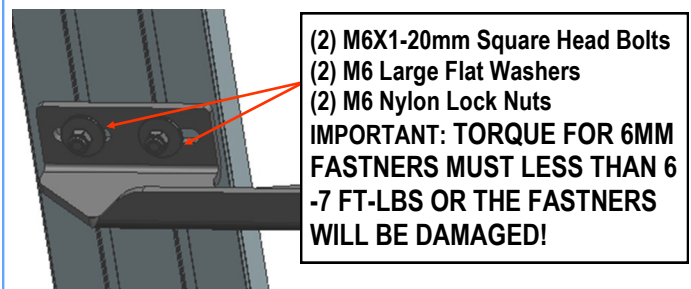

(Fig 9) Running Board Installed Onto Mounting Bracket

# iBoard®

## STEP 8

### **Stainless Steel Step Bar Installation:**

Select a **Stainless Steel Step Bar** (with the U-Sliders installed on the Bar). Loosen the U-Sliders, reposition the U-Sliders onto the board according to the (3) Installed Mounting Brackets location, **(Fig 10)**. Re-secure the U-Sliders on the Step Bar. Attach the Step Bar to the installed Mounting Brackets with (6) M6X1-20mm Hex Bolts, (6) M6 Large Flat Washers & (6) M6 Lock Washers, **(Fig 11)**. Do not fully tighten hardware at this time. Level and adjust the Step Bar and fully tighten all hardware. Repeat **Steps 1-6 and 8** for the other side Step Bar installation. **The installation is completed!!!**



**(Fig 10) Slide & line up the U-Slider with the installed mounting brackets along bottom channel**

- (2) M6X1-20mm Hex Bolts
- (2) M6 Large Flat Washers
- (2) M6 Lock Washers

**IMPORTANT: TORQUE FOR 6MM FASTNERS MUST LESS THAN 6-7 FT-LBS OR THE FASTNERS WILL BE DAMAGED!**

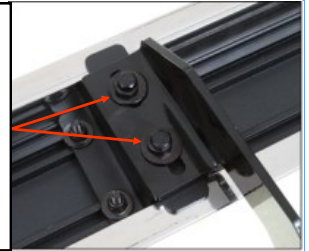

**(Fig 11) Step Bar Installed On Bracket Installed**

### **Attention**

**Do periodic inspections to the installation to make sure that all hardware is secure and tight.**

**In order to protect your bars/boards, please use mild soap/non-abrasive products for cleaning only.**