



iBoard® by APS

PART#: IB-131C&H

READ INSTRUCTIONS CAREFULLY BEFORE STARTING INSTALLATION. REMOVE CONTENTS FROM BOX AND VERIFY ALL PARTS ARE PRESENT. ASSISTANCE IS RECOMMENDED.

*BODY FRAME MOUNT
*NO DRILLING REQUIRED

Fastener Size	Tightening Torque (ft-lbs)	Required
6mm	6-7	X
8mm	16-18	√
10mm	31-32	X
12mm	56-58	√
14mm	92-94	X

PART LIST

Driver Side Step Bar

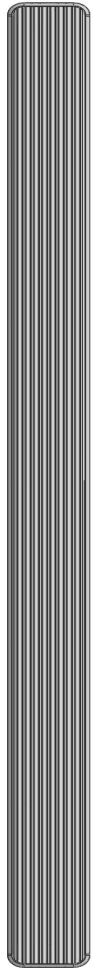

Driver Front Mounting Bracket (DFM)

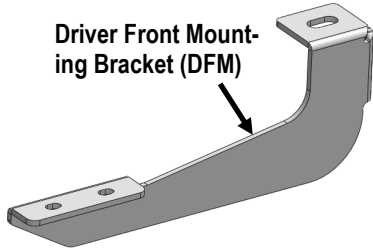

Driver/Passenger Center Mounting Bracket (DCM/PCM)

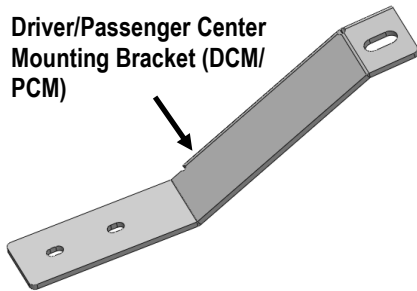

Driver Rear Mounting Bracket (DRM)

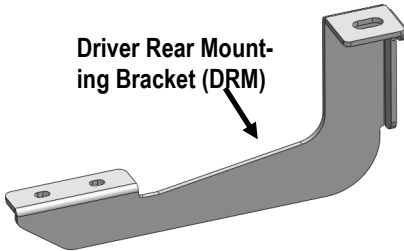

Front



Passenger Side Step Bar

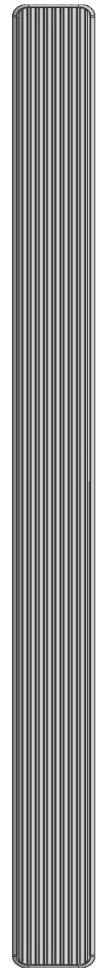

Passenger Front Mounting Bracket (PFM)

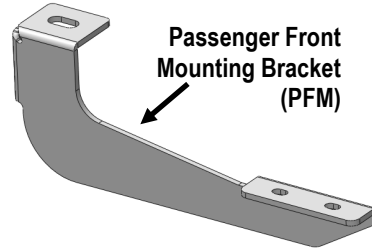

(DCM/PCM)

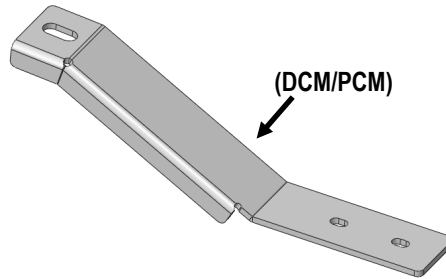

Passenger Rear Mounting Bracket (PRM)

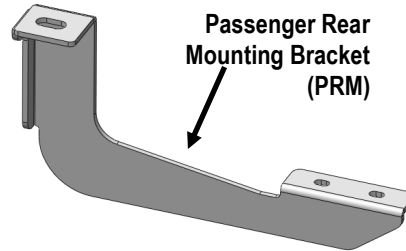

Note: Driver Center Mounting Bracket & Passenger Center Mounting Bracket Are Universal



Hardware Package A (For Bracket Installation)

Item	QTY	Description	Item	QTY	Description
1#	6	M12X1.75-120mm Hex Bolts	3#	6	M12 Lock Washer
2#	6	M12 Large Flat Washers	5#		



1#



2#



3#

Hardware Package B (For Stainless Steel Step Bar Installation)

Item	QTY	Description	Item	QTY	Description
1#	12	M8X1.25-35mm Carriage Bolts	3#	12	M8 Nylon Lock Nuts
2#	12	M8 Large Flat Washers	4#	6	Sliders (Packed with Step Bars)

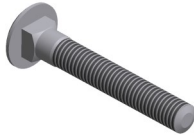

1#



2#



3#

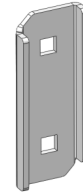

4#



STEP 1

Start the installation under the Driver side of the vehicle. Remove the front and rear body mount hex bolts. Do not remove the rubber bushings, (Fig 1).

STEP 2

Hang the driver side front / center and rear Mounting Brackets to the body mounts using the factory hex bolts.

NOTE: On some model years, the factory bolt and flat washer can not be reinstalled due to Bracket interference. Replace the factory hex bolts and washers with the included M12X1.75-120mm Hex Bolts, M12 Lock Washers and M12 Large Flat Washers, (Fig 2). Do not tighten hardware at this time.

Factory Body
Mount Bolt

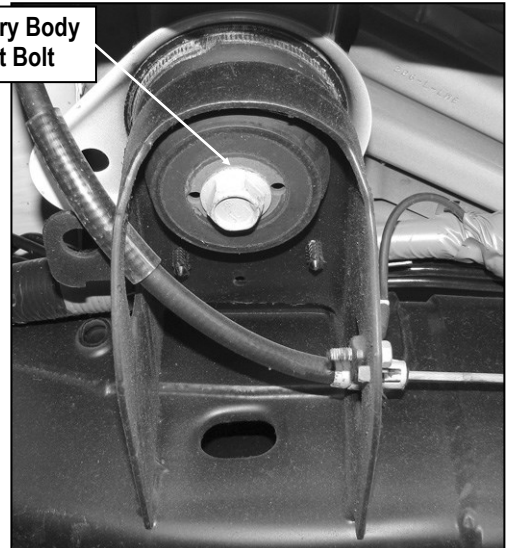

(Fig 1) Driver Side Front Mounting Location

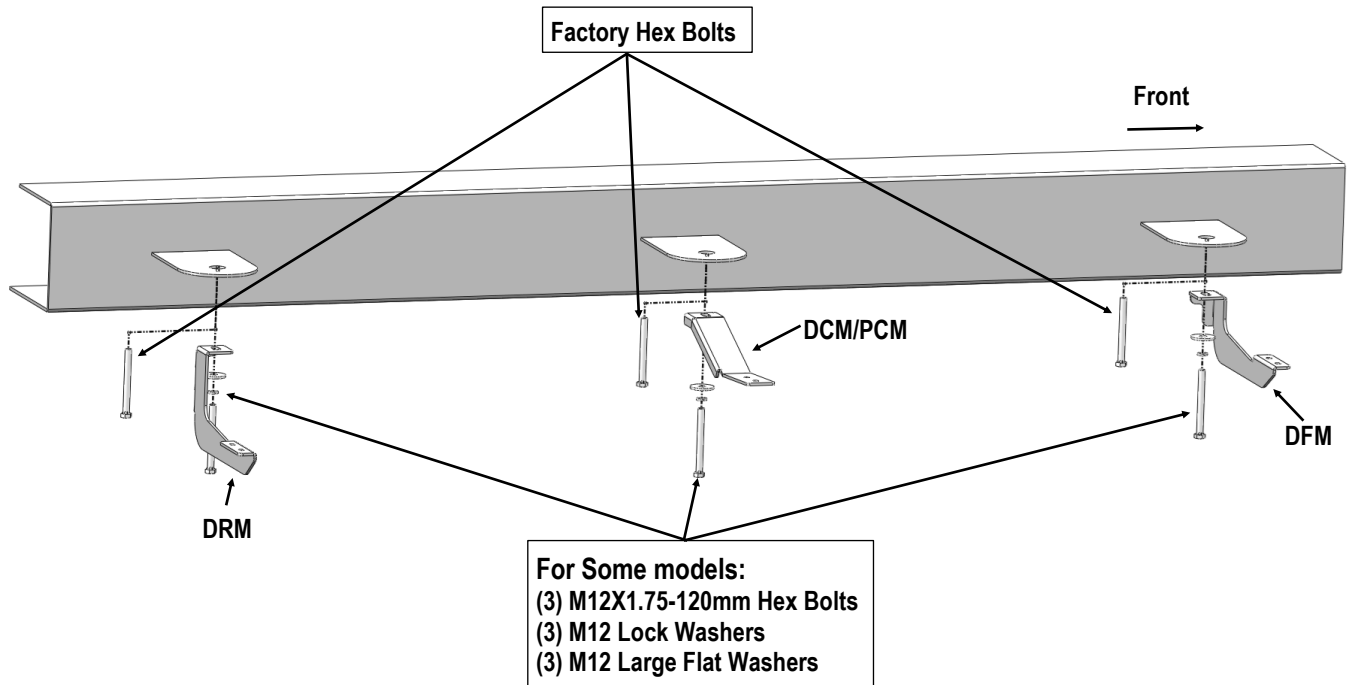

(Fig 2) Driver Side Mounting Brackets Installation



STEP 3

Once all (3) Driver side mounting brackets are installed, then proceed to the Step Bar installation. (Figs 3 & 4)

- (1) Select (1) Slider and (2) M8X1.25-35mm Carriage Bolts;
- (2) Install (2) M8X1.25-35mm Carriage Bolts in (1) Slider.
- (3) Slide the Slider (with carriage bolts) to the **Step Bar**.
- (4) Repeat to install the other (2) sliders to the step bar.
- (5) Attach the Step Bar (with the Sliders) onto the installed mounting brackets. Position the Sliders to the installed brackets. Secure the Step Bar to the installed Brackets by using (6) M8 Large Flat Washers and (6) M8 Nylon Lock Nuts and (3) Sliders, (Fig 4). Do not fully tighten hardware at this time.

Note: The Sliders are packed with the Step Bars.

Level and adjust the Step Bar and fully tighten all hardware.

Repeat **Steps 1-3** for the other side Step Bar installation. **The installation is completed!!!**

Attention

Do periodic inspections to the installation to make sure that all hardware is secure and tight.

In order to protect your bars/boards, please use mild soap/non-abrasive products for cleaning only.

