

# iBoard®

## iBoard® by APS

PART#: IB-296

READ INSTRUCTIONS CAREFULLY BEFORE STARTING INSTALLATION. REMOVE CONTENTS FROM BOX AND VERIFY ALL PARTS ARE PRESENT. ASSISTANCE IS RECOMMENDED.

\*ROCKER PANEL MOUNT  
\*NO DRILLING REQUIRED

Fastener Size	Tightening Torque (ft-lbs)	Required
6mm	6-7	√
8mm	16-18	√
10mm	31-32	X
12mm	56-58	X
14mm	92-94	X

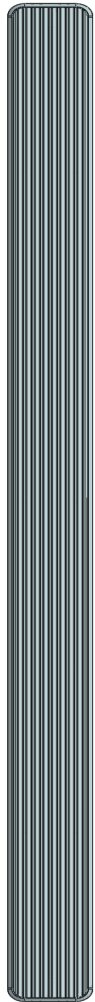

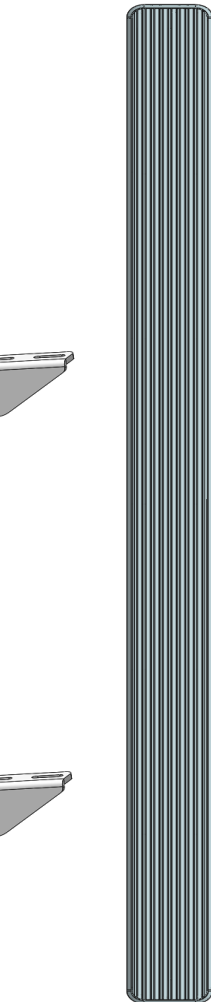
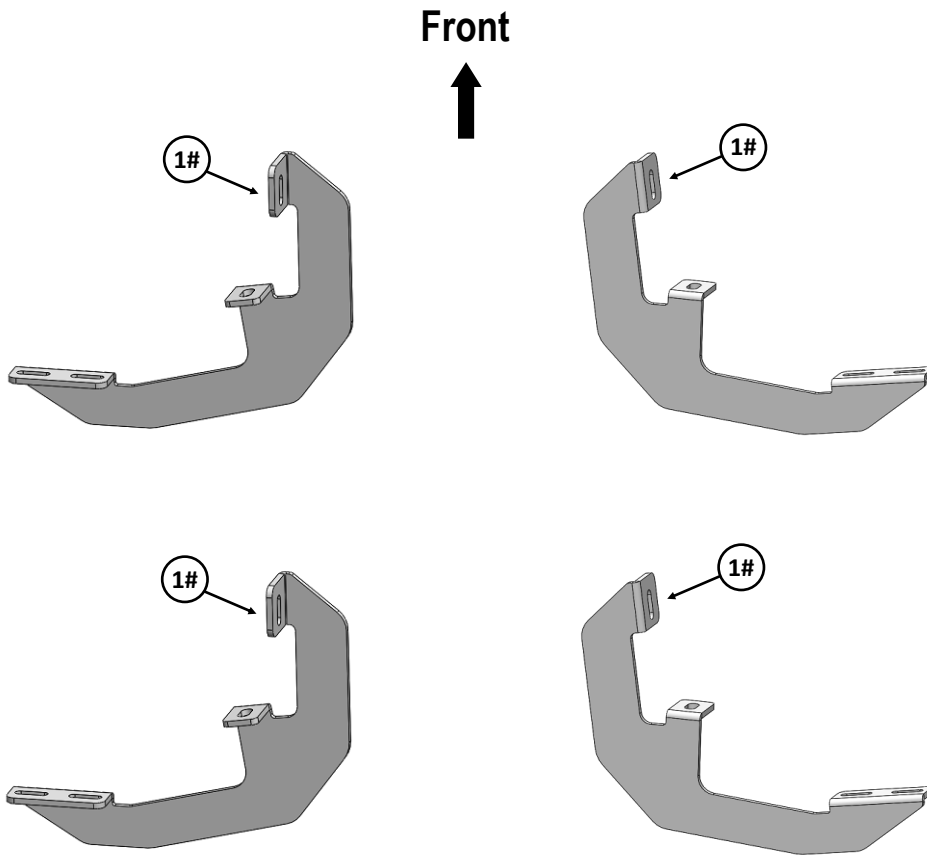

Driver Side Step Bar







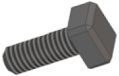

Passenger Side Step Bar

# iBoard®

Mounting Bracket List					
Item	QTY	Description	Item	QTY	Description
1#	4	Mounting Brackets			

Hardware Package A (For Bracket Installation)					
Item	QTY	Description	Item	QTY	Description
1#	8	M8X1.25-30mm Hex Bolts	3#	8	M8 Lock Washers
2#	8	M8 Flat Washers			
 1#  2#  3#					

Hardware Package B (For Aluminum Step Bar Installation Only, Not Supply to SS. Step Bar)					
Item	QTY	Description	Item	QTY	Description
1#	8	M6X1-20mm Square Head Bolts	3#	8	M6X1 Nylon Lock Nuts
2#	8	M6 Large Flat Washers			
 1#  2#  3#					

Hardware Package C (For Stainless Steel Step Bar Installation Only, Not Supply to Aluminum Step Bar)					
Item	QTY	Description	Item	QTY	Description
1#	8	M6X1-20mm Hex Bolts	3#	8	M6 Flat Washers
2#	8	M6 Lock Washers			
 1#  2#  3#					

# iBoard®

## STEP 1

Starting on the driver side of the vehicle. Locate the (4) plugs along the bottom edge of the body. Remove the plastic plugs from each mounting location, (Fig 1).

**NOTE:** Thread a M8 Hex Bolt into the threaded inserts to clear paint as required.

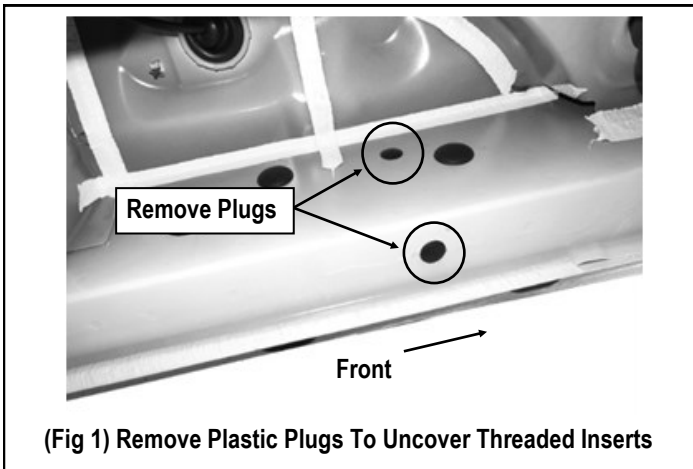

(Fig 1) Remove Plastic Plugs To Uncover Threaded Inserts

## STEP 2

Start from the driver front mounting location, (Fig 2). Bolt the Driver Front Mounting Bracket to the factory threaded holes with (2) M8X1.25-30mm Hex Bolts, (2) M8 Flat Washers and (2) M8 Lock Washers, (Fig 3). Do not fully tighten hardware at this time.

## STEP 3

Move to driver side rear mounting location, (Fig 4). Repeat **Step 2** to bolt the Driver Rear Mounting Bracket to the factory threaded holes. Do not fully tighten hardware at this time.

## STEP 4

Once all (2) mounting brackets are installed, then proceed to the Step Bar installation. According to the style of Step Bar proceed to the correct installation STEPS.

**Note:** Aluminum Step Bar refer to **STEP 5**; Stainless Steel Step Bar skip to **STEP 6**.

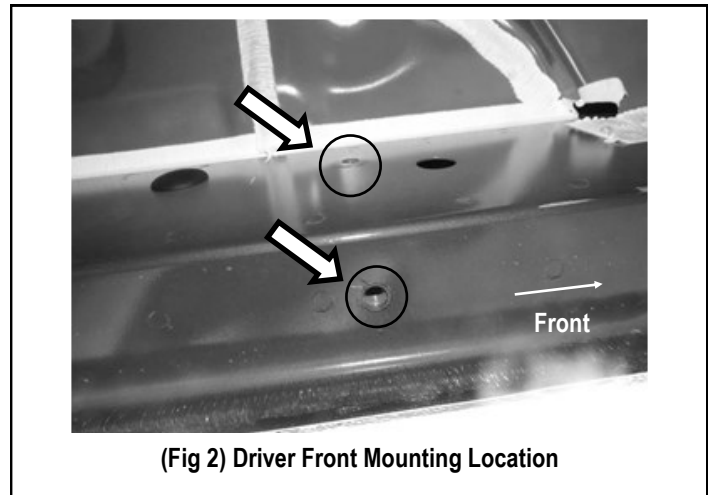

(Fig 2) Driver Front Mounting Location

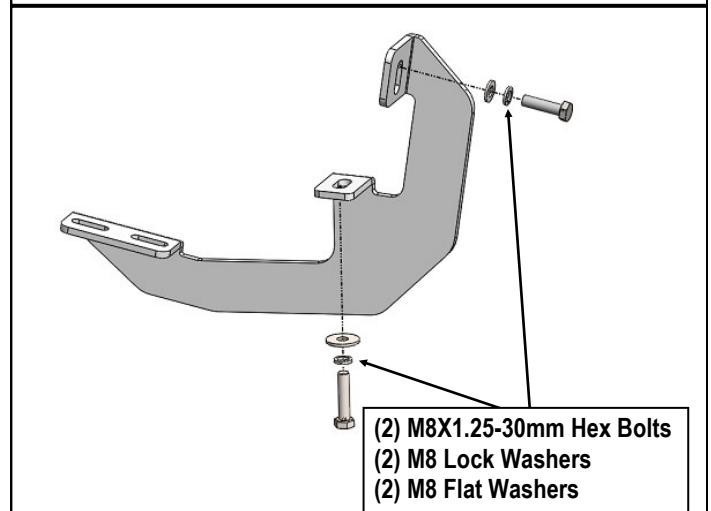

(Fig 3) Driver Front Mounting Bracket Installation

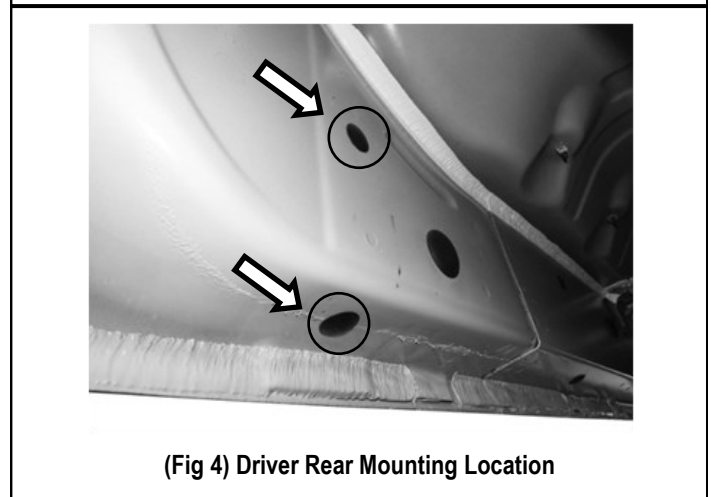

(Fig 4) Driver Rear Mounting Location

# iBoard®

## STEP 5

### Aluminum Step Bar Installation:

Select a **Aluminum Step Bar**. Slip (2) M6x1-20mm Square Head Bolts into each bottom channel (**Fig 5**). Carefully position the Step Bar onto the (2) Mounting Brackets.

**IMPORTANT:** Do not slide the Step Bar on the Brackets or the bottom surface of the board will be damaged. Attach the Step Bar to each Mounting Brackets with (2) M6x1-20mm Square Head Bolts, (2) M6 Large Flat Washers and (2) M6X1 Nylon Lock Nuts, (**Fig 6**). Do not fully tighten at this time. Level and adjust the Step Bar and fully tighten all hardware. Repeat **Steps 1-5** for the other side Step Bar installation. **The installation is completed!!!**



(Fig 5) Slip M6X1-20mm Square Head Bolts Into The Bottom Channels

## STEP 6

### Stainless Steel Step Bar Installation:

Select a **Stainless Steel Step Bar** (with the U-Sliders installed on the Bar). Loose the U-Sliders, reposition the U-Sliders onto the board according to the (2) Installed Mounting Brackets location, (**Fig 7**). Re-secure the U-Sliders on the Step Bar. Attach the Step Bar to the installed Mounting Brackets with (4) M6X1-20mm Hex Bolts, (4) M6 Large Flat Washers & (4) M6 Lock Washers, (**Fig 8**). Do not fully tighten hardware at this time. Level and adjust the Step Bar and fully tighten all hardware. Repeat **Steps 1-4 and 6** for the other side Step Bar installation. **The installation is completed!!!**

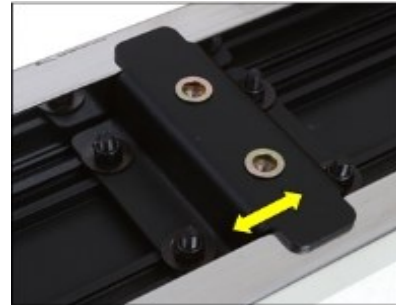

(Fig 7) Slide & line up the U-Slider with the installed mounting brackets along bottom channel

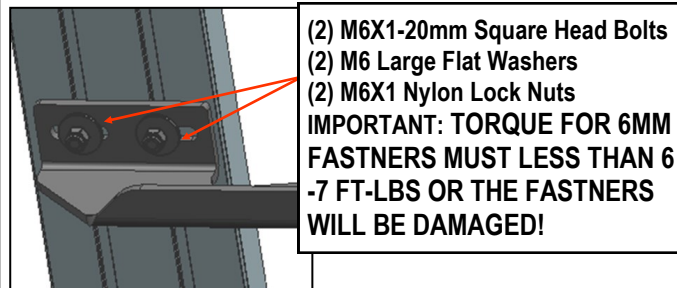

(Fig 6) Running Board Installed Onto Mounting Bracket

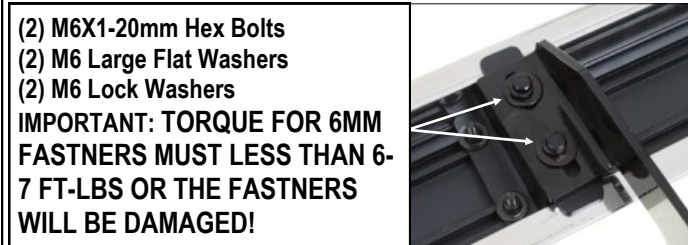

(Fig 8) Step Bar Installed on Bracket Installed (Example)

### Attention

Do periodic inspections to the installation to make sure that all hardware is secure and tight. In order to protect your bars/boards, please use only mild soap/non-abrasive products for cleaning.