

iBoard®

iBoard® by APS

PART#: IB-196

READ INSTRUCTIONS CAREFULLY BEFORE STARTING INSTALLATION. REMOVE CONTENTS FROM BOX AND VERIFY ALL PARTS ARE PRESENT. ASSISTANCE IS RECOMMENDED.

*ROCKER PANEL MOUNT
*NO DRILLING REQUIRED/ TRIMMING MAY BE REQUIRED

Fastener Size	Tightening Torque (ft-lbs)	Required
6mm	6-7	√
8mm	16-18	√
10mm	31-32	X
12mm	56-58	X
14mm	92-94	X

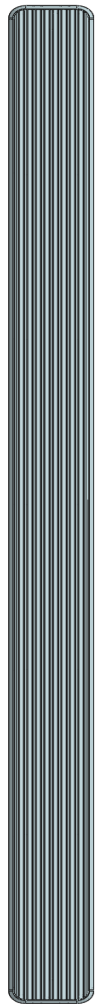

Driver Side Step Bar

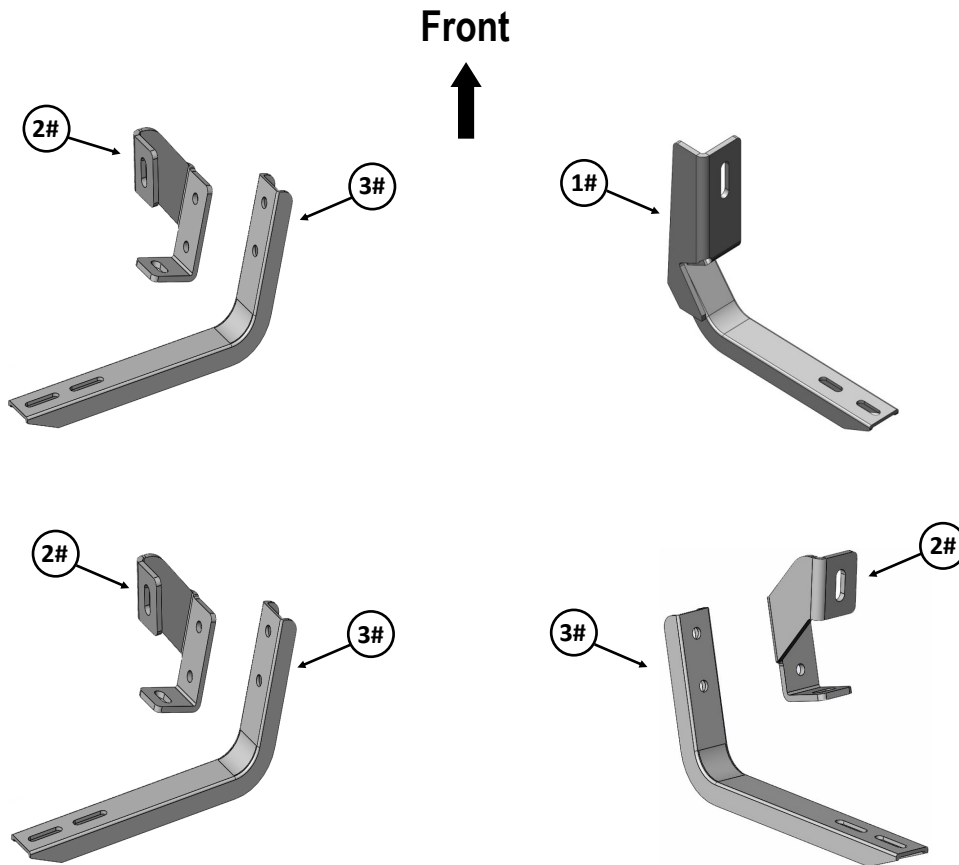



Passenger Side Step Bar

iBoard®

Mounting Bracket List					
Item	QTY	Description	Item	QTY	Description
1#	1	Passenger Front Mounting Bracket	3#	3	Bar Brackets
2#	3	Mounting Brackets			

Hardware Package A (For Bracket Installation)					
Item	QTY	Description	Item	QTY	Description
1#	1	SQ Spacer	6#	8	M8X1.25-25mm Hex Bolts
2#	6	M8X1.25-20mm Inner Hex Bolts	7#	9	M8 Flat Washers
3#	6	M8X1.25 Hex Flange Nuts	8#	9	M8 Lock Washers
4#	1	M8X1.25-35mm Hex Bolt	9#	7	M8 Clip Nuts
5#	1	M8X1.25 Nylon Lock Nut			

 1 #

 2 #

 3 #

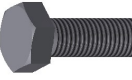
 4 #

 5 #

 6 #

 7 #

 8 #

 9 #

Hardware Package B (For Aluminum Step Bar Installation Only, Not Supply to SS. Step Bar)					
Item	QTY	Description	Item	QTY	Description
1#	8	M6X1-20mm Square Head Bolts	3#	8	M6X1 Nylon Lock Nuts
2#	8	M6 Large Flat Washers			

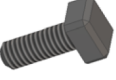
 1 #

 2 #

 3 #

Hardware Package C (For Stainless Steel Step Bar Installation Only, Not Supply to Aluminum Step Bar)					
Item	QTY	Description	Item	QTY	Description
1#	8	M6X1-20mm Hex Bolts	3#	8	M6 Flat Washers
2#	8	M6 Lock Washers			

 1 #

 2 #

 3 #

iBoard®

STEP 1

Start the installation from the driver side of the vehicle. Locate the mounting tabs along the bottom edge of the body, (pinch weld). Mounting brackets will bolt to the mounting tabs. Directly above each tab, there is another top mounting location on the inner side of the body panel. (Fig 1).

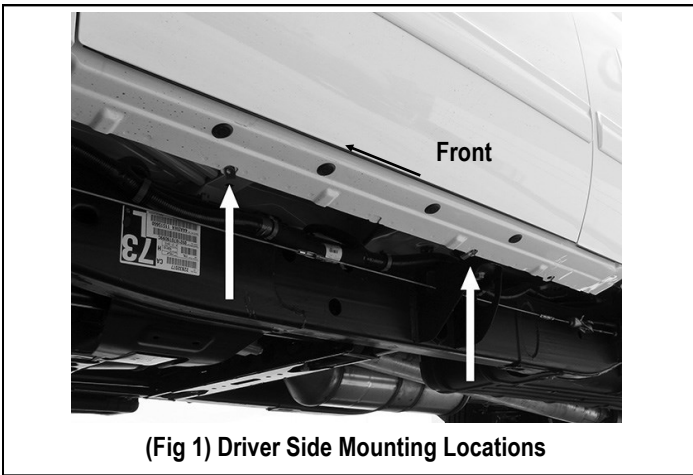

(Fig 1) Driver Side Mounting Locations

STEP 2

Determine the correct procedure for your model year and each Bracket location.

- A. Lower mounting location on the edge of the pinch weld**
- a) Flat tab on pinch weld with factory installed weld nut:** Thread the M8X1.25-25mm Hex Bolt into the welded nut to clear paint from threads as required, (Fig 2).
 - b) Flat tab on pinch weld with hole (Fig 3,4) :** Select (1) M8 Clip Nut. Slide the Clip Nut over the tab with the nut facing up behind the tab. Repeat this **Step** for Driver Rear mounting location.

B. Upper mounting location on the inner side of the body panel:

- a) Models with factory installed threaded insert in body panel:** Thread M8X1.25-25mm Hex Bolt into the threaded insert to clear paint as required, (Fig 2).
- b) Models with large and small holes on the body panel (Fig 3, 4):** Remove the rubber plug from the larger hole. Select (1) M8 Clip Nut. Insert the Clip Nut into the larger hole with the thread facing inner side.

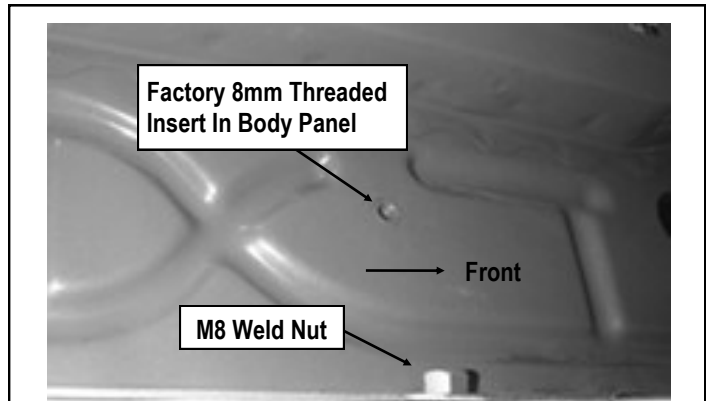

(Fig 2) Driver Front Mounting Bracket Location

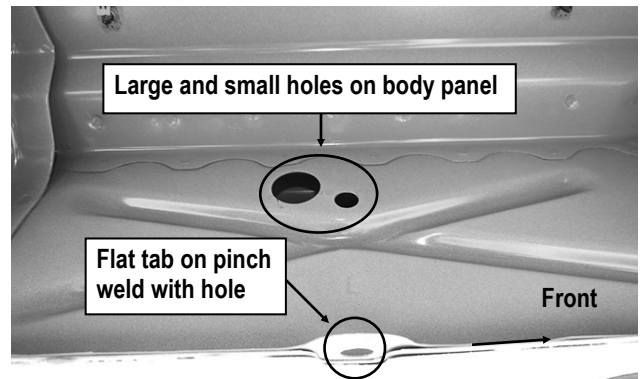

(Fig 3) Driver Side Front Mounting Location (Flat tab on Pinch Weld with hole)

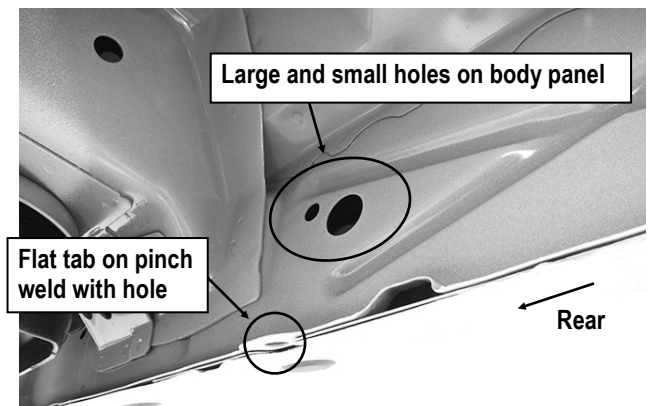

(Fig 4) Driver Side Rear Mounting Location (Flat tab on Pinch Weld with hole)

iBoard®

STEP 3

Assemble (1) Mounting Bracket and (1) Bar Bracket with (2) M8X1.25-20mm Inner Hex Bolts and (2) M8X1.25 Hex Flange Nuts, (Fig 5).

And then Bolt the Assembled Mounting Bracket to the to the driver side front mounting location with (2) M8 x1.25-25mm Hex Bolts, (2) M8 Lock Washers and (2) M8 Large Flat Washers, (Fig 6). Snug but do not fully tighten the hardware.

Mounting Bracket
(Universal)

Bar Bracket
(Universal)

(2) M8X1.25-20mm
Inner Hex Bolts
(2) M8X1.25 Hex
Flange Nuts

(Fig 5) Driver Front Mounting Bracket Assembled

M8 Clip Nut (For
Models with
hole on body
panel only)

M8 Clip Nut (For
Models with hole
on pinch weld only)

(2) M8 x 1.25-25mm Hex Bolts
(2) M8 Lock Washers
(2) M8 Flat Washers

(Fig 6) Assembled Driver Front Bracket Installed

STEP 4

Repeat **Steps 1—3** to install the driver side rear Brackets.

STEP 5

Once all (2) mounting brackets are installed, then proceed to the Step Bar installation. According to the style of Step Bar proceed to the correct installation STEPS.

Note: Aluminum Step Bar refer to **STEP 6**; Stainless Steel Step Bar skip to **STEP 7**.

STEP 6

Aluminum Step Bar Installation:

Select a **Aluminum Step Bar**. Slip (2) M6x1-20mm Square Head Bolts into each bottom channel (Fig 8). Carefully position the Step Bar onto the (2) Mounting Brackets.

IMPORTANT: Do not slide the Step Bar on the Brackets or the bottom surface of the board will be damaged. Attach the Step Bar to each Mounting Brackets with (2) M6x1-20mm Square Head Bolts, (2) M6 Large Flat Washers and (2) M6X1 Nylon Lock Nuts, (Fig 9). Do not fully tighten at this time.

Level and adjust the Step Bar and fully tighten all hardware. Repeat **Steps 1-6** for the other side Step Bar installation.



(Fig 7) Slip M6X1-20mm Square Head Bolts Into The Bottom Channels

iBoard®

(2) M6X1-20mm Square Head Bolts
(2) M6 Large Flat Washers
(2) M6X1 Nylon Lock Nuts
IMPORTANT: TORQUE FOR 6MM FASTNERS MUST LESS THAN 6-7 FT-LBS OR THE FASTNERS WILL BE DAMAGED!

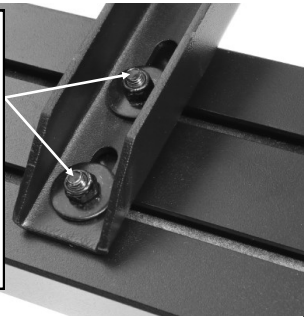

(Fig 8) Running Board Installed Onto Mounting Bracket

STEP 7

Stainless Steel Step Bar Installation:

Select a **Stainless Steel Step Bar** (with the U-Sliders installed on the Bar). Loosen the U-Sliders, reposition the U-Sliders onto the board according to the (2) Installed Mounting Brackets location, (Fig 9). Re-secure the U-Sliders on the Step Bar. Attach the Step Bar to the installed Mounting Brackets with (4) M6X1-20mm Hex Bolts, (4) M6 Large Flat Washers & (4) M6 Lock Washers, (Fig 10). Do not fully tighten hardware at this time. Level and adjust the Step Bar and fully tighten all hardware. Repeat **Steps 1-5 and 7** for the other side Step Bar installation.



(Fig 9) Slide & line up the U-Slider with the installed mounting brackets along bottom channel

(2) M6X1-20mm Hex Bolts
(2) M6 Large Flat Washers
(2) M6 Lock Washers
IMPORTANT: TORQUE FOR 6MM FASTNERS MUST LESS THAN 6-7 FT-LBS OR THE FASTNERS WILL BE DAMAGED!

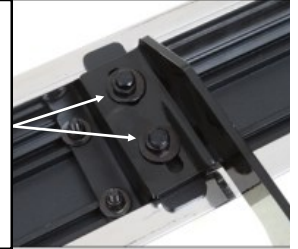

(Fig 10) Step Bar Installed on Bracket Installed (Example)

STEP 8

Move to the passenger side of the vehicle. On the passenger side, determine if the vehicle is equipped with a plastic diesel exhaust fluid (DEF) tank, (Fig 11 & 12).

Models without DEF tank, skip to Step 9.

Models with DEF tank, first determine correct procedure for your model year:

• **2007-2016 Models with DEF tank:**

The tank sits close to the side of the body. With specialized tools, the Passenger Front Mounting Bracket can be installed but room is limited. It may be easier to drop the tank down to access the inner side of the body panel to mount the bracket. Tank will not need to be removed, only dropped down for access to mounting location.

IMPORTANT: If tank is full, it will be very heavy, and assistance is highly recommended to avoid injury or damage to the vehicle or the tank. It is recommended that installation is performed when the DEF tank is low on fluid before dropping down the tank.

a. On models with plastic lower tray under the tank, remove the (3) hex bolts attaching the tray to the frame, (Fig 11), and remove the tray.

b. Release the tank filler hose. Release the plug for the sending unit on the top of the tank.

c. Support the tank with a floor jack. Place a smooth flat surface, (wooden block for example), between the floor jack and the tank to avoid damaging the plastic tank. Do not push up on the tank; only support the weight of the tank with the jack.

d. Remove the (2) bolts securing the tank straps to the vehicle, (Fig 12). Tilt the straps to release from the brackets. Slowly lower the tank until the top of the tank is almost visible. Use

iBoard®

blocks or stands to support the tank while installing the Passenger Front Mounting Bracket.

e. Proceed to **Step 9**

● **2017-on 2500/3500 models:**

Do not remove the tank. Remove the (4) hex bolts attaching the plastic cover to DEF tank, (Fig 13A) and remove the plastic cover only, (Fig 13B).

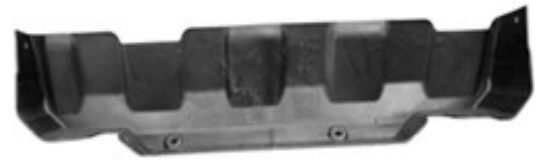

(Fig 13B) 17-on Passenger side DEF cover removed

STEP 9

Locate the first tab on the edge of the pinch weld, attach the Passenger Front Mounting Bracket to the pinch weld and top body panel (Fig 14 & 15):

- Models with flat tab and hole:** see Fig 14. Leave loose at this time.
- Models with weld-nut:** see Fig 15. Leave loose at this time.

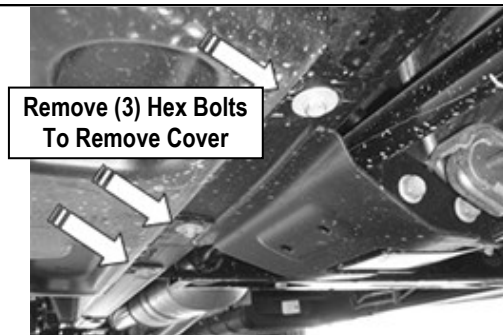

(Fig 11) 07-16 Passenger Side Front With DEF Tank Cover

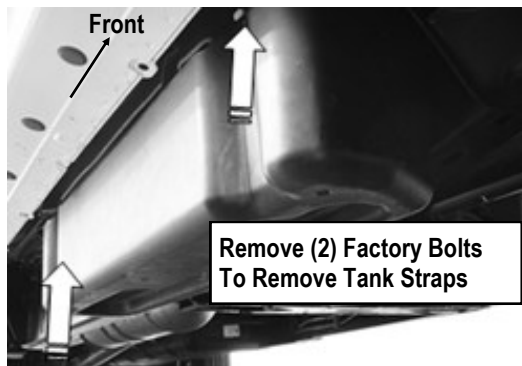

(Fig 12) Passenger side 07-16 DEF tank and cover

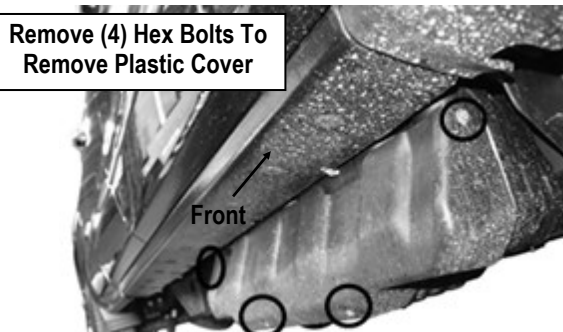

(Fig 13A) 2017-Up Passenger Side Pictured With DEF Plastic Tank Cover.

- (1) M8X1.25-25mm Hex Bolt
- (1) M8 Flat Washer
- (1) M8 Lock Washer
- (1) M8 Clip Nut

- (1) M8X1.25-35mm Hex Bolt
- (1) M8 Flat Washer
- (1) M8 Lock Washer
- (1) M8 Nylon Lock Nut
- (1) SQ Spacer

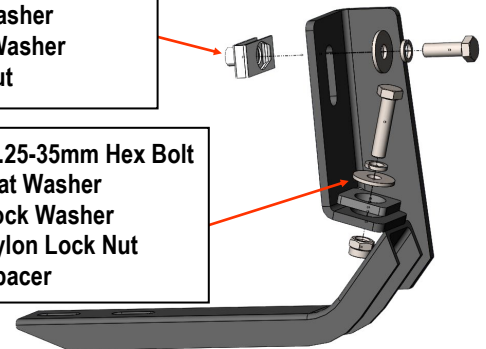

(Fig 14) Passenger Front Mounting Bracket Installed (Models with flat tab and hole)

iBoard®

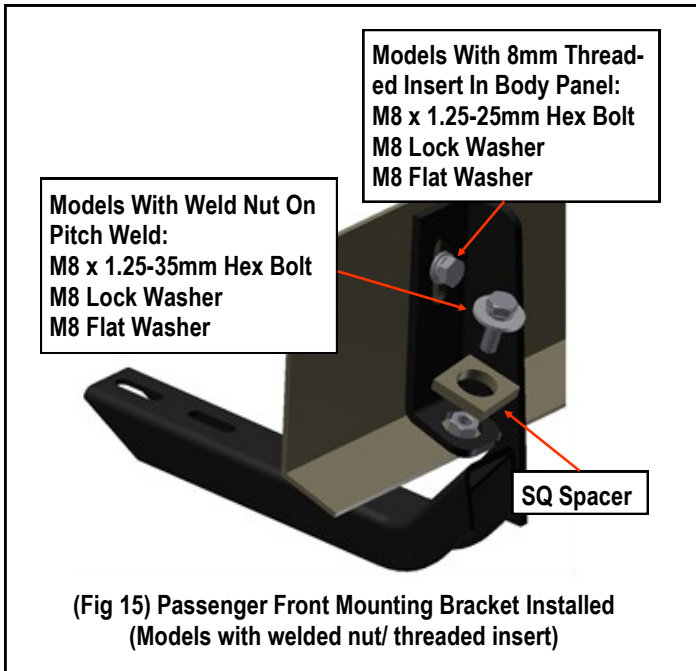

STEP 10

Repeat **Steps 1—5** for the passenger side rear mounting bracket installation.

2017-up 2500/3500 DEF tank models: Locate the rear tab bracket location along the bottom edge of the body, (pinch weld), (**Fig 16**). Hold the DEF cover in place and mark the Rear Bracket location onto the cover, (**Fig 17**). Use a sharp knife or hacksaw blade to carefully cut a slot in the plastic cover to clear the Rear Bracket, (**Fig 18**). Remove as little plastic as possible.

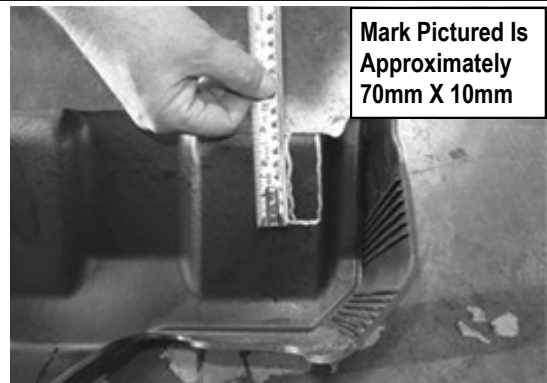
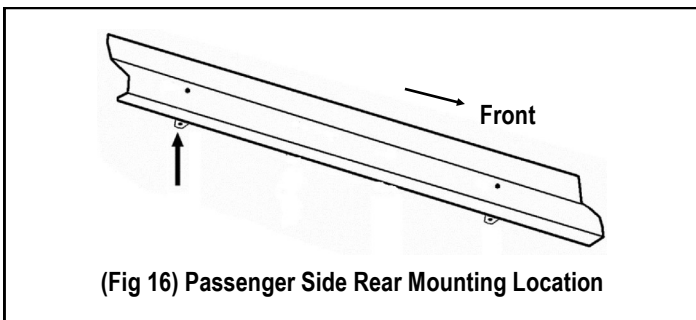

(Fig 17) 2017-Up Passenger Side DEF Cover Marked For Trimming

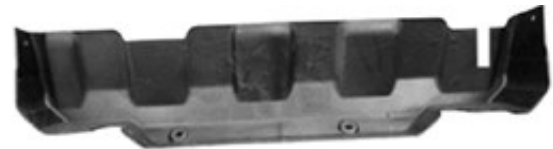

STEP 11

Repeat **Steps 6 or 7** to install the passenger side Running Board installation

STEP 12

Once the Running Board are installed and all hardware fully tightened, reinstall the DEF tank and cover, if equipped, as described in **Step 7**.

The installation is completed!!!

Attention

Do periodic inspections to the installation to make sure that all hardware is secure and tight.

In order to protect your bars/boards, please use only mild soap/non-abrasive products for cleaning.