

iBoard®



Scan for
Installation Video

iBoard® by APS

PART#: IB-133C&H

READ INSTRUCTIONS CAREFULLY BEFORE STARTING INSTALLATION. REMOVE CONTENTS FROM BOX AND VERIFY ALL PARTS ARE PRESENT. ASSISTANCE IS RECOMMENDED.

*ROCKER PANEL MOUNT
*NO DRILLING REQUIRED

Fastener Size	Tightening Torque (ft-lbs)	Required
6mm	6-7	X
8mm	16-18	√
10mm	31-32	√
12mm	56-58	X
14mm	92-94	X

PART LIST

Driver Side Step Bar

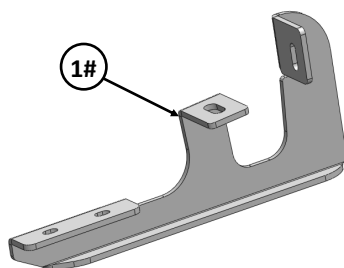
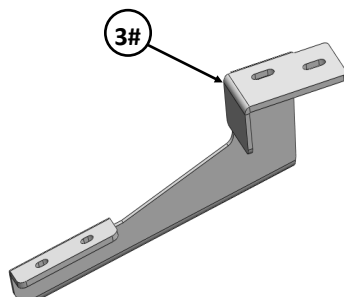
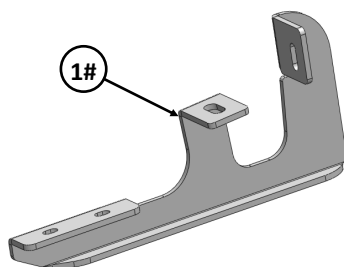

Front



Passenger Side Step Bar

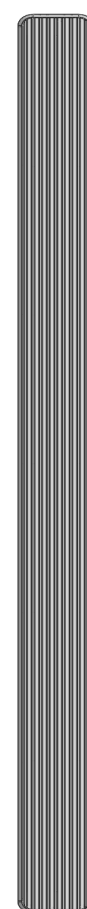
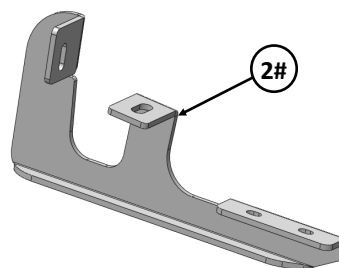
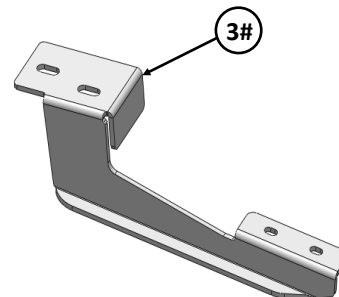
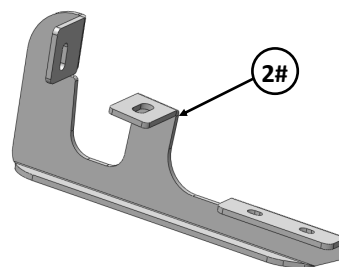



Mounting Bracket List					
Item	QTY	Description	Item	QTY	Description
1#	2	Driver Front / Rear Mounting Brackets	3#	2	Driver / Passenger Center Mounting Brackets
2#	2	Passenger Front / Rear Mounting Brackets			

Hardware Package A (For Bracket Installation)					
Item	QTY	Description	Item	QTY	Description
1#	2	M10 Double Nut Plates	6#	8	M10 Lock Washers
2#	4	M10 Bolt / M8 Nut Plates	7#	4	M10 Hex Nuts
3#	4	M10 Plastic Washer	8#	4	M8X1.25-30mm Hex Bolts
4#	4	M10X1.5-35mm Hex Bolts	9#	4	M8 Large Flat Washers
5#	8	M10 Large Flat Washers	10#	4	M8 Lock Washers

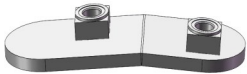

1 #

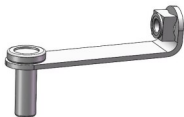

2 #



3 #

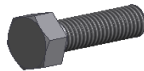

4 #



5 #



6 #



7 #

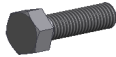

8 #



9 #



10 #

Hardware Package B (For Stainless Steel Step Bar Installation)					
Item	QTY	Description	Item	QTY	Description
1#	12	M8X1.25-35mm Carriage Bolts	3#	12	M8 Nylon Lock Nuts
2#	12	M8 Large Flat Washers	4#	6	Sliders (Packed with Step Bars)

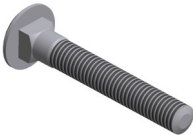

1 #



2 #



3 #

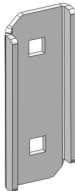

4 #



STEP 1

Start installation from the driver side. Locate the factory holes in the bottom and inside of the floor panel towards the front tire opening, (Fig 1).

IMPORTANT: On some vehicles, the body panel may be filled with expanding foam insulation. Use a long flat blade screwdriver or heavy wire, (coat hanger for example), to dig out the foam to provide clearance for the Bolt / Nut Plates, (Fig 2).

Use These (2) Holes. Remove
Foam As Necessary

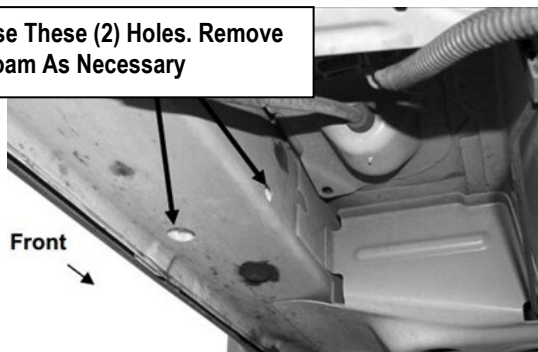

(Fig 1) Driver Side Front Mounting Location

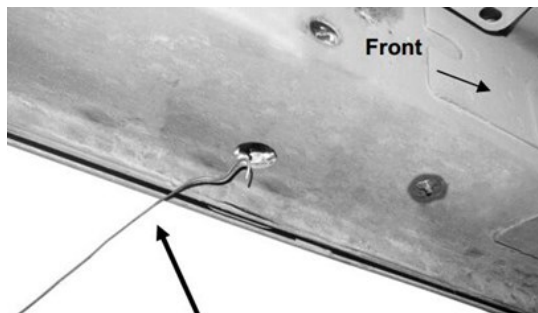

(Fig 2) Use Wire To Pull out The Foam From Mounting holes on The Floor Panel

STEP 2

Select (1) M10 Bolt / M8 Nut Plate. Insert the bent end with the 8mm nut into the hole in the bottom of the floor panel, (Fig 3). Line up the hex nut with the hole in the side of the floor panel. Thread (1) M10 Plastic Washer onto the M10 Bolt end of the Bolt /Nut Plate, (Fig 3).

NOTE: The Plastic Washer is provided to help hold the Bolt / Nut Plate in position during Bracket installation.

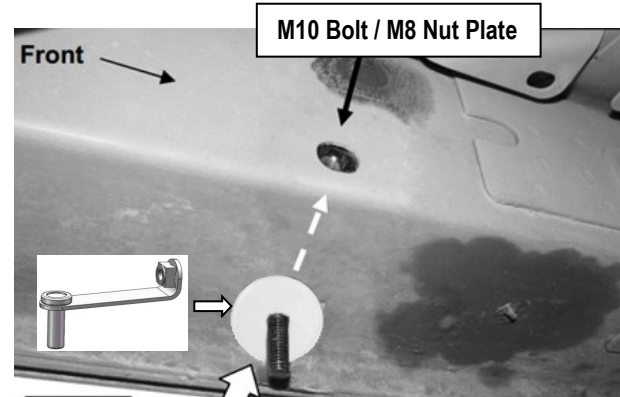

(Fig 3) M10 Bolt / M8 Nut Plate Installation

STEP 3

Select (1) Driver Front Mounting Bracket. Position the Bracket up to the vehicle and over the previously installed M10 Bolt / M8 Nut Plate, (Fig 4). Attach the Bracket to the Bolt /Nut Plate with (1) M10 Large Flat Washer, (1) M10 Lock Washer and (1) M10 Hex Nut. Attach the Bracket to the M8 Nut with (1) M8X1.25-30mm Hex Bolt, (1) M8 Lock Washer and (1) M8 Large Flat Washer. Do not fully tighten hardware at this time.

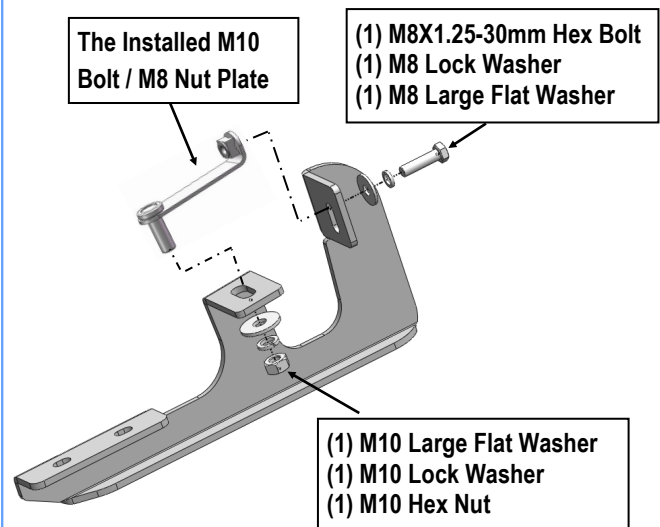

(Fig 4) Driver Front Mounting Bracket Installation



STEP 4

Move along the floor panel to the center of the vehicle, (Fig 5). Select (1) M10 Double Nut Plate, (Fig 6A). Insert the M10 Double Nut Plate into the large hole in the floor panel reinforcement, (Fig 6). Line up the threaded hole with the single small hole in the reinforcement, (Fig 7).

NOTE: The M10 Double Nut Plate is offset to line up with the offset holes in the floor panel reinforcement.



(Fig 5) Driver Side Center Mounting Location

Line Up Offset Hole In Nut Plate With Single Small Hole

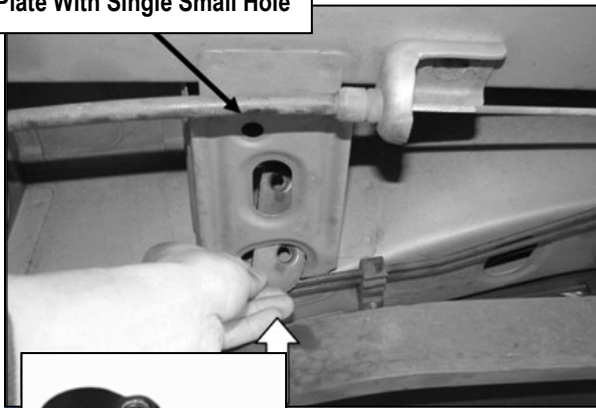
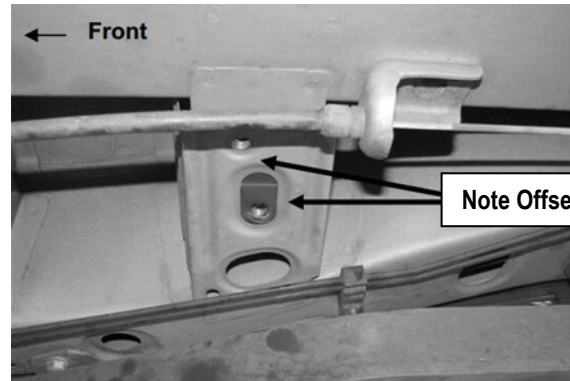

Fig 6A

M10 Double Nut Plate

(Fig 6) M10 Double Nut Plate Installation
(on Driver Side Center Mounting Location)



(Fig 7) M10 Double Nut Plate Installed
(on Driver Side Center Mounting Location)

STEP 5

Select (1) Driver Center Mounting Bracket. Line up the (2) holes in the Center Bracket with the Double Nut Plate. Bolt the Bracket to the installed Double Nut Plate with (2) M10X1.5-35mm Hex Bolts, (2) M10 Lock Washers and (2) M10 Flat Washers, (Fig 8). Do not fully tighten hardware at this time.

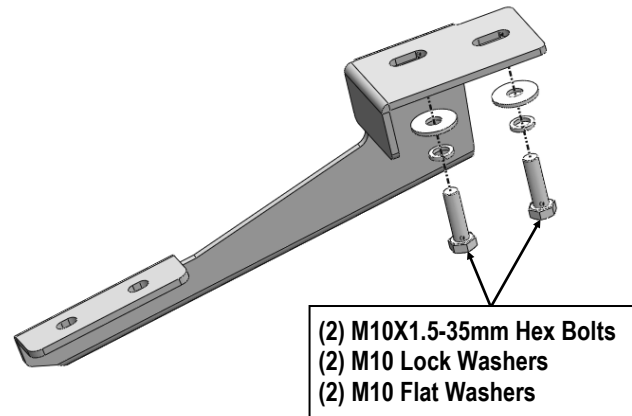

(Fig 8) Driver Center Mounting Bracket Installation



STEP 6

Continue along the floor panel toward the rear of the vehicle. Locate the round hole at the bottom of the floor panel as described in **Step 1, (Fig 9)**. Repeat **Steps 2–3** to install the Driver Rear Mounting Bracket in the rear location.

Note: Driver Front Mounting Bracket and Driver Rear Mounting Bracket are universal.



(Fig 9) Driver Side Rear Mounting Location

Level and adjust the Step Bar and fully tighten all hardware.

Repeat **Steps 1-7** for the other side Step Bar installation. **The installation is completed!!!**

Attention

Do periodic inspections to the installation to make sure that all hardware is secure and tight.

In order to protect your bars/boards, please use mild soap/non-abrasive products for cleaning only.

STEP 7

Once all (3) Driver side mounting brackets are installed, then proceed to the Step Bar installation. (**Figs 10& 11**)

- (1) Select (1) Slider and (2) M8X1.25-35mm Carriage Bolts;
- (2) Install (2) M8X1.25-35mm Carriage Bolts in (1) Slider.
- (3) Slide the Slider (with carriage bolts) to the **Step Bar**.
- (4) Repeat to install the other (2) sliders to the step bar.
- (5) Attach the Step Bar (with the Sliders) onto the installed mounting brackets. Position the Sliders to the installed brackets. Secure the Step Bar to the installed Brackets by using (6) M8 Large Flat Washers and (6) M8 Nylon Lock Nuts and (3) Sliders, (**Fig 11**). Do not fully tighten hardware at this time.

Note: The Sliders are packed with the Step Bars.



Scan for
Installation Video

