

iBoard®

iBoard® by APS

PART#: IB-410

READ INSTRUCTIONS CAREFULLY BEFORE STARTING INSTALLATION. REMOVE CONTENTS FROM BOX AND VERIFY ALL PARTS ARE PRESENT. ASSISTANCE IS RECOMMENDED.

*ROCKER PANEL MOUNT
*DRILLING IS REQUIRED

Fastener Size	Tightening Torque (ft-lbs)	Required
6mm	6-7	√
8mm	16-18	√
10mm	31-32	√
12mm	56-58	X
14mm	92-94	X

PART LIST

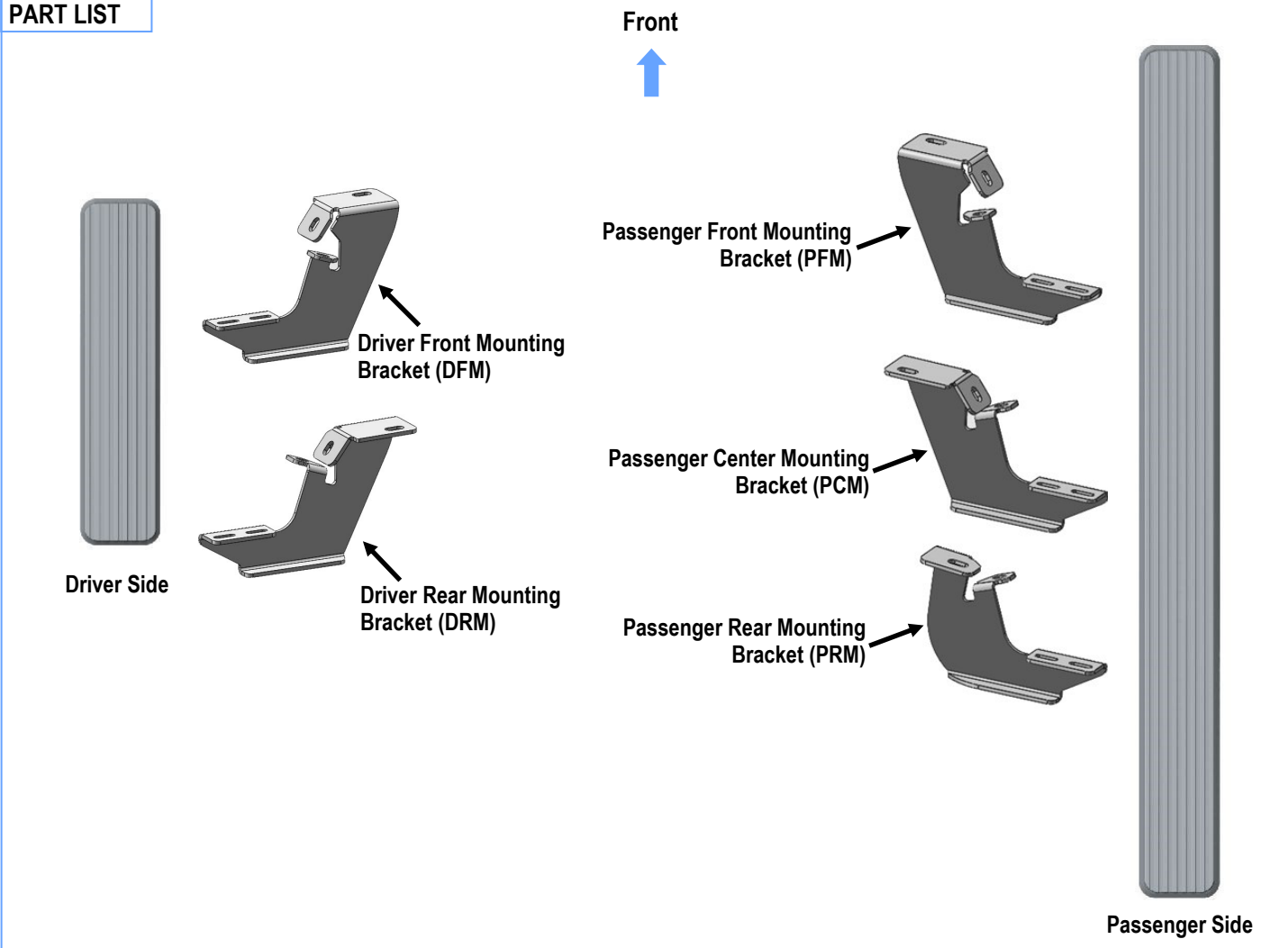

Customer Support: info@iboardauto.com

iBoard®

Hardware Package A (For Bracket Installation)

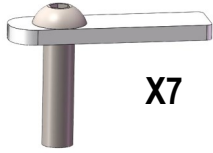

X7

M10 Bolt Plate

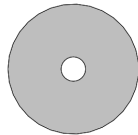

X7

M10 Plastic Washer



X7

M10 Flat Washer



X7

M10 Lock Washer

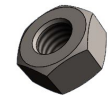

X7

M10X1.5 Hex Nut

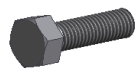

X5

M8X1.25-30mm Hex Bolt



X10

M8 Flat Washer



X5

M8X1.25 Nylon Lock Nut

Hardware Package B (For Aluminum Step Bar Installation Only, Not Supply to Stainless Steel Step Bar)

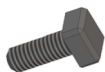

X10

M6X1-20mm Square Head Bolt



X10

M6 Large Flat Washer



X10

M6X1 Nylon Lock Nut

Hardware Package C (For Stainless Steel Step Bar Installation Only, Not Supply to Aluminum Step Bar)

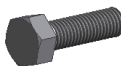

X10

M6X1-20mm Hex Bolt



X10

M6 Lock Washer



X10

M6 Flat Washer

STEP 1

Starting installation from the driver side front of the vehicle. Locate and remove (1) rubber plug closest to the front tire opening, (Fig 1). Select (1) M10 Bolt Plate and (1) M10 Plastic Washer. Partially thread the M10 Plastic Washer onto the M10 Bolt Plate. Insert the M10 Bolt Plate into the opening and thread the M10 Plastic Washer down tight, (Fig 2).

NOTE: The M10 Plastic Washer is designed to help hold the M10 Bolt Plate in place during Bracket installation but is not required for installation.

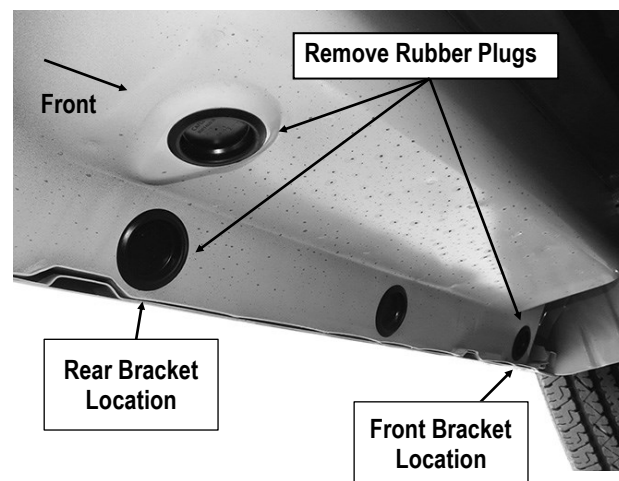

(Fig 1) Driver Side Mounting Bracket Locations

iBoard®

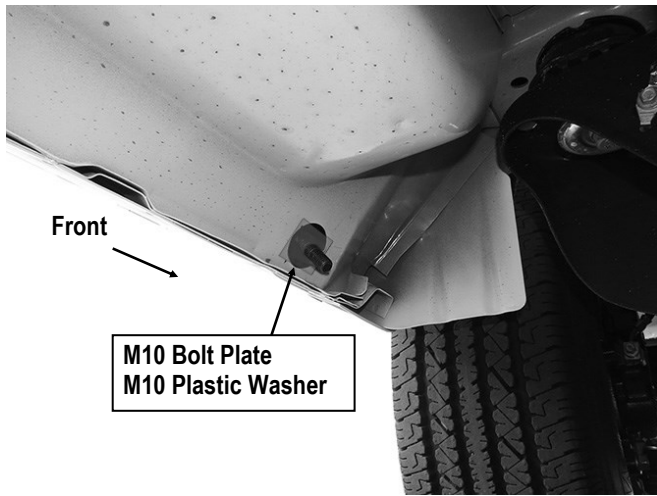

(Fig 2) Insert M10 Bolt Plate Into Factory Holes

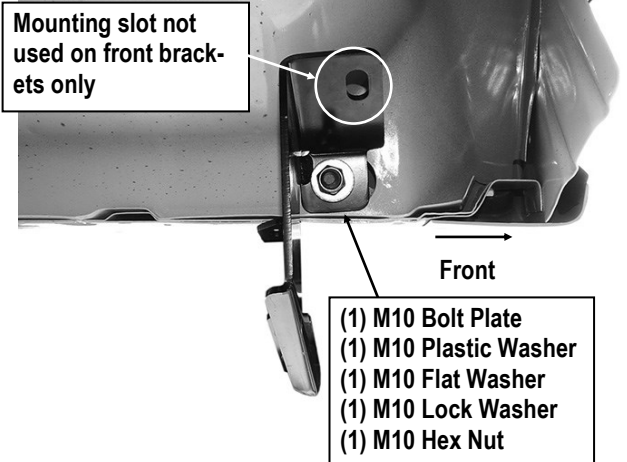

(Fig 4) Driver Front Mounting Bracket (DFM) Installation

STEP 2

Select the Driver Front Mounting Bracket (DFM). Attach the Bracket to the M10 Bolt Plate with (1) M10 Flat Washer, (1) M10 Lock Washer and (1) M10 Hex Nut, (Fig 3 & 4). Do not fully tighten the hardware at this time.

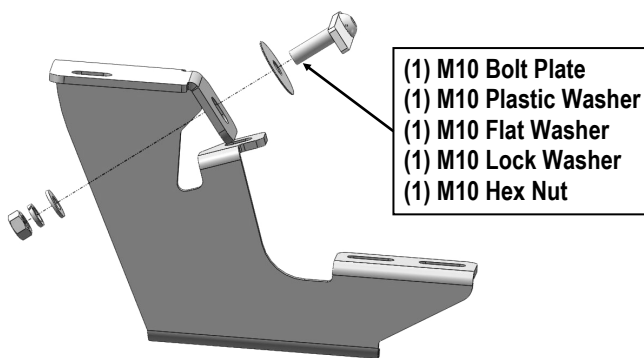

(Fig 3) Driver Front Mounting Bracket (DFM) Installation

STEP 3

Move to the driver side rear of the vehicle, (Fig 1). Locate and remove the (2) rubber plugs. Insert (2) M10 Bolt Plates into the opening.

Repeat **Steps 1 & 2** to attach the Driver Rear Mounting Bracket (DRM) to the (2) M10 Bolt Plates, (Fig 5). Do not fully tighten hardware at this time.

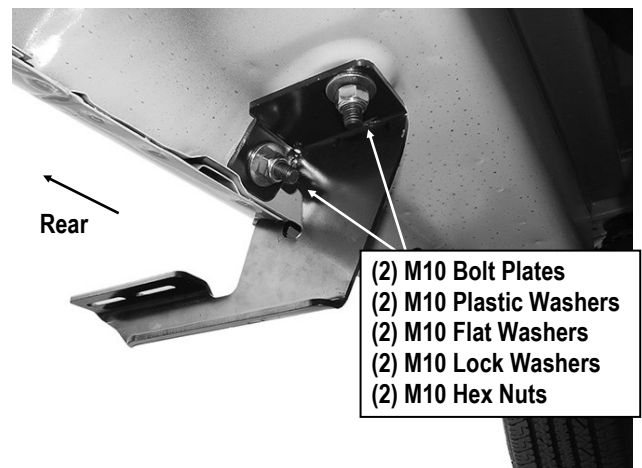

(Fig 5) Driver Rear Mounting Bracket (DRM) Installation

iBoard®

STEP 4

Once all (2) mounting brackets are installed, then proceed to the Step Bar installation. According to the style of Step Bar proceed to the correct installation STEPS.

Note: Aluminum Step Bar refer to STEP 5; Stainless Steel Step Bar skip to STEP 6.

STEP 5

Aluminum Step Bar Installation:

Select a **Aluminum Step Bar**. Slip (2) M6x1-20mm Square Head Bolts into each bottom channel (**Fig 6**). Carefully position the Step Bar onto the (2) Mounting Brackets.

IMPORTANT: Do not slide the Step Bar on the Brackets or the bottom surface of the board will be damaged. Attach the Step Bar to each Mounting Brackets with (2) M6x1-20mm Square Head Bolts, (2) M6 Large Flat Washers and (2) M6X1 Nylon Lock Nuts, (**Fig 7**). Do not fully tighten at this time. Level and adjust the Step Bar and fully tighten all hardware. Repeat **Steps 1-5** for the other side Step Bar installation.



(Fig 6) Slip M6X1-20mm Square Head Bolts Into The Bottom Channels

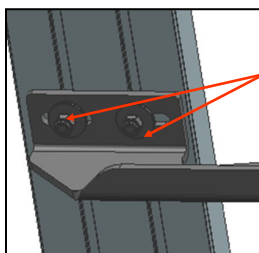

(2) M6X1-20mm Square Head Bolts
(2) M6 Large Flat Washers
(2) M6X1 Nylon Lock Nuts
IMPORTANT: TORQUE FOR 6MM FASTNERS MUST LESS THAN 6-7 FT-LBS OR THE FASTNERS WILL BE DAMAGED!

(Fig 7) Running Board Installed Onto Mounting Bracket

STEP 6

Stainless Steel Step Bar Installation:

Select a **Stainless Steel Step Bar** (with the U-Sliders installed on the Bar). Loose the U-Sliders, reposition the U-Sliders onto the board according to the (2) Installed Mounting Brackets location, (**Fig 8**). Re-secure the U-Sliders on the Step Bar. Attach the Step Bar to the installed Mounting Brackets with (4) M6X1-20mm Hex Bolts, (4) M6 Large Flat Washers & (4) M6 Lock Washers, (**Fig 9**). Do not fully tighten hardware at this time. Level and adjust the Step Bar and fully tighten all hardware. Repeat **Steps 1-4 and 6** for the other side Step Bar installation.

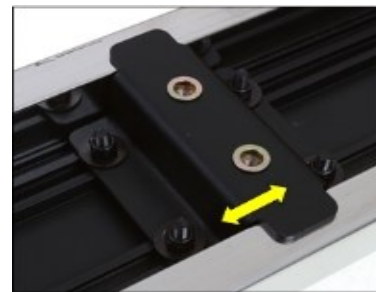

(Fig 8) Slide & line up the U-Slider with the installed mounting brackets along bottom channel

(2) M6X1-20mm Hex Bolts
(2) M6 Large Flat Washers
(2) M6 Lock Washers
IMPORTANT: TORQUE FOR 6MM FASTNERS MUST LESS THAN 6-7 FT-LBS OR THE FASTNERS WILL BE DAMAGED!



(Fig 9) Step Bar Installed on Bracket Installed (Example)

iBoard®

STEP 7

Level and adjust the Running Board and fully tighten all hardware.

Push the Mounting Brackets up tight against the bottom of the body. Use the mounting tab on each Bracket for a guide, mark the location and drill a 5/16" hole through the pinch weld on both Brackets, (Fig 10).

VERY IMPORTANT: Do not drill too close to the edge of the pinch weld, adjust Bracket position as required before drilling through pinch weld.

NOTE: It may be necessary to remove Running Board and Brackets to drill the required holes through the pinch weld. Repeat **Steps 2—8** to reinstall Running Board.

IMPORTANT! Any cutting or drilling tool may break or shatter. Government regulations require safety glasses & equipment at all times when cutting or drilling.

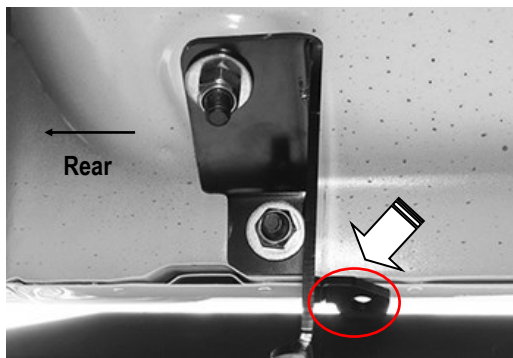

(Fig 10) Drill 5/16" Hole Through Pinch Weld
Do Not Drill Too Close To Edge Of Pinch Weld
(Driver Side Rear Bracket Pictured)

STEP 8

Once both holes have been drilled through the pinch weld, attach the mounting tabs on the (2) Driver Side Mounting Brackets to the pinch weld with (2) M8X1.25-30mm Hex Bolts, (4) M8 Flat Washers and (2) M8 Nylon Lock Nuts, (Figs 11 & 12). Fully tighten hardware at this time.

- (1) M8X1.25-30mm Hex Bolt
- (2) M8 Flat Washers
- (1) M8 Nylon Lock Nut

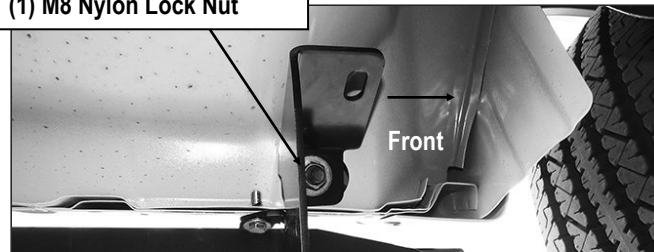

(Fig 11) Attach Driver Front Mounting Bracket To Pinch Weld

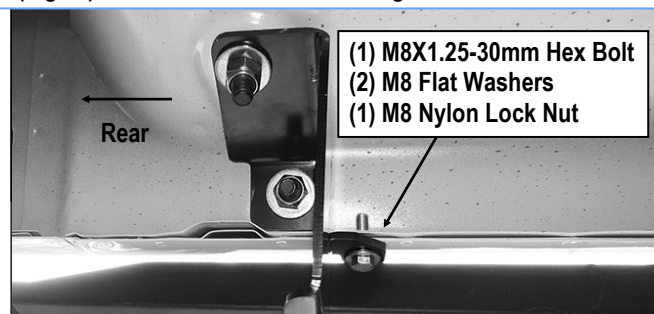

- (1) M8X1.25-30mm Hex Bolt
- (2) M8 Flat Washers
- (1) M8 Nylon Lock Nut

(Fig 12) Attach Driver Rear Mounting Bracket To Pinch Weld

STEP 9

Move to the passenger side front of the vehicle. Locate the rubber plug closest to the front tire opening, (Fig 13). Repeat **Steps 1 & 2** to install the Passenger Front Mounting Bracket (PFM), (Fig 14).

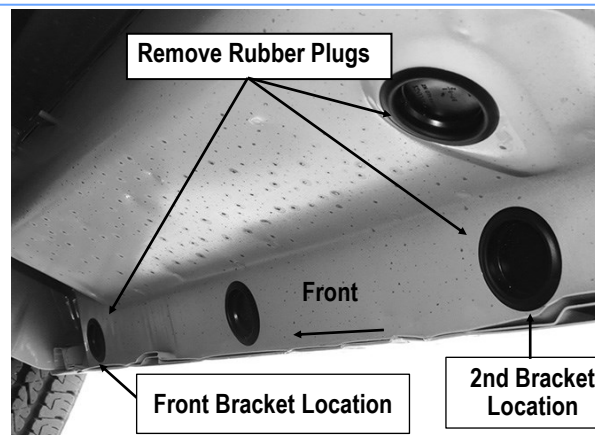

(Fig 13) Passenger Side Front & Center Mounting Bracket Locations

iBoard®

STEP 11

Move along the body to the 3rd bracket location below the side door, (Fig 16). Locate and remove the rubber plug next to the pinch weld.

Select (1) Passenger Rear Mounting Bracket (PRM). Repeat Steps 1-2 to attach the Passenger Rear Mounting Bracket (PRM) to the M10 Bolt Plate in the 3rd location, (Fig 17).

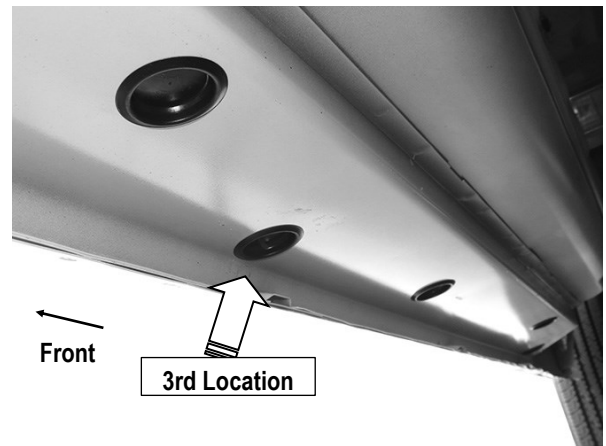

(Fig 16) Passenger Side Rear Mounting Location

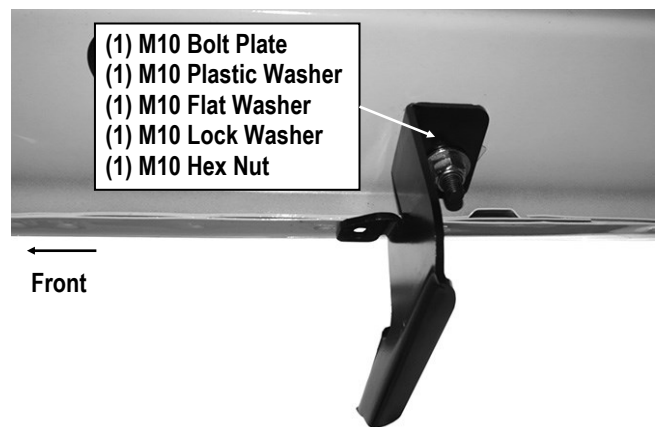

(Fig 17) Passenger Side Rear Mounting Bracket Installation

Mounting slot not used on front brackets only

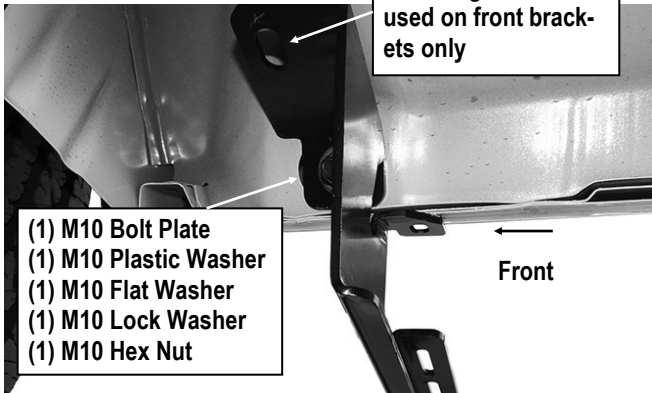

(Fig 14) Passenger Front Mounting Bracket (PFM) Installation

STEP 10

Continue along the body to the (2) rubber plugs identifying the 2nd mounting location, (Fig 13). Repeat Steps 1—3 to install the Passenger Center Mounting Bracket (PCM), (Fig 15).

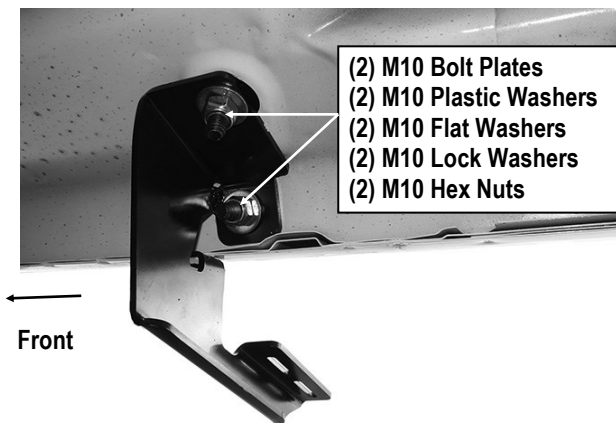

(Fig 15) Passenger Center Mounting Bracket (PCM) Installation

iBoard®

STEP 12

Select the Passenger Side Running Board. Slip (3) M6x1-20mm Square Head Bolts into each bottom channel. Repeat **Step 4** to attach the Running Board to (3) Mounting Brackets. Do not fully tighten hardware at this time.

STEP 13

Repeat **Steps 4—8** to drill and attach the (3) Mounting Brackets to the pinch weld, (**Figs 18—20**).

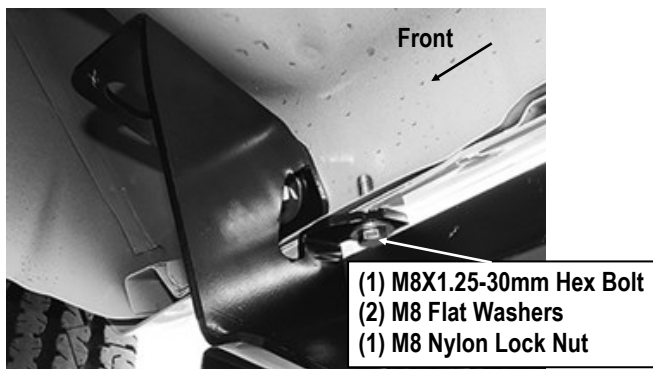

(Fig 18) Attach Passenger Front Mounting Bracket To Pinch Weld



(Fig 19) Attach Passenger Center Mounting Bracket To Pinch Weld



(Fig 20) Attach Passenger Rear Mounting Bracket To Pinch Weld

STEP 14

Level and adjust the Running Board and fully tighten all hardware.

Installation Completed.

Attention

Do periodic inspections to the installation to make sure that all hardware is secure and tight.

In order to protect your bars/boards, please use only mild soap/non-abrasive products for cleaning.