

iArmor[®]

iArmor[®] by APS

PART#: IA-S054H

BEFORE INSTALLATION

REMOVE CONTENTS FROM BOX. VERIFY ALL PARTS ARE PRESENT. READ INSTRUCTIONS CAREFULLY BEFORE STARTING INSTALLATION. ASSISTANCE IS RECOMMENDED. THANK YOU FOR CHOOSING OUR PRODUCT!

*ROCKER PANEL MOUNT

*DRILLING IS REQUIRED/ NO TRIMMING REQUIRED

Fastener Size	Tightening Torque (ft-lbs)	Required
6mm	6-7	√
8mm	16-18	√
10mm	31-32	X
12mm	56-58	X
14mm	92-94	X

PART LIST

Driver Side Step Bar

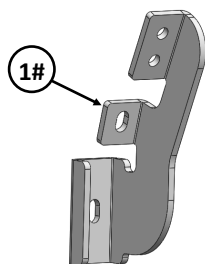
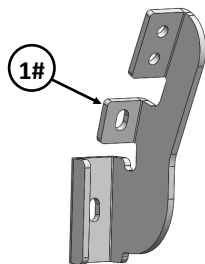
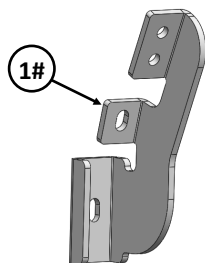
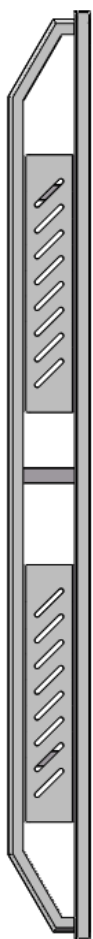

Front



Passenger Side Step Bar

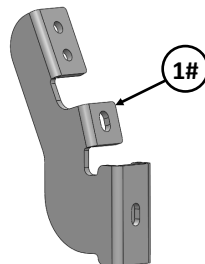
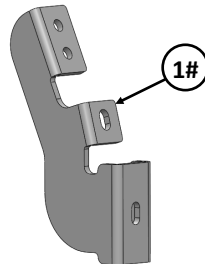
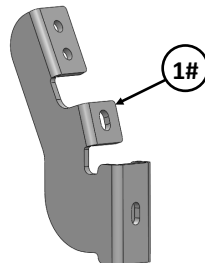
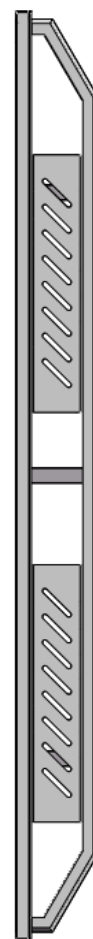



NOTE: All Mounting Brackets Are Universal

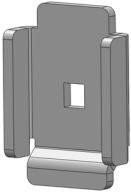
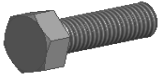

Customer Support: info@iarmorauto.com

iArmor[®]

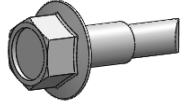
Hardware Package A (For Bracket Installation)					
Item	QTY	Description	Item	QTY	Description
1#	6	Mounting Brackets	4#	12	M8 Flat Washers
2#	6	U Brackets	5#	6	M8X1.25 Nylon Lock Nuts
3#	6	M8X1.25-20mm Hex Bolts	6#	12	ST6.3-22mm Hex Self Tapping Screws

				
2 #	3 #	4 #	5 #	6 #

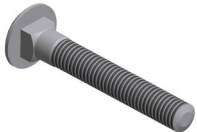
Hardware Package B (For Step Bar Installation)					
Item	QTY	Description	Item	QTY	Description
1#	6	M8X1.25-55mm Carriage Bolts	3#	6	M8 Lock Washers
2#	6	M8 Large Flat Washers	4#	6	M8 Hex Nuts

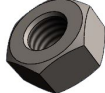
			
1 #	2 #	3 #	4 #

iArmor[®]

The instruction here is for your reference only. We strongly recommend the professional installer for best result. We are not responsible for any damage caused by the installation.

STEP 1

Start from the driver side mounting locations, drill 8mm holes in pinch weld and body panel as shown (Fig 1).

STEP 2

Select (1) Mounting Bracket, attach the Mounting Bracket to the drilled holes on driver side front mounting location with (2) ST6.3-22mm Hex Self Tapping Screws, (1) M8X1.25-20mm Hex Bolt, (2) M8 Flat Washers, (1) M8X1.25 Nylon Lock Nut, (Fig 2). Do not fully tighten hardware at this time.

STEP 3

Repeat **Steps 1-2** for Driver Center & Rear Mounting Brackets installation. Do not fully tighten hardware at this time.

Note: (6) Mounting Brackets are Universal.

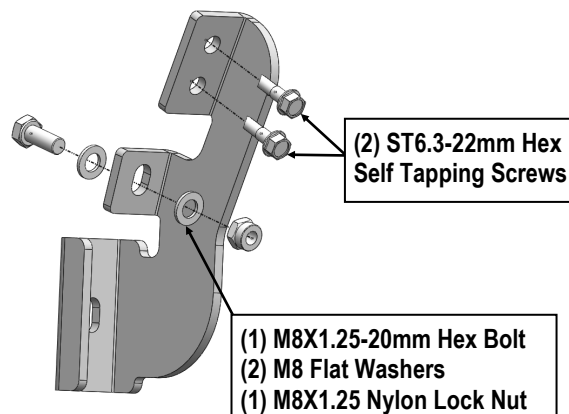

(Fig 2) Driver Front Mounting Bracket Installation

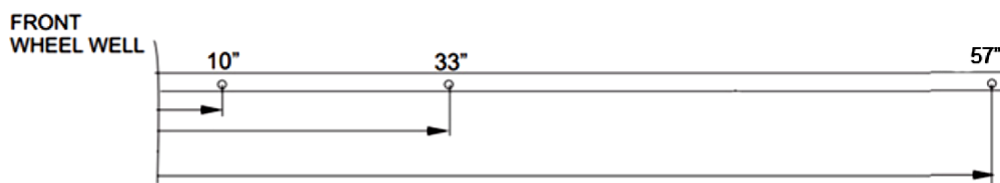
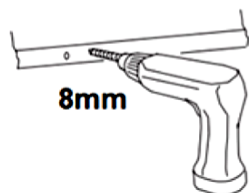

(Fig 1) Driver Side Mounting Locations

iArmor®

STEP 4

Once all (3) driver side mounting brackets are installed, select and attach the Driver Side Step Bar onto the Mounting Brackets with (3) U Brackets, (3) M8X1.25-55mm Carriage Bolts, (3) M8 Large Flat Washers, (3) M8 Lock Washers and (3) M8X1.25 Hex Nuts, (Fig 3). Do not fully tighten hardware at this time.

STEP 5

Properly level and adjust the Step Bar and fully tighten all hardware.

STEP 6

Move to the other side of the vehicle. Repeat **Steps 1-5** to install passenger side step bar.

Installation completed.

Attention

Do periodic inspections to the installation to make sure that all hardware is secure and tight.

In order to protect your bars/boards, please use mild soap/non-abrasive products for cleaning only.

NOTE: Torque all M8 X1.25-55mm Carriage Bolts to 16~18 lb-ft. Don't over tighten, or the square bars will be damaged by the brackets

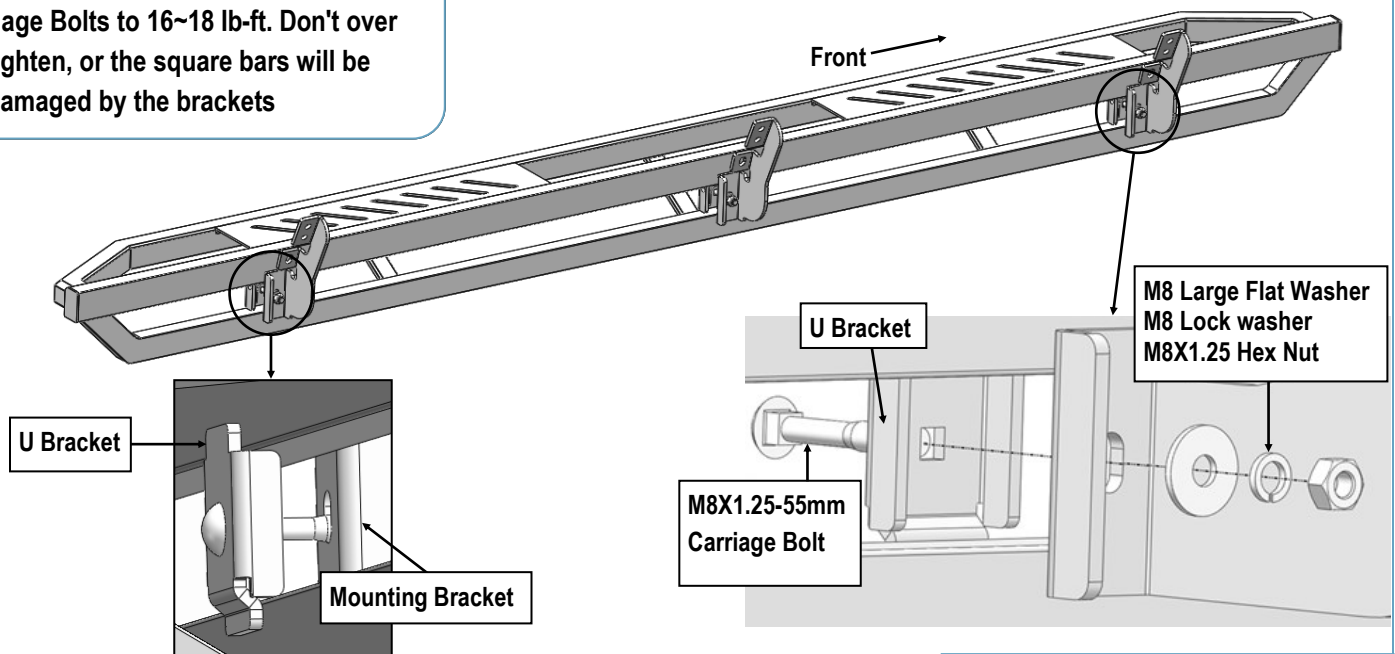

(Fig 3) Driver Side Step Bar Installation