

iArmor[®]

iArmor[®] by APS

PART#: IA-S280H

BEFORE INSTALLATION

REMOVE CONTENTS FROM BOX. VERIFY ALL PARTS ARE PRESENT. READ INSTRUCTIONS CAREFULLY BEFORE STARTING INSTALLATION. ASSISTANCE IS RECOMMENDED. THANK YOU FOR CHOOSING OUR PRODUCT!

***ROCKER PANEL MOUNT**

***NO DRILLING / TRIMMING REQUIRED**

Torque Value

Fastener Size	Tightening Torque (ft-lbs)	Required
6mm	6-7	X
8mm	16-18	√
10mm	31-32	X
12mm	56-58	X
14mm	92-94	X

PART LIST

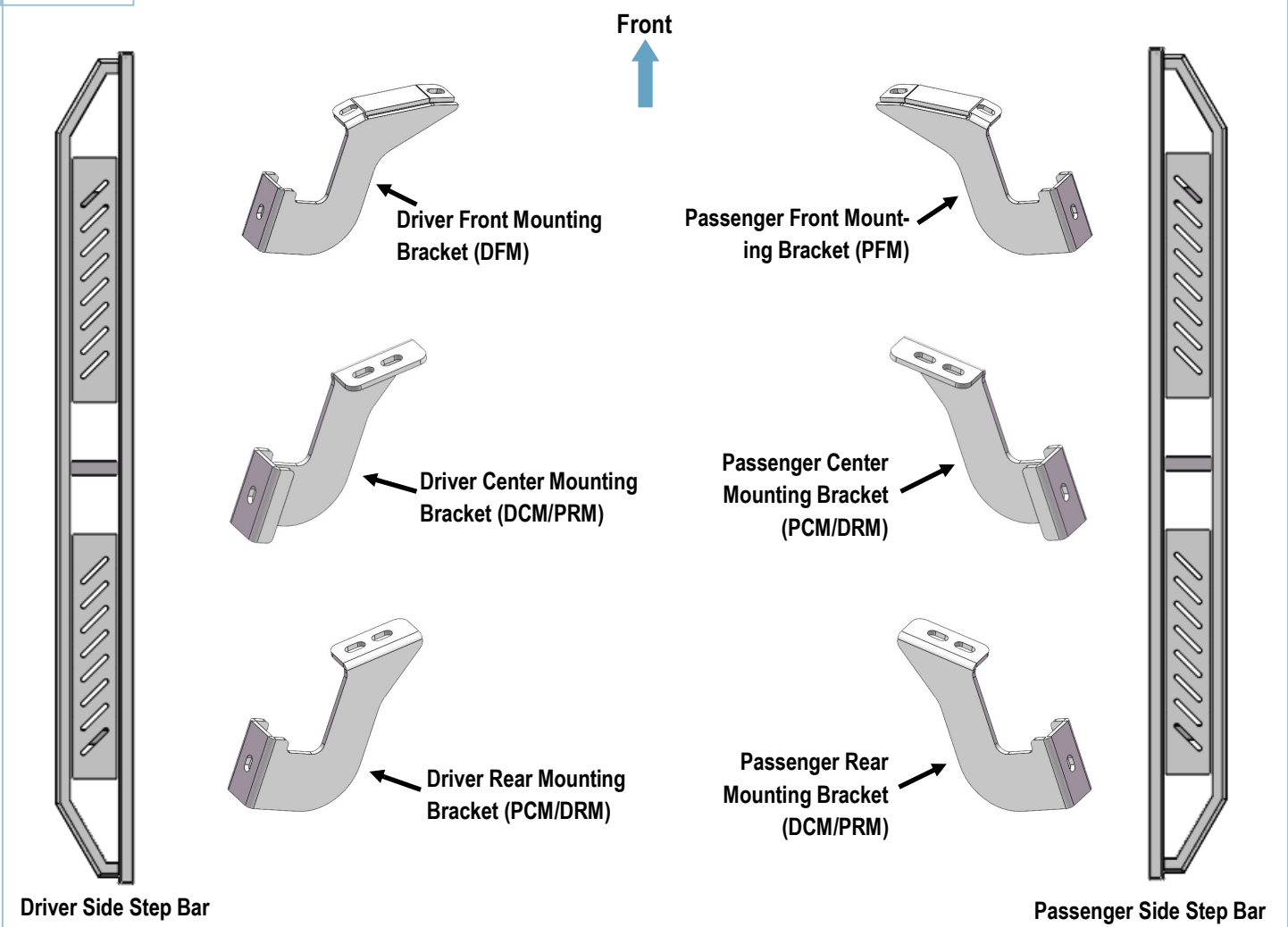

Customer Support: info@iarmorauto.com

iArmor[®]

Hardware Package A (For Bracket Installation)

Item	QTY	Description	Item	QTY	Description
1#	6	U Brackets	3#	12	M8 Large Flat Washers
2#	12	M8X1.25-30 Hex Bolts	4#	12	M8 Lock Washers

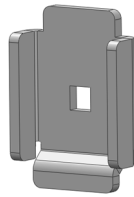

1#

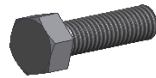

2#



3#



4#

Hardware Package B (For Step Bar Installation)

Item	QTY	Description	Item	QTY	Description
1#	6	M8X1.25-55mm Carriage Bolts	3#	6	M8 Lock Washers
2#	6	M8 Large Flat Washers	4#	6	M8 Hex Nuts

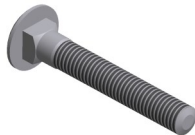

1#



2#



3#

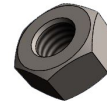

4#

iArmor®

The instruction here is for your reference only. We strongly recommend the professional installer for best result. We are not responsible for any damage caused by the installation.

STEP 1

Start installation on the passenger side of the vehicle, remove the existing (2) factory bolts located by the front tire opening securing the factory rocker panel bracket to the vehicle, (Fig 1).

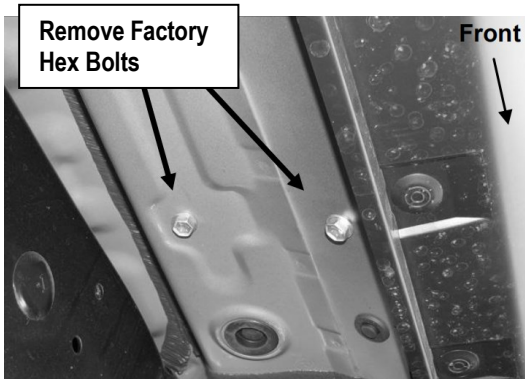

(Fig 1) Passenger Side Front Mounting Location

STEP 2

Select (1) Passenger Front Mounting Bracket (PFM). Hold the Mounting Bracket (PFM) over the rocker panel bracket and line up the (2) mounting holes. Secure the bracket to the vehicle using the included longer (2) M8X1.25-30mm Hex Bolts, (2) M8 Lock Washers and (2) M8 Large Flat Washers, (Fig 2). Do not tighten hardware at this time.



(Fig 2) Passenger Front Mounting Bracket Installation

STEP 3

Move to the passenger side center and rear mounting locations, (Fig 3). Repeat Steps 1-2 to install the Passenger Center Mounting Bracket (PCM/DRM) and Passenger Rear Mounting Bracket (DCM/PRM) (Fig 4). Do not fully tighten hardware at this time.

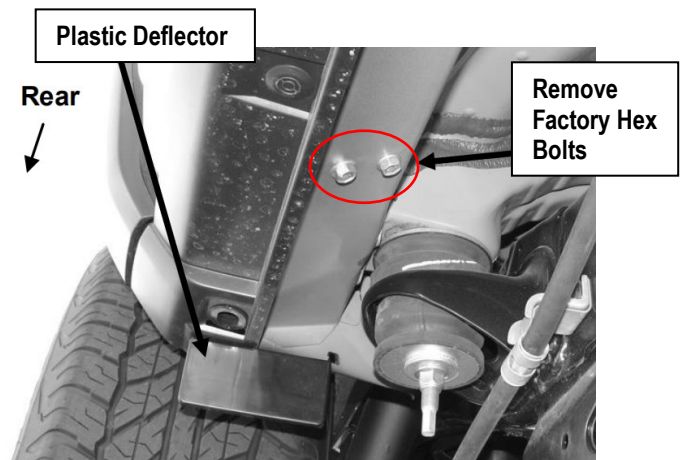

(Fig 3) Passenger Side Rear Mounting Location

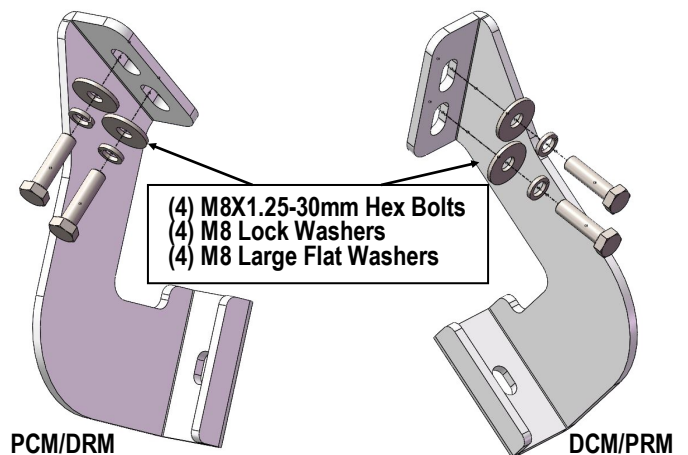

(Fig 4) Passenger Center/ Rear Mounting Bracket Installation

iArmor®

STEP 4

Once all (3) passenger side mounting brackets are installed, select and attach the Passenger Side Step Bar onto the Mounting Brackets with (3) U Brackets, (3) M8X1.25-55mm Carriage Bolts, (3) M8 Large Flat Washers, (3) M8 Lock Washers and (3) M8X1.25 Hex Nuts (**Fig 5**). Do not fully tighten hardware at this time.

STEP 5

Properly level and adjust the Step Bar and fully tighten all hardware.

STEP 6

Move to the driver side of the vehicle. Repeat **Steps 1-5** to install driver side step bar.

Installation completed.

Attention

Do periodic inspections to the installation to make sure that all hardware is secure and tight.

In order to protect your bars/boards, please use mild soap/non-abrasive products for cleaning only.

NOTE: Torque all M8 X1.25-55mm Carriage Bolts to 16~18 lb-ft. Don't over tighten, or the square bars will be damaged by the brackets

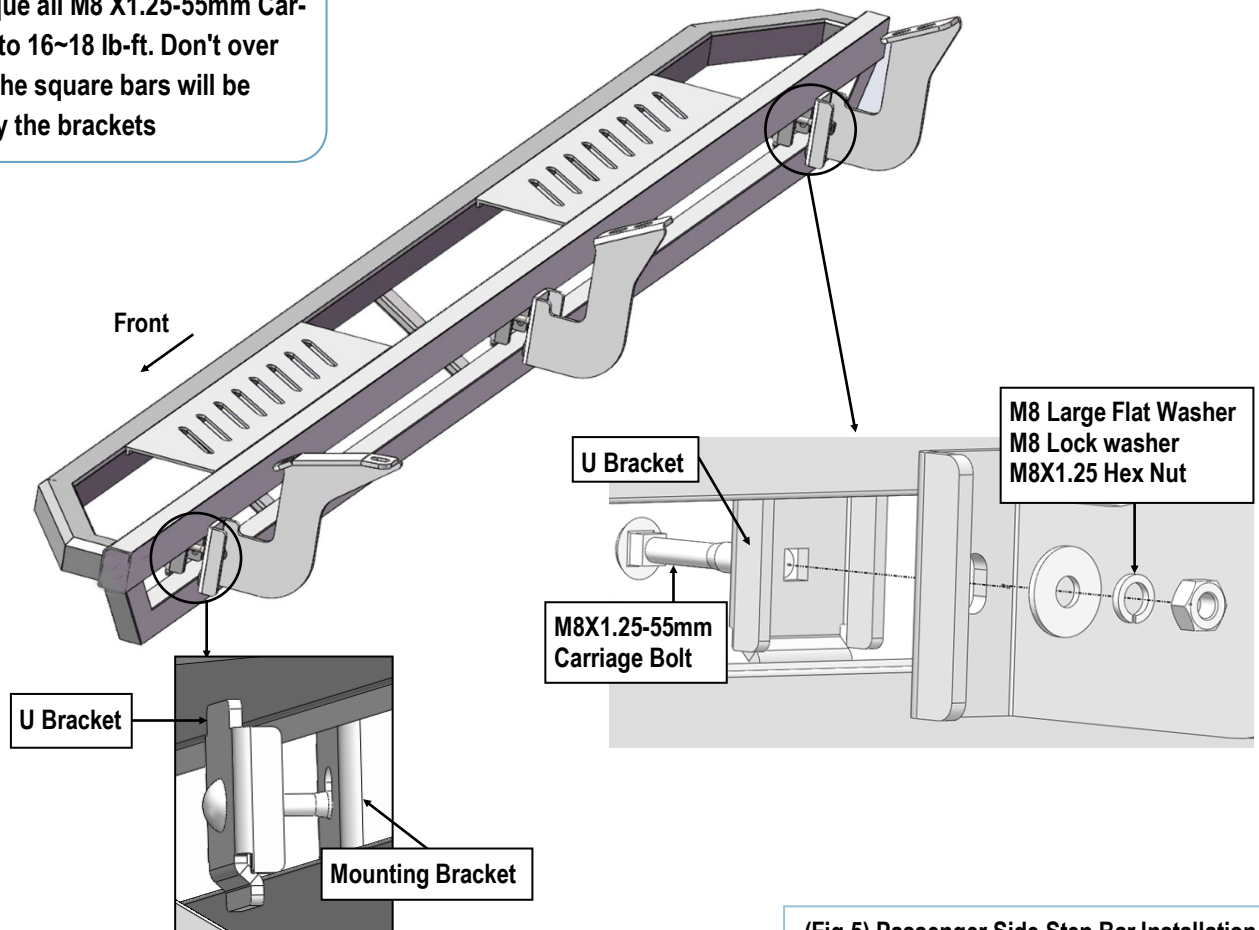

(Fig 5) Passenger Side Step Bar Installation