

iArmor[®]

iArmor[®] by APS

PART#: IA-S923H

BEFORE INSTALLATION

REMOVE CONTENTS FROM BOX. VERIFY ALL PARTS ARE PRESENT. READ INSTRUCTIONS CAREFULLY BEFORE STARTING INSTALLATION. ASSISTANCE IS RECOMMENDED. THANK YOU FOR CHOOSING OUR PRODUCT!

***ROCKER PANEL MOUNT**

***NO DRILLING / TRIMMING REQUIRED**

Torque Value

Fastener Size	Tightening Torque (ft-lbs)	Required
6mm	6-7	X
8mm	16-18	√
10mm	31-32	X
12mm	56-58	X
14mm	92-94	X

PART LIST

Front
↑

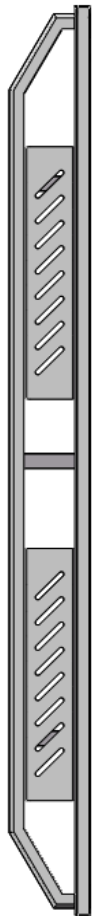

Driver Side Step Bar

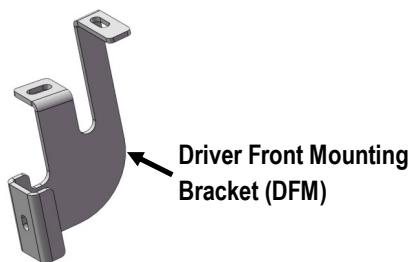

Driver Front Mounting Bracket (DFM)

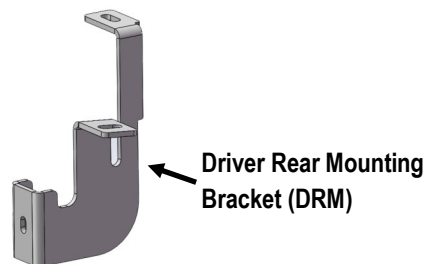

Driver Rear Mounting Bracket (DRM)

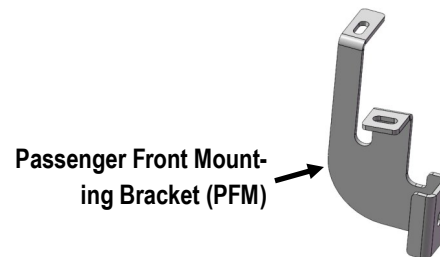

Passenger Front Mounting Bracket (PFM)

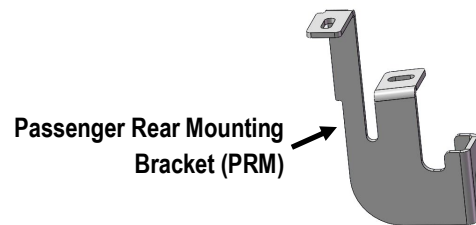

Passenger Rear Mounting Bracket (PRM)

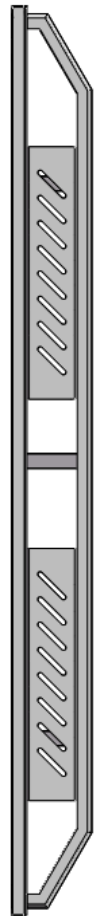



Passenger Side Step Bar

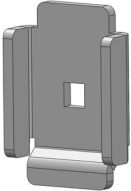
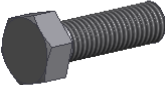

Customer Support: info@iarmorauto.com

iArmor®

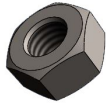
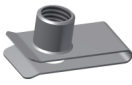
Hardware Package A (For Bracket Installation)					
Item	QTY	Description	Item	QTY	Description
1#	4	U Brackets	4#	8	M8 Lock Washers
2#	8	M8X1.25-25mm Hex Bolts	5#	4	M8X1.25 Hex Nuts
3#	12	M8 Large Flat Washers	6#	4	M8 Clip Nuts

					
1#	2#	3#	4#	5#	6#

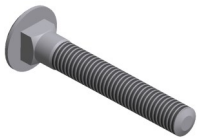
Hardware Package B (For Step Bar Installation)					
Item	QTY	Description	Item	QTY	Description
1#	4	M8X1.25-55mm Carriage Bolts	3#	4	M8 Lock Washers
2#	4	M8 Large Flat Washers	4#	4	M8 Hex Nuts

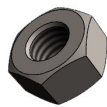
			
1#	2#	3#	4#

iArmor[®]

The instruction here is for your reference only. We strongly recommend the professional installer for best result. We are not responsible for any damage caused by the installation.

STEP 1

Start the installation under the passenger side of the vehicle. Locate the pair of holes on the bottom of the rocker panel and the square hole next to the round hole on the bottom of the floor pan. Insert M8 Clip Nuts through square hole in floor pan so it is positioned over the round hole, **(Fig 1)**.

STEP 2

Select Passenger Front Mounting Bracket (**PFM**). Attach the Mounting Bracket to the rocker panel with (2) M8X1.25-25mm Hex Bolts (3) M8 Large Flat Washers (2) M8 Lock Washers and (1) M8X1.25 Hex Nut **(Fig 2)**. Leave bracket loose at this time.

STEP 3

Move to Passenger Side Rear Mounting Locations. Repeat **Step 2** to install the Mounting Brackets. Leave brackets loose at this time.

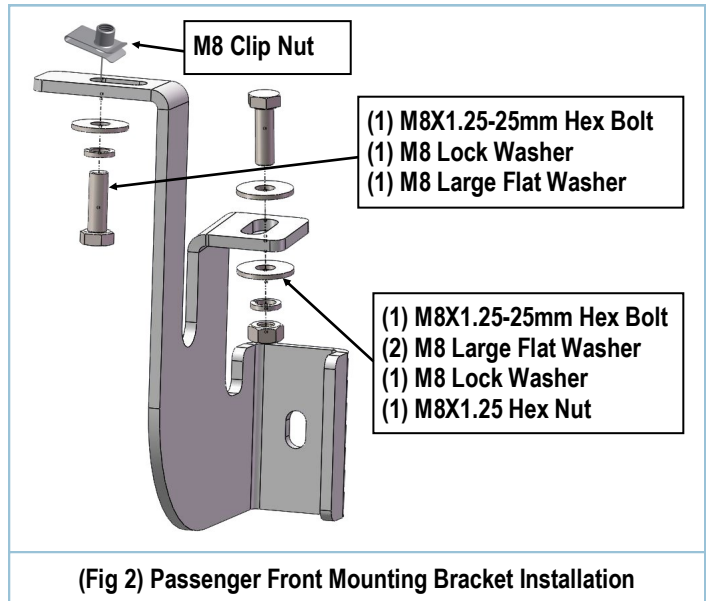

STEP 4

Once all (2) passenger side mounting brackets are installed, select and attach the Passenger Side Step Bar onto the Mounting Brackets with (2) U Brackets, (2) M8X1.25-55mm Carriage Bolts, (2) M8 Large Flat Washers, (2) M8 Lock Washers and (2) M8X1.25 Hex Nuts, **(Fig 3)**. Do not fully tighten hardware at this time.

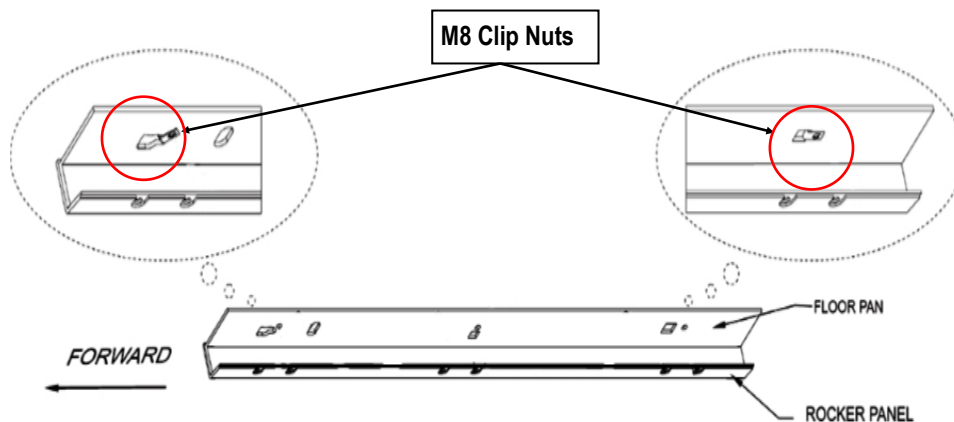

iArmor®

STEP 5

Properly level and adjust the Step Bar and fully tighten all hardware.

STEP 6

Move to the driver side of the vehicle. Repeat **Steps 1-5** to install driver side step bar.

Installation completed.

NOTE: Torque all M8 X1.25-55mm Carriage Bolts to 16~18 lb-ft. Don't over tighten, or the square bars will be damaged by the brackets

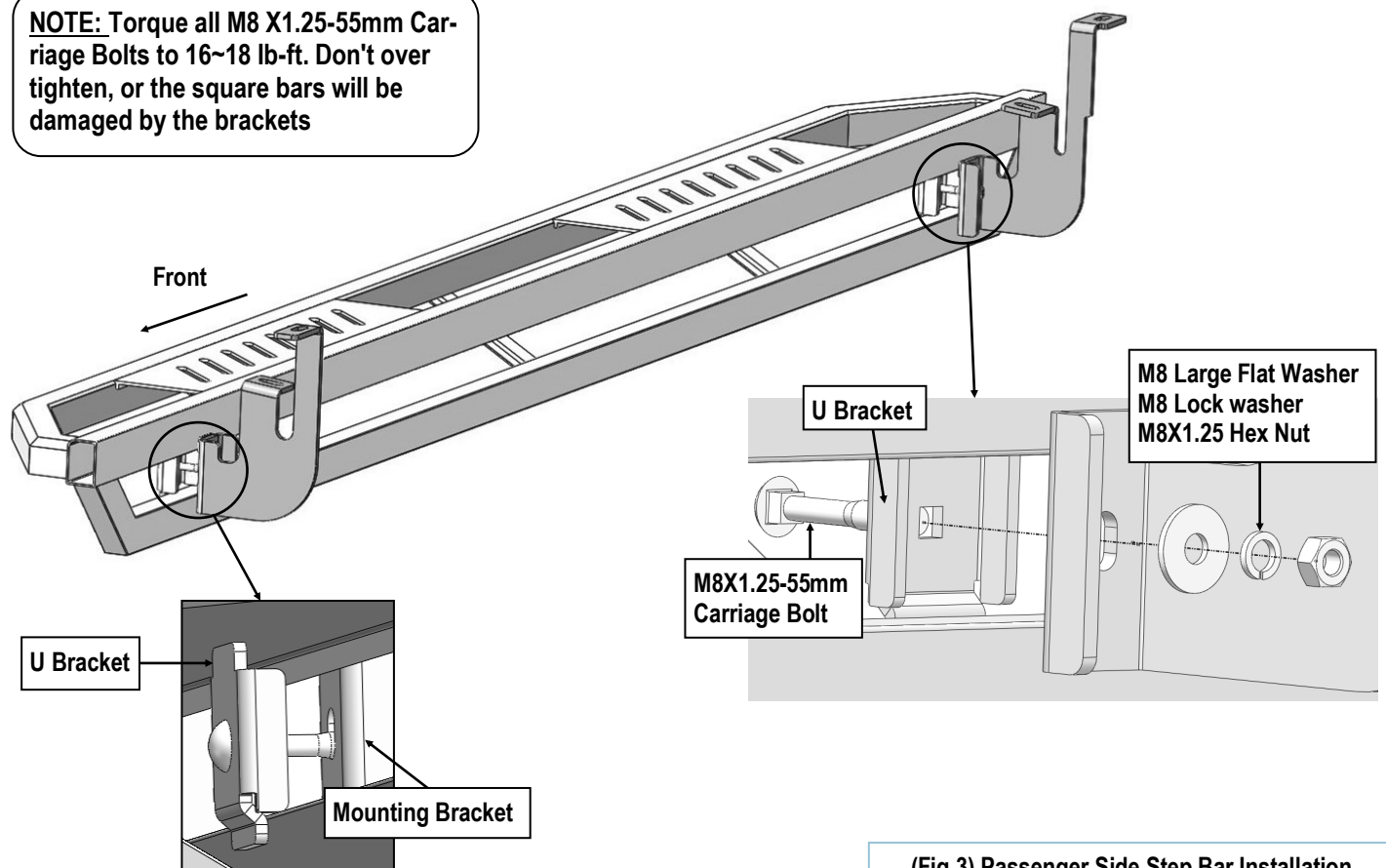

(Fig 3) Passenger Side Step Bar Installation

Attention

Do periodic inspections to the installation to make sure that all hardware is secure and tight.
In order to protect your bars/boards, please use mild soap/non-abrasive products for cleaning only.