

iArmor[®]

iArmor[®] by APS

PART#: IA-S188H

BEFORE INSTALLATION

REMOVE CONTENTS FROM BOX. VERIFY ALL PARTS ARE PRESENT. READ INSTRUCTIONS CAREFULLY BEFORE STARTING INSTALLATION. ASSISTANCE IS RECOMMENDED. THANK YOU FOR CHOOSING OUR PRODUCT!

*ROCKER PANEL MOUNT

*DRILLING NOT REQUIRED

Torque Value

| Fastener Size | Tightening Torque (ft-lbs) | Required |
|---------------|----------------------------|----------|
| 6mm | 6-7 | X |
| 8mm | 16-18 | √ |
| 10mm | 31-32 | X |
| 12mm | 56-58 | X |
| 14mm | 92-94 | X |

PART LIST

Driver Side Step Bar

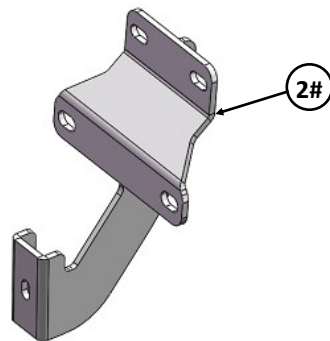
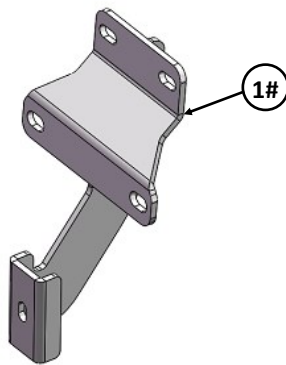
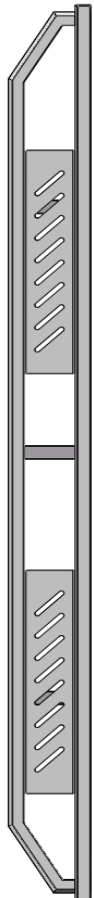

Front



Passenger Side Step Bar

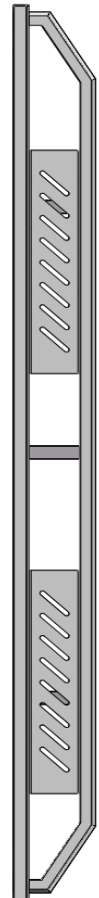
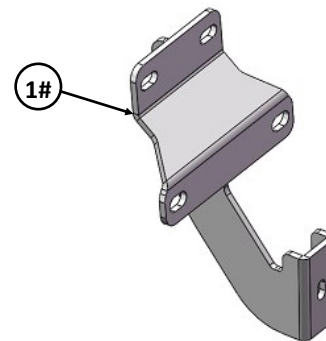
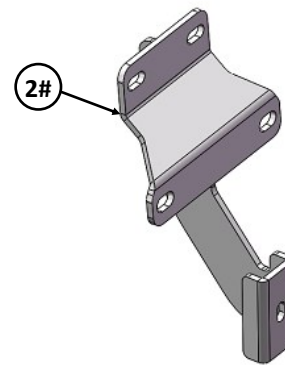

Customer Support: info@iarmorauto.com

iArmor®

| Hardware Package A (For Bracket Installation) | | | | | |
|---|-----|---|------|-----|-------------------------|
| Item | QTY | Description | Item | QTY | Description |
| 1# | 2 | Driver Front & Passenger Rear Mounting Brackets | 4# | 12 | M8 Plastic Washers |
| 2# | 2 | Passenger Front & Driver Rear Mounting Brackets | 5# | 12 | M8 Large Flat Washers |
| 3# | 4 | U Brackets | 6# | 12 | M8X1.25 Nylon Lock Nuts |

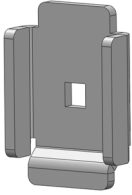

3 #



4 #



5 #



6 #

| Hardware Package B (For Step Bar Installation) | | | | | |
|--|-----|-----------------------------|------|-----|-----------------|
| Item | QTY | Description | Item | QTY | Description |
| 1# | 4 | M8X1.25-55mm Carriage Bolts | 3# | 4 | M8 Lock Washers |
| 2# | 4 | M8 Large Flat Washers | 4# | 4 | M8 Hex Nuts |

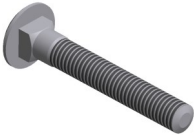

1 #



2#



3 #

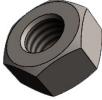

4 #

iArmor®

The instruction here is for your reference only. We strongly recommend the professional installer for best result. We are not responsible for any damage caused by the installation.

STEP 1

Start the installation under the passenger side of the vehicle. Locate the front factory running board mounting location along the inner side of the body, (Fig 1).

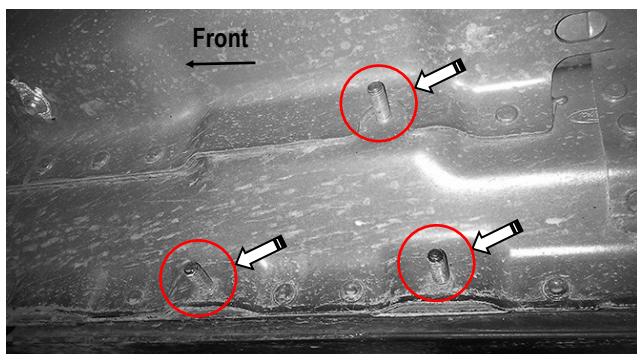

(Fig 1) Passenger Front Mounting Bracket Location

STEP 2

Slide M8 Plastic Washers over each factory mounting stud in the body panel, (Fig 2). **IMPORTANT:** The Plastic Washers are designed to prevent corrosion between the aluminum body panel and the steel mounting brackets.

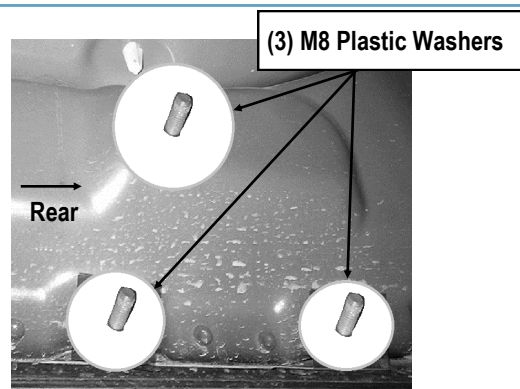

(Fig 2) Thread Plastic Washers Onto 3 Mounting Studs. Passenger Side Front Mounting Location Pictured

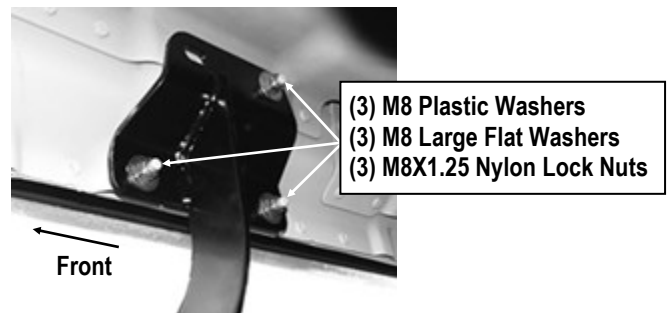

(Fig 3) Passenger Front Mounting Bracket Installed

STEP 3

Select Passenger Front Mounting Bracket. **Note: Passenger Front Mounting Bracket and Driver Rear Mounting Bracket are Universal.** Attach the Mounting Bracket to the (3) factory studs with (3) M8 Large Flat Washers and (3) M8X1.25 Nylon Lock Nuts, (Fig 3). Snug but do not fully tighten the hardware.

STEP 4

Repeat **Steps 1-3** to install the Passenger Rear Mounting Bracket.

STEP 5

Once all (2) passenger side mounting brackets are installed, select and attach the Passenger Side Step Bar onto the Mounting Brackets with (2) U Brackets, (2) M8X1.25-55mm Carriage Bolts, (2) M8 Large Flat Washers, (2) M8 Lock Washers and (2) M8X1.25 Hex Nuts, (Fig 4). Do not fully tighten hardware at this time.

iArmor[®]

STEP 6

Properly level and adjust the Step Bar and fully tighten all hardware.

STEP 7

Move to the passenger side of the vehicle. Repeat **Steps 1-6** to install the passenger side step bar.

Installation completed.

NOTE: Torque all M8 X1.25-55mm Carriage Bolts to 16~18 lb-ft. Don't over tighten, or the square bars will be damaged by the brackets

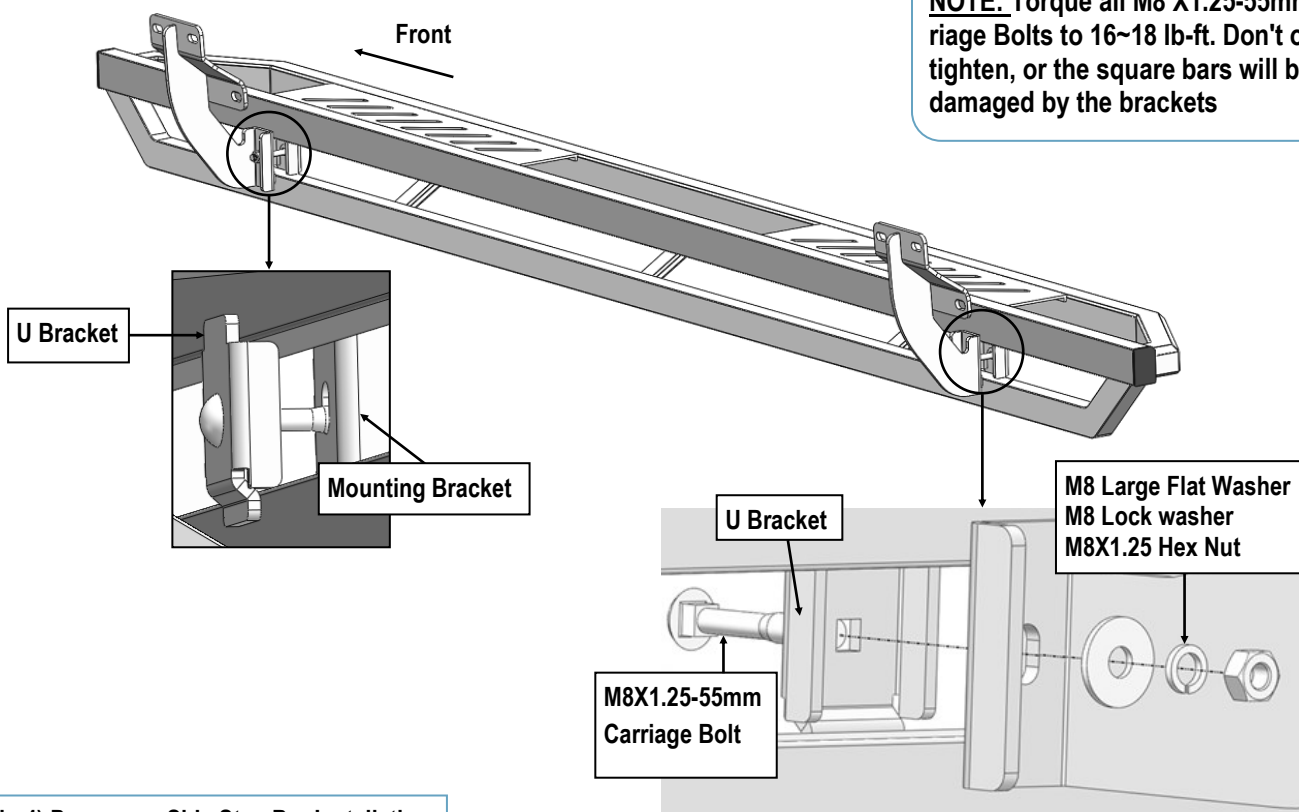

(Fig 4) Passenger Side Step Bar Installation

Attention

Do periodic inspections to the installation to make sure that all hardware is secure and tight.
In order to protect your bars/boards, please use mild soap/non-abrasive products for cleaning only.