

IARMOR EDGE™

PART#: IA-N925

BEFORE INSTALLATION

REMOVE CONTENTS FROM BOX. VERIFY ALL PARTS ARE PRESENT. READ INSTRUCTIONS CAREFULLY BEFORE STARTING INSTALLATION. ASSISTANCE IS RECOMMENDED. THANK YOU FOR CHOOSING OUR PRODUCT!

*DRILLING NOT REQUIRED

*TRIMMING NOT REQUIRED

Torque Value





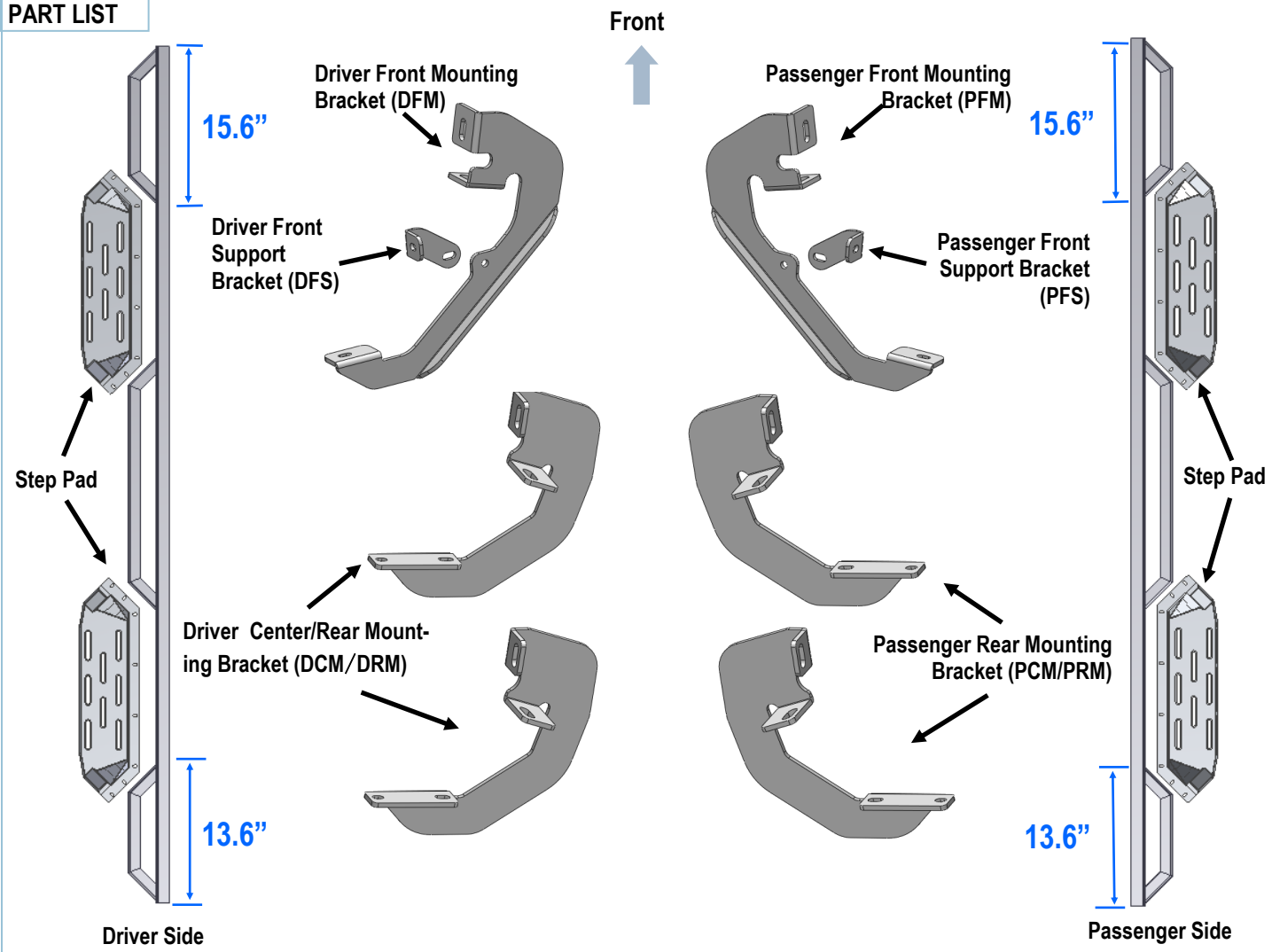

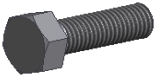

Fastener Size	Tightening Torque (ft-lbs)	Required
6mm	6-7	√
8mm	16-18	√
10mm	31-32	X
12mm	56-58	X
14mm	92-94	X

PART LIST

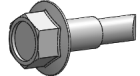
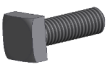

iArmor®

Hardware Package					
Item	QTY	Description	Item	QTY	Description
1#	14	M8X1.25-25mm Hex Bolts	6#	4	M6X1-20mm Square Head Bolts
2#	22	M8 Large Flat Washers	7#	40	M6X1-20mm T-Bolts
3#	14	M8 Lock Washers	8#	44	M6 Large Flat Washers
4#	8	M8 Hex Nuts	9#	44	M6 Nylon Lock Nuts
5#	6	ST8x25mm Hex Self Tapping Screws			

								
1#	2#	3#	4#	5#	6#	7#	8#	9#

iArmor®

The instruction here is for your reference only. We strongly recommend the professional installer for best result. We are not responsible for any damage caused by the installation.

STEP 1

Install the Step Pads onto the step bars with (32) M6X1-20mm T-Bolts, (32) M6 Large Flat Washers and (32) M6 Nylon Lock Nuts.

IMPORTANT: Don't hit the step pad by any metal hammer within step pad installation, or the step pad will be damaged.

(8) M6X1-20mm T-Bolts
(8) M6 Flat Washers
(8) M6 Nylon Lock Nuts

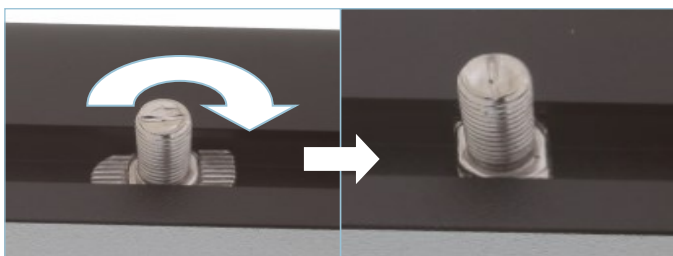

Note: Rotate 90° after inserting the T-Bolts into the Channel!!!

STEP 2

Assemble Passenger Front Mounting Bracket (PFM) and Passenger Front Support Bracket (PFS) with (1) M8X1.25-25mm Hex Bolt, (2) M8 Large Flat Washers, (1) M8 Lock Washer and (1) M8 Hex Nut, (Fig 1). Do not fully tighten hardware at this time.

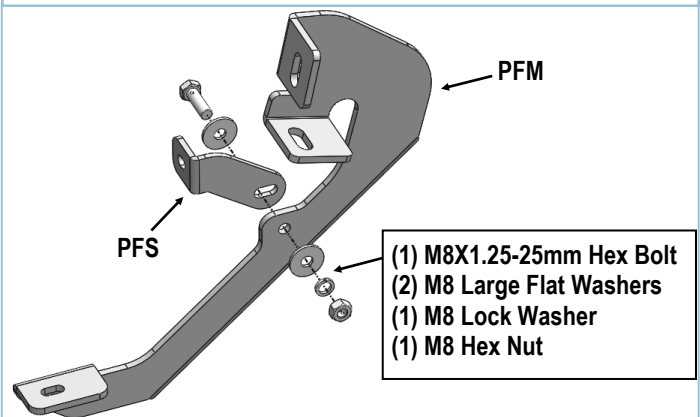

(Fig 1) Passenger Front Mounting Bracket Assembly

STEP 3

Start the installation from the Passenger Side of the vehicle. Identify the mounting locations along the inner side of the rocker panel, remove any tape on the inside of rocker panel that covers the mounting holes, (Fig 2).

NOTE: Use (1) ST8x25mm Hex Self Tapping Screw to replace (1) M8X1.25-25mm Hex Bolt if the upper mounting factory holes are without thread, (Fig 3).

Secure the lower mounting holes on passenger side (2) mounting brackets to underside of rocker panel as shown on Fig 3. Do not fully tighten hardware at this time.

Repeat to install Passenger Center Bracket (PCM) and Passenger Rear Bracket (PRM) to the rocker panel.

iArmor®

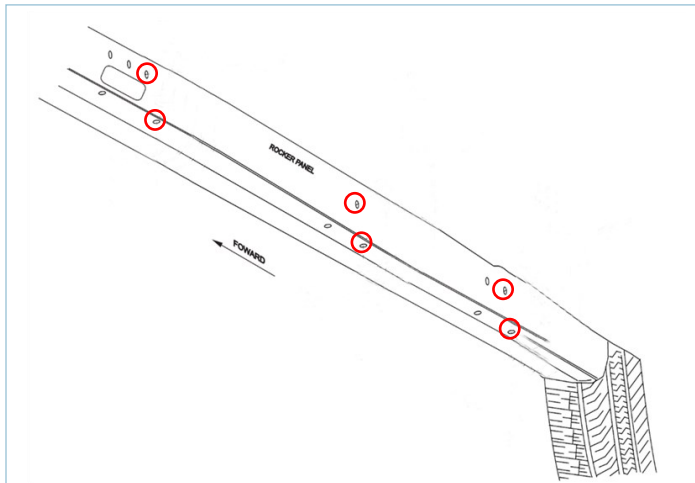

(Fig 2) Passenger Side Mounting Locations

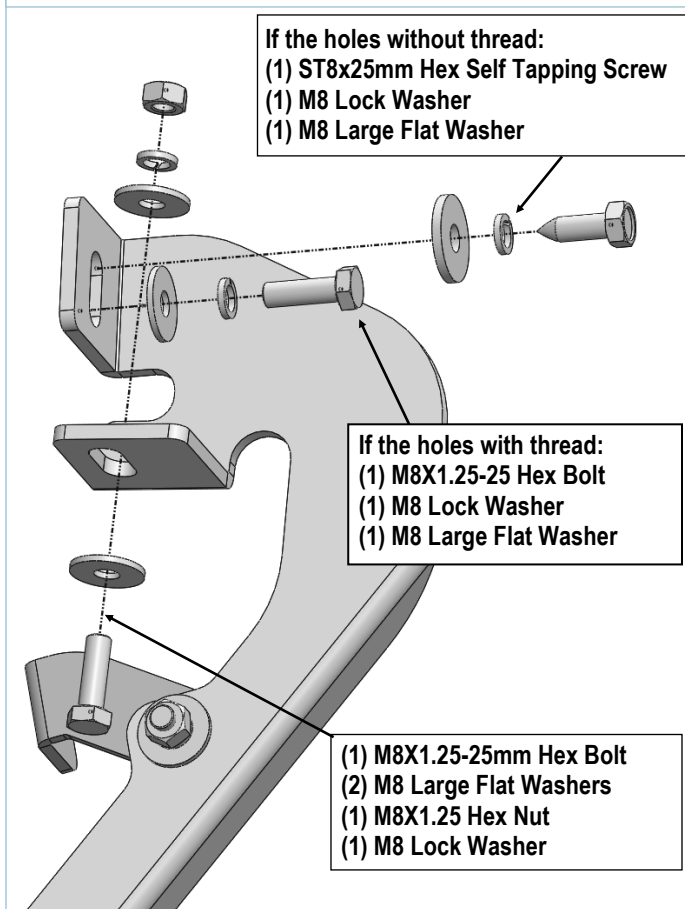

(Fig 3) Passenger Side Front Bracket Installation

STEP 4

Once all (3) Passenger side mounting brackets are installed, select and attach the assembled Passenger Side Step Bar onto the Mounting Brackets with (2) M6X1-20mm Square Head Bolts, (4) M6X1-20mm T-Bolts, (6) M6 Large Flat Washers and (6) M6 Nylon Lock Nuts, (Fig 4). Do not fully tighten hardware at this time.

STEP 5

Properly level and adjust the Step Bar and fully tighten all hardware.

STEP 6

Move to the other side of the vehicle. Repeat **Steps 1—5** for other side Step Bar installation.

Attention

Do periodic inspections to the installation to make sure that all hardware is secure and tight.

In order to protect your bars/boards, please use only mild soap/non-abrasive products for cleaning.

iArmor®

(Fig 4) Passenger Side Step Bar Installation

