

IARMOR EDGE™

PART#: IA-N313

BEFORE INSTALLATION

REMOVE CONTENTS FROM BOX. VERIFY ALL PARTS ARE PRESENT. READ INSTRUCTIONS CAREFULLY BEFORE STARTING INSTALLATION. ASSISTANCE IS RECOMMENDED. THANK YOU FOR CHOOSING OUR PRODUCT!

*DRILLING NOT REQUIRED

*TRIMMING NOT REQUIRED

Torque Value

Fastener Size	Tightening Torque (ft-lbs)	Required
6mm	6-7	√
8mm	16-18	√
10mm	31-32	X
12mm	56-58	X
14mm	92-94	X

PART LIST

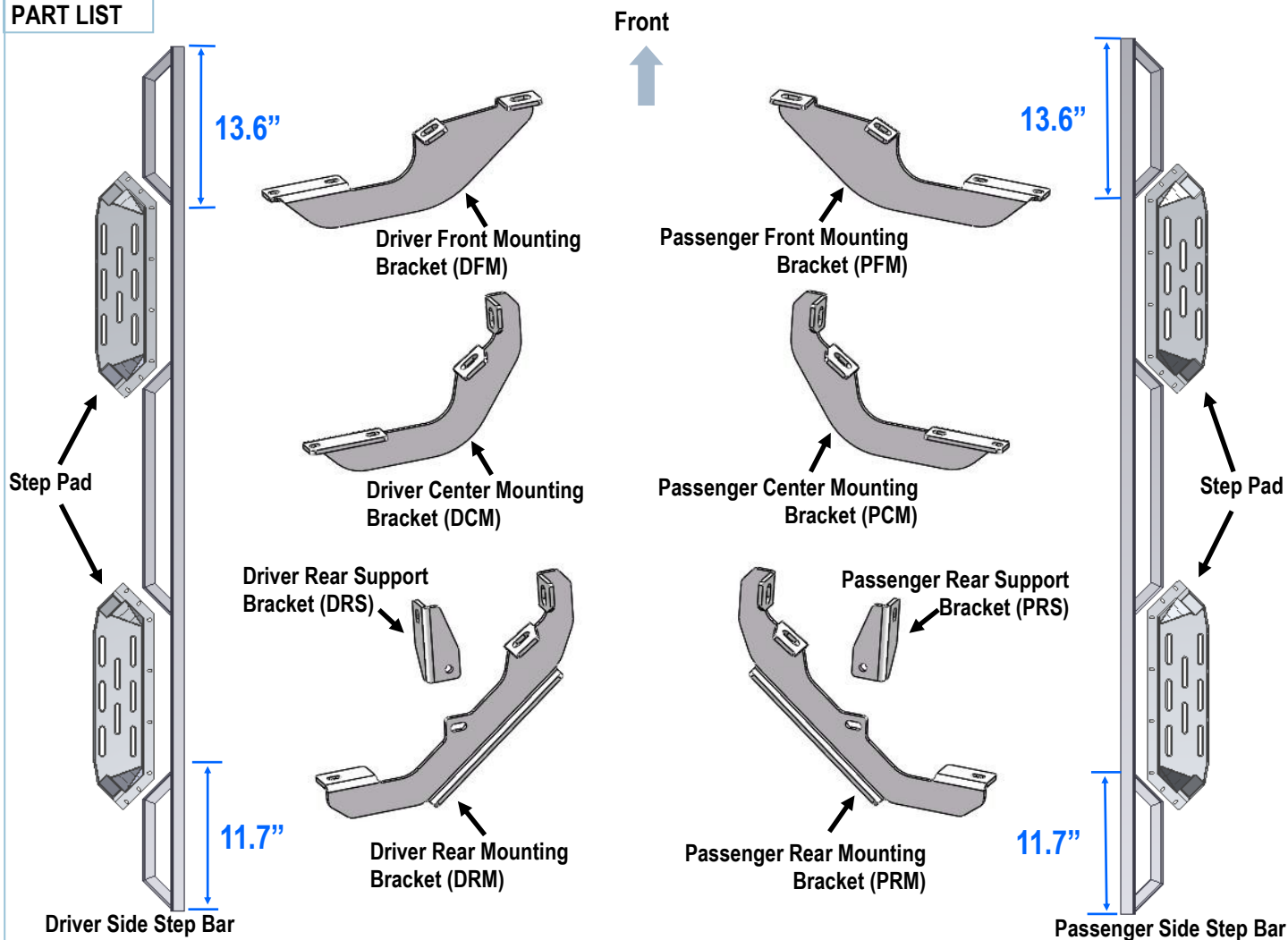

Customer Support: info@iarmorauto.com

iArmor®



M10X1.5-25mm
Hex Bolt



M10 Flat Washer



M10 Lock Washer



M8X1.25-30mm
Hex Bolt



M8 Flat Washer



M8X1.25 Nylon
Lock Nut

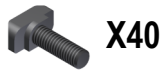

M6X1-20mm T
- Bolt



M6X1-20mm
Square Head Bolt



M6 Large Flat
Washer



M6X1 Nylon
Lock Nut

The instruction here is for your reference only. We strongly recommend the professional installer for best result. We are not responsible for any damage caused by the installation.

STEP 1

Install the Step Pads onto the step bars with (32) M6X1-20mm T-Bolts, (32) M6 Large Flat Washers and (32) M6X1 Nylon Lock Nuts.

IMPORTANT: Don't hit the step pad by any metal hammer within step pad installation, or the step pad will be damaged.

(8) M6X1-20 T-Bolts
(8) M6 Flat Washers
(8) M6 Nylon Lock Nuts

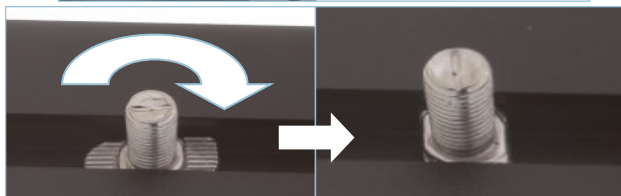

Note: Rotate 90° after inserting the T-Bolts into the Channel!!!

STEP 2

Start the installation under the passenger side of the vehicle. Locate the front factory mounting location along the inner side of the body, (Fig 1).

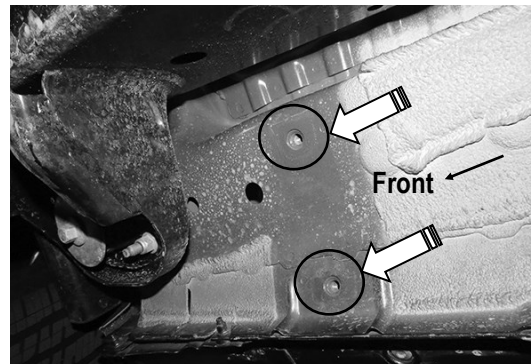

(Fig 1) Passenger Side Front Mounting Location

STEP 3

Remove the plastic plugs covering the mounting holes. Select Passenger Front Mounting Bracket (PFM), (Fig 2). Attach to Passenger side front mounting location with (2) M10x1.5-25mm Hex Bolts, (2) M10 Lock Washers and (2) M10 Flat Washers, (Figs 2 & 3). Do not fully tighten hardware at this time.

iArmor®

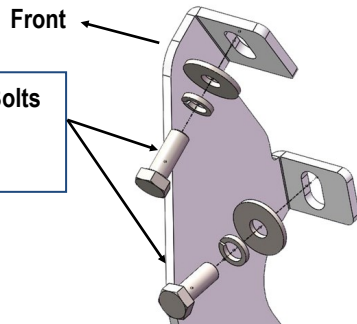

- (2) M10X1.5-25mm Hex Bolts
- (2) M10 Flat Washers
- (2) M10 Lock Washers

(Fig 2) Passenger Front Mounting Bracket Installed

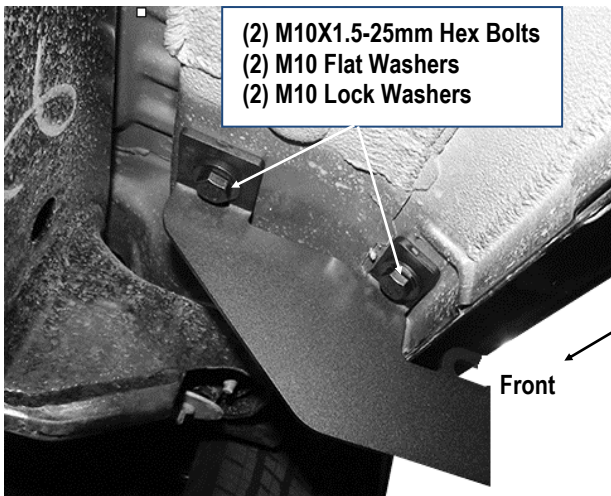

- (2) M10X1.5-25mm Hex Bolts
- (2) M10 Flat Washers
- (2) M10 Lock Washers

(Fig 3) Passenger Front Mounting Bracket Installed

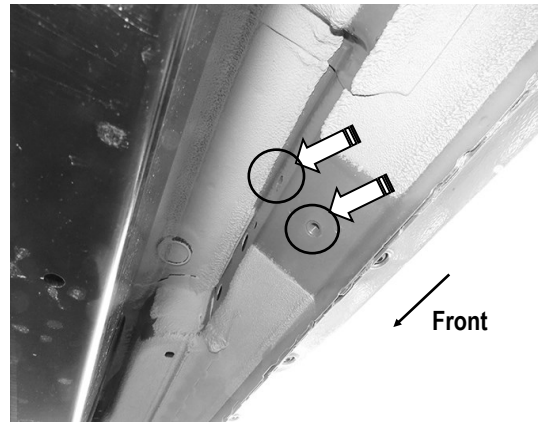

(Fig 4) Passenger Side Center Mounting Location

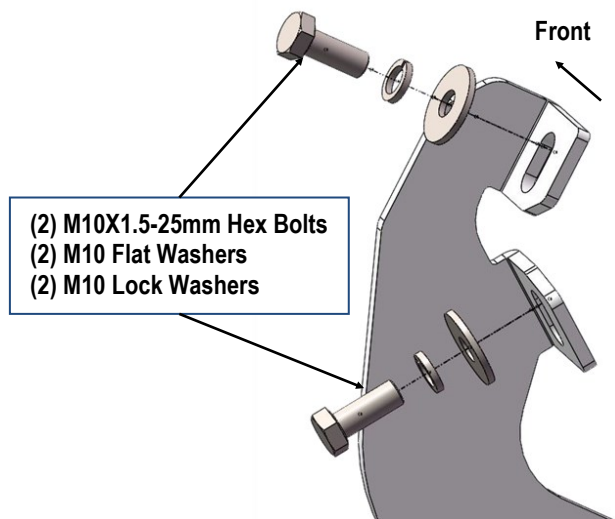

- (2) M10X1.5-25mm Hex Bolts
- (2) M10 Flat Washers
- (2) M10 Lock Washers

(Fig 5) Passenger Center Mounting Bracket Installed

STEP 4

Locate the Center threaded mounting holes. Select (1) Passenger Center Mounting Bracket (**PCM**). Attach with (2) M10x1.5-25mm Hex Bolts, (2) M10 Lock Washers and (2) M10 Flat Washers, (**Figs 4 & 5**). Do not fully tighten hardware at this time.

STEP 5

Repeat **Step 4** to install the Passenger Rear Mounting Bracket (**PRM**), (**Fig 6**). Do not fully tighten hardware at this time.

iArmor®

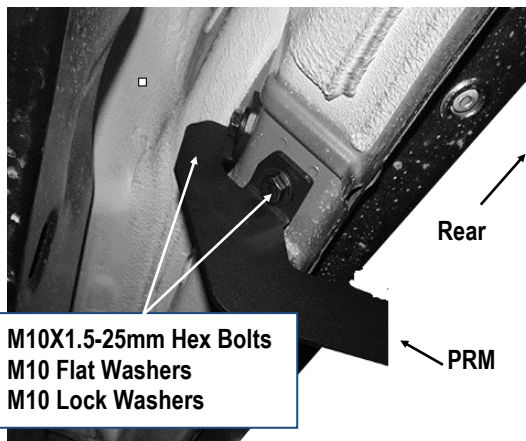

(Fig 6) Passenger Rear Mounting Bracket Installed

STEP 6

Attach the Passenger Rear Support Bracket (**PRS**) to the Passenger Rear Mounting Bracket (**PRM**) with (1) M8X1.25-30mm Hex Bolt, (2) M8 Flat Washers and (1) M8X1.25 Lock Nut, (**Fig 7**). Do not fully tighten hardware at this time.

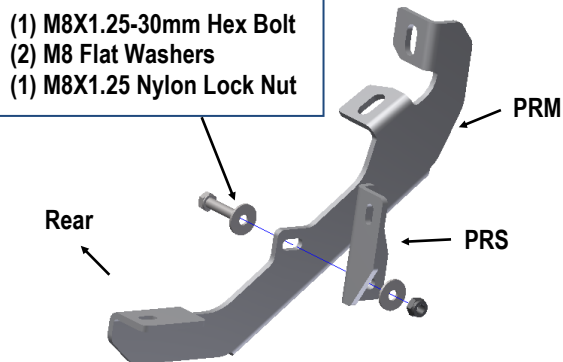

(Fig 7) Passenger Rear Support Bracket Installed

STEP 7

Once all (3) Brackets have been installed, attach the Assembled Passenger Side Step Bar to the Mounting Brackets with (4) M6X1-20mm T-Bolts, (2) M6X1-20mm Square Head Bolts, (6) M6 Large Flat Washers & (6) M6X1 Nylon Lock Nuts, (**Fig 8**). Do not fully tighten hardware at this time.

STEP 8

Properly level and adjust the Step Bar and fully tighten all hardware.

STEP 9

Move to the driver side of the vehicle. Repeat **Steps 2-8** to install driver side step bar.

Attention

Do periodic inspections to the installation to make sure that all hardware is secure and tight.

In order to protect your bars/boards, please use only mild soap/non-abrasive products for cleaning.

iArmor®

(Fig 8) Passenger Side Step Installation

