

iArmor®

IARMOR EDGE™

PART#: IA-N212H

BEFORE INSTALLATION

REMOVE CONTENTS FROM BOX. VERIFY ALL PARTS ARE PRESENT. READ INSTRUCTIONS CAREFULLY BEFORE STARTING INSTALLATION. ASSISTANCE IS RECOMMENDED. THANK YOU FOR CHOOSING OUR PRODUCT!

*ROCKER PANEL MOUNT

*DRILLING NOT REQUIRED

Torque Value

Fastener Size	Tightening Torque (ft-lbs)	Required
6mm	6-7	X
8mm	16-18	√
10mm	31-32	X
12mm	56-58	X
14mm	92-94	X

PART LIST

Driver Side Step Bar

Front
↑

Passenger Side Step Bar

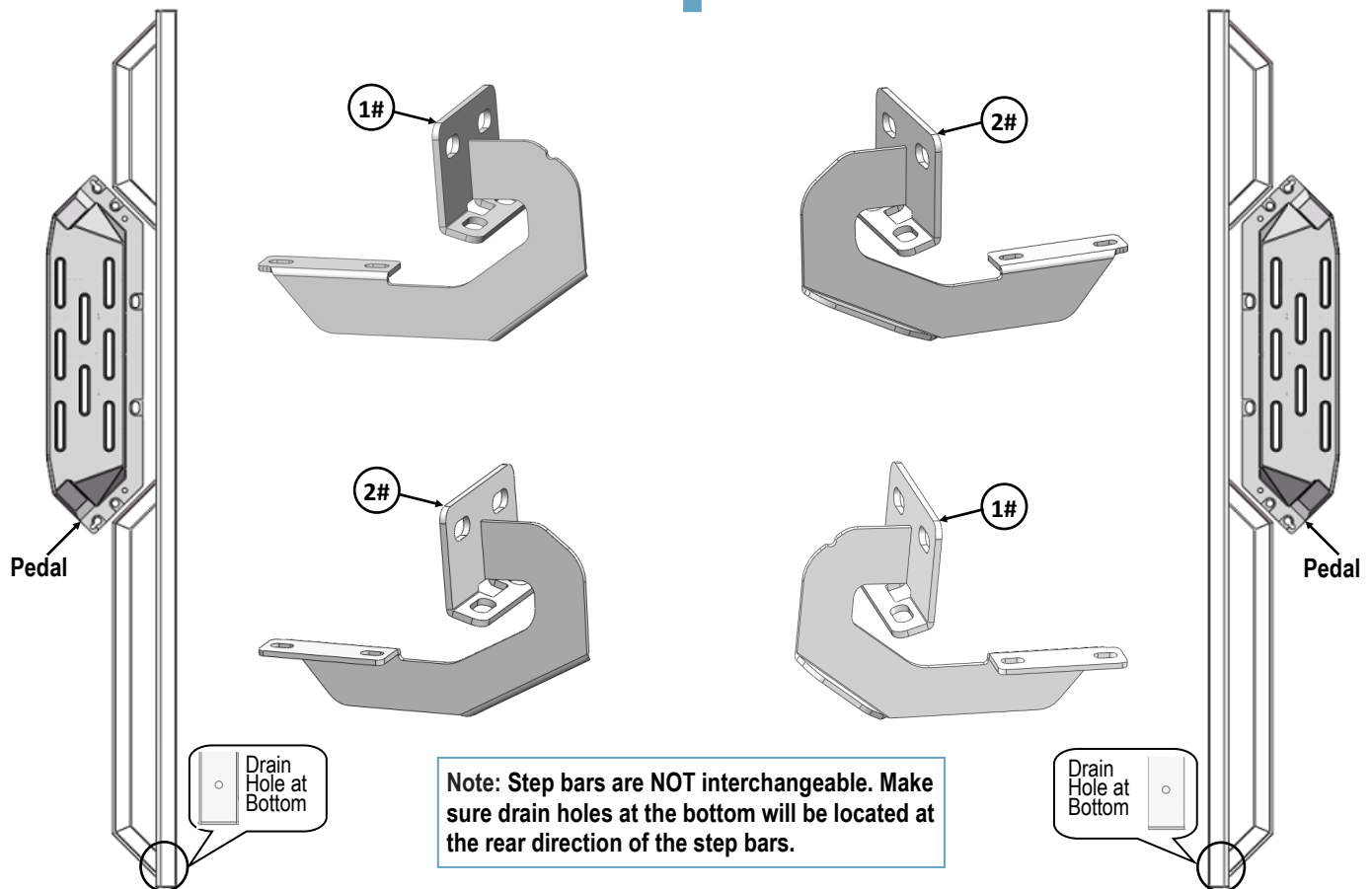

Customer Support: info@iarmorauto.com

iArmor[®]

Hardware Package A (For Brackets & Bars Installation)					
Item	QTY	Description	Item	QTY	Description
1#	2	Driver Front & Passenger Rear Mounting Brackets	7#	16	M8 Lock Washers
2#	2	Passenger Front & Driver Rear Mounting Brackets	8#	8	M8X1.25 Hex Nuts
3#	8	M8X1.25-30mm Hex Bolts	9#	8	M8 Clip Nuts
4#	8	M8X1.25-25mm Hex Bolts	10#	8	M8X1.25-20 T-Bolts
5#	8	M8 Large Flat Washers	11#	8	M8 Plastic Washers
6#	24	M8 Flat Washers	12#	8	M8 Nylon Lock Nuts

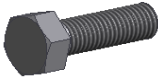

3 #

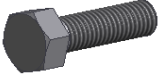

4 #



5 #



6 #



7 #



8 #

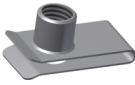

9 #



10 #



11 #



12 #

Hardware Package B (For Step Pedals Installation)					
Item	QTY	Description	Item	QTY	Description
1#	12	M8X1.25-25 Hex Bolts	3#	12	M8 Lock Washers
2#	12	M8 Large Flat Washers			

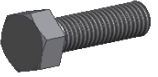

1#



2#



3#

Customer Support: info@iarmorauto.com

iArmor®

The instruction here is for your reference only. We strongly recommend the professional installer for best result. We are not responsible for any damage caused by the installation.

STEP 1

Install (2) Pedals onto the step bars with (12) M8X1.25-25mm Hex Bolts, (12) M8 Large Flat Washers and (12) M8 Lock Washers.

IMPORTANT: Don't punch the pedal with any metal hammer within pedal installation, or the pedal will be damaged.

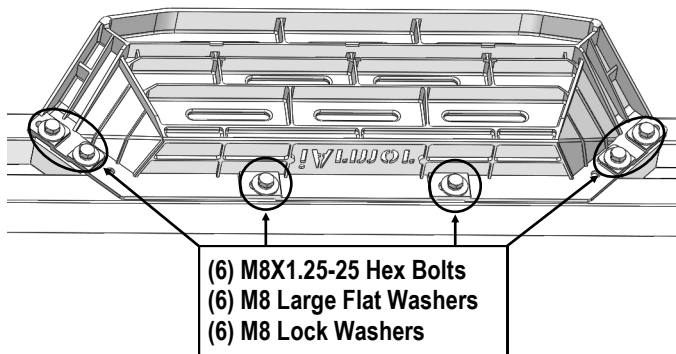

STEP 2

Starting on the driver side of the vehicle, locate the (2) holes on the pinch weld, (Fig 1). And then locate the rectangular opening and (2) small holes on the inner body panel directly above the holes on the pinch weld, (Figs 1&2). Only (1) hole on the pinch weld and (1) small hole on the inner body panel will be used. It will be helpful for Identifying the mounting locations by holding up Brackets in place.

NOTE: The holes on the inner panel may be covered with sealing tape or insulation, remove sealing tape if equipped.

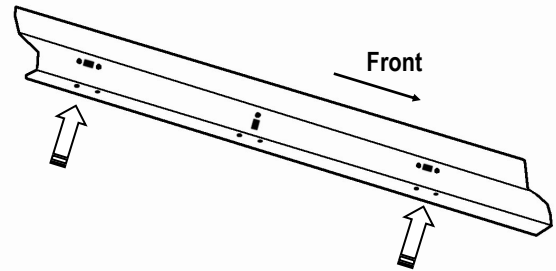

(Fig 1) Driver Side Mounting Locations

STEP 3

Slide (2) M8 Clip Nuts into the rectangular opening with the nut towards the inside. Line up the threaded nut on the clip with the round hole, (Fig 4).

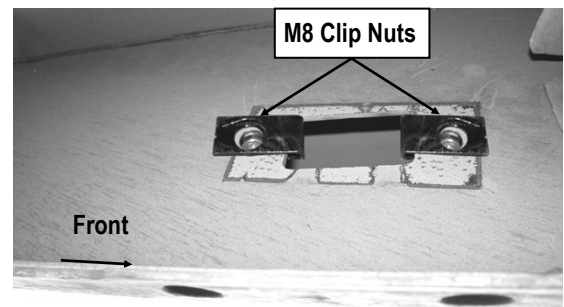

(Fig 2) M8 Clip Nuts Installed
(On Driver Side Front Mounting Location)

STEP 4

Attach the Driver Side Front Mounting Bracket to the installed M8 Clip Nuts with (2) M8X1.25-30mm Hex Bolts, (2) M8 Lock Washers and (2) M8 Large Flat Washers, (Fig 3). Do not fully tighten hardware at this time.

Note: Depending on model/year, the brake cable may be run on the inside or outside of the Bracket.

iArmor®

Align the bottom holes of the Driver Front Mounting Bracket with (2) holes on the pinch weld. Bolt the Bracket to the pinch weld with (2) M8X1.25-25mm Hex Bolts, (4) M8 Flat Washers, (2) M8 Lock Washers and (2) M8 Hex Nuts, (Fig 3).

NOTE: Insert the bolts up from the bottom of the pinch weld and through the Bracket. Do not fully tighten hardware at this time.

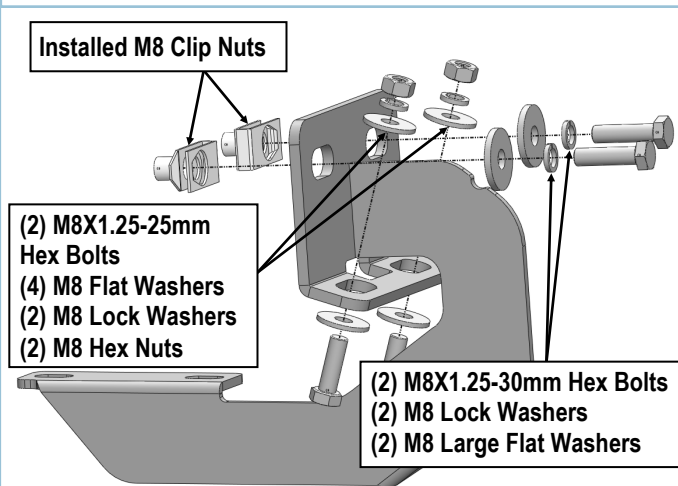

(Fig 3) Driver Front Mounting Bracket Installation

STEP 5

Move to the Driver Side Rear Mounting Location. Locate the mounting holes on the body panel and pinch weld, (Fig 1). Repeat **Steps 2-4** for Driver Rear Mounting Bracket installation. Do not fully tighten hardware at this time.

STEP 6

Once all (2) brackets have been installed, select (4) M8X1.25-20mm T-Bolts, thread (1) M8 Plastic Washer on each T-Bolt, (Fig 4). Install the (4) M8X1.25-20mm T-Bolts with plastic washers in the slots on the assembled Driver side step bar. Rotate the T-Bolts to 90 degree, thread down the M8 Plastic Washers against the step bar (Fig 5).

NOTE: The Plastic Washer is designed to keep the T-Bolt in place to avoid falling into the tube during installation.

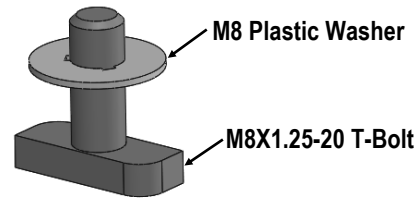

(Fig 4) Thread (1) M8 Plastic Washer on each T-Bolt Before Inserting into the slot !!!

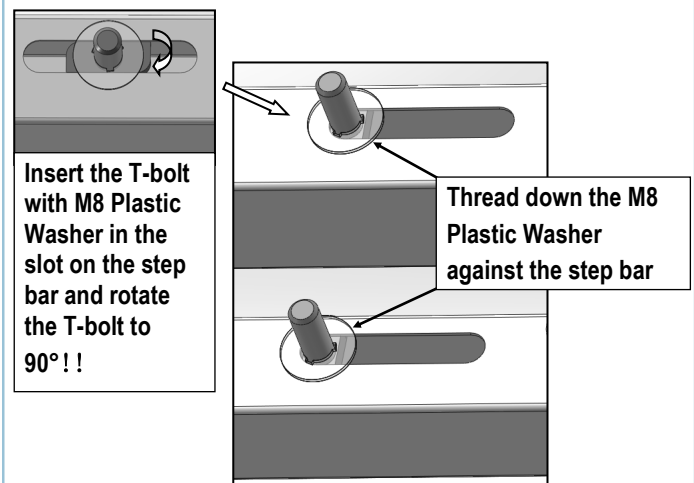

(Fig 5) T-Bolt with plastic washer in the slot

STEP 7

Attach the Assembled Driver Side Step Bar onto the Mounting Brackets with (4) M8 Plastic Washers, (4) M8X1.25-20mm T-Bolts, (4) M8 Large Flat Washers, (4) M8 Nylon Lock Nuts, (Fig 6). Do not fully tighten hardware at this time.

STEP 8

Level and adjust the assembled Step Bar properly and tighten all hardware.

Move to the other side of the vehicle. Repeat **Steps 2-7** for the other side step bar installation.

iArmor®

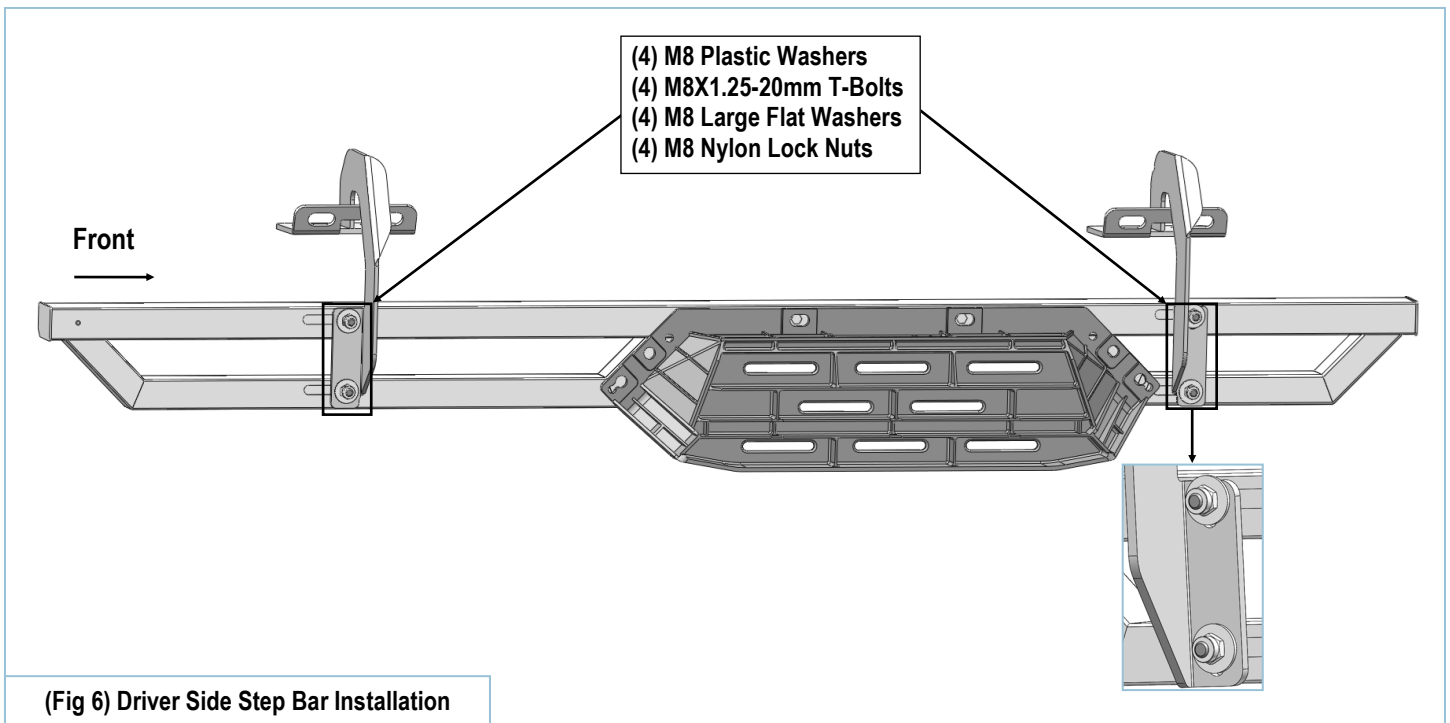

Attention

Do periodic inspections to the installation to make sure that all hardware is secure and tight.
In order to protect your bars/boards, please use mild soap/non-abrasive products for cleaning only.