

iArmor®

IARMOR EDGE™

PART#: IA-W198

BEFORE INSTALLATION

REMOVE CONTENTS FROM BOX. VERIFY ALL PARTS ARE PRESENT. READ INSTRUCTIONS CAREFULLY BEFORE STARTING INSTALLATION. ASSISTANCE IS RECOMMENDED. THANK YOU FOR CHOOSING OUR PRODUCT!

*ROCKER PANEL MOUNT

*DRILLING/TRIMMING NOT REQUIRED

Torque Value

Fastener Size	Tightening Torque (ft-lbs)	Required
6mm	6-7	X
8mm	16-18	√
10mm	31-32	√
12mm	56-58	X
14mm	92-94	X

Driver

Front
↑

Passenger

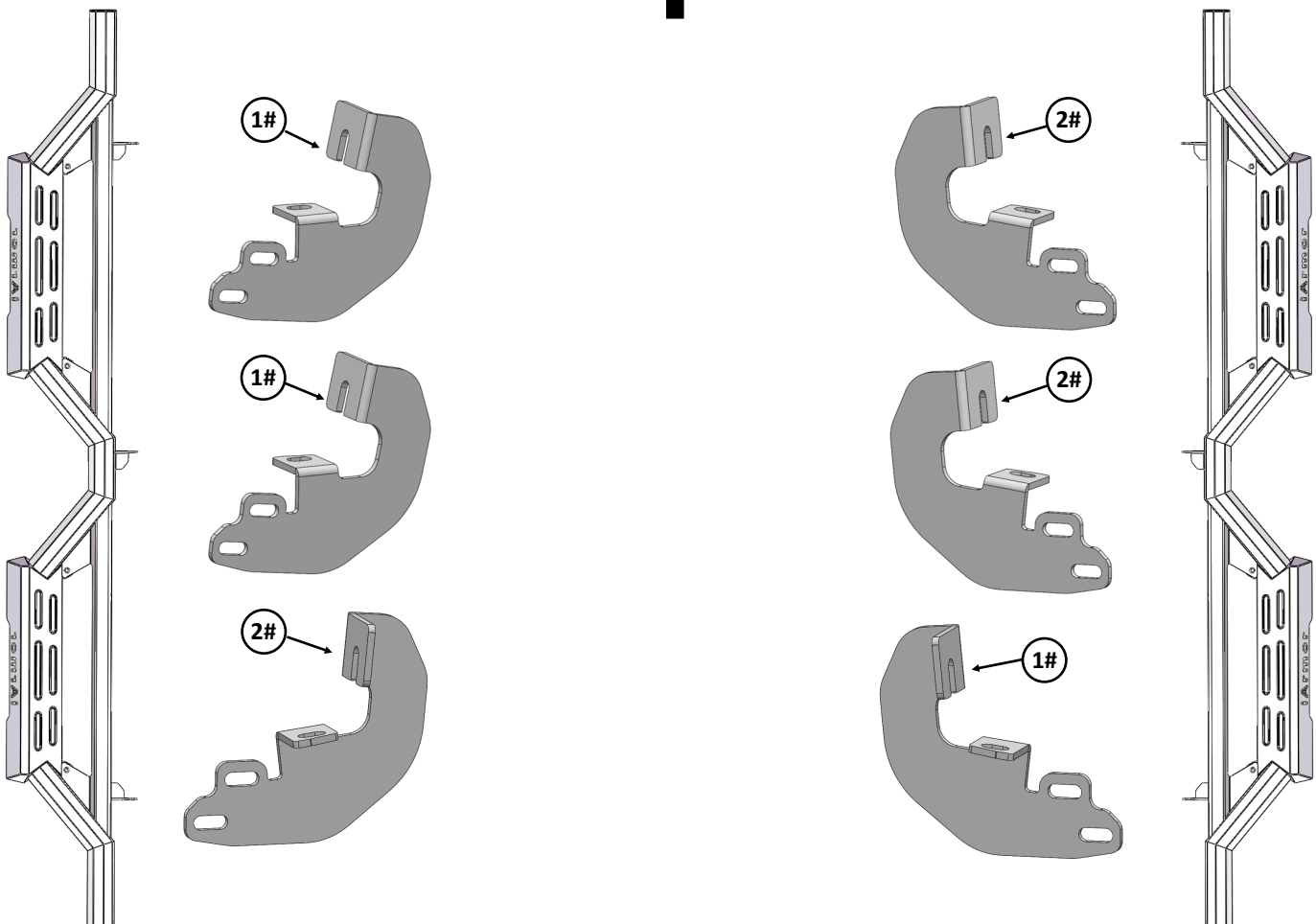

Customer Support: info@iarmorauto.com

iArmor[®]

Hardware Package (For Brackets & Step Bars Installation)

Item	QTY	Description	Item	QTY	Description
1#	3	Driver Front & Center / Passenger Rear Mounting Brackets	6#	12	M8 Clip Nuts
2#	3	Passenger Front & Center / Driver Rear Mounting Brackets	7#	12	M10X1.5-25 Hex Bolts
3#	12	M8X1.25-30 Hex Bolts	8#	24	M10 Flat Washers
4#	12	M8 Large Flat Washers	9#	12	M10 Nylon Lock Nuts
5#	12	M8 Lock Washers			

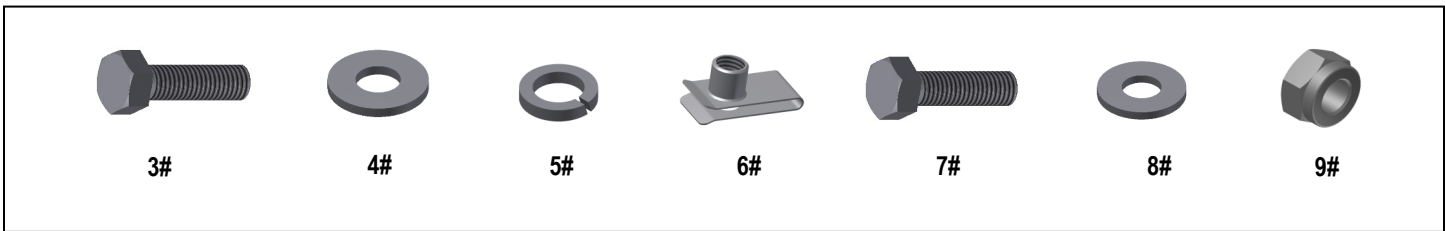

iArmor®

The instruction here is for your reference only. We strongly recommend the professional installer for best result. We are not responsible for any damage caused by the installation.

STEP 1

Start the installation from passenger side of the vehicle. Locate the passenger side mounting locations along the bottom and inner side of the body panel, (Fig 1).

NOTE: It will be helpful for identifying the mounting holes to hold up a mounting bracket in place.

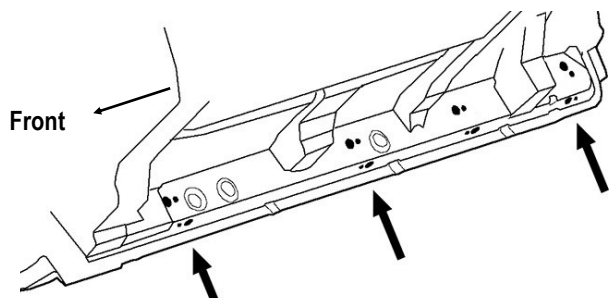

(Fig 1) Passenger side mounting locations

STEP 2

Remove rubber plugs on the Passenger Side Front Mounting Location on body panel if equipped, (Fig 2). Select (2) M8 Clip Nuts. Slide each Clip Nut into each large hole. Line up threaded nut on the Clip Nut with the smaller hole beside the large hole, (Fig 3).

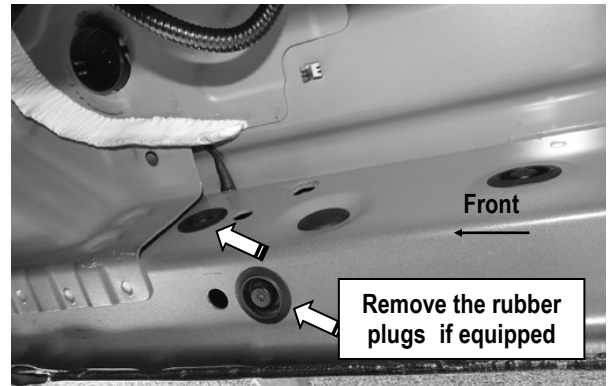

(Fig 2) Passenger Side Front Mounting Location

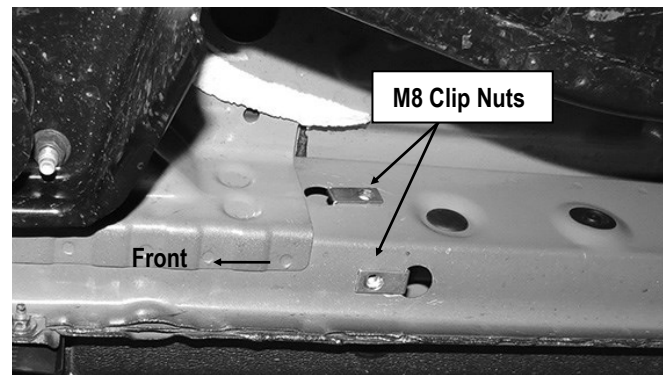

(Fig 3) M8 Clip Nuts Installed
(On Passenger Side Front Mounting Location)

STEP 3

Select (1) Passenger Front Mounting Bracket. Attach the Bracket to the installed (2) M8 Clip Nuts with (2) M8X1.25-30mm Hex Bolts, (2) M8 Lock Washers and (2) M8 Large Flat Washers, (Figs 4 & 5). Do not fully tighten hardware at this time.

Note: Passenger Front / Center Mounting Brackets and Driver Rear Mounting Bracket are the same.

iArmor®

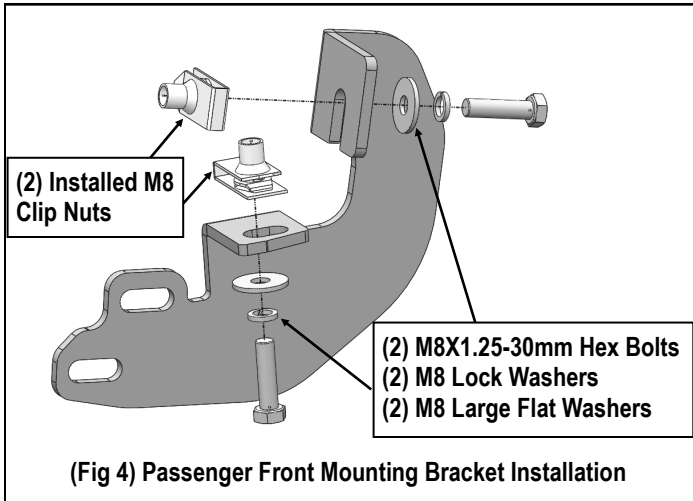

STEP 4

Move to Passenger Side Center & Rear Mounting location, (Figs 5 & 6). Repeat **Steps 1—3** to install (1) Passenger Center Mounting Bracket and (1) Passenger Rear Mounting Bracket, (Fig 7). Do not fully tighten hardware at this time.

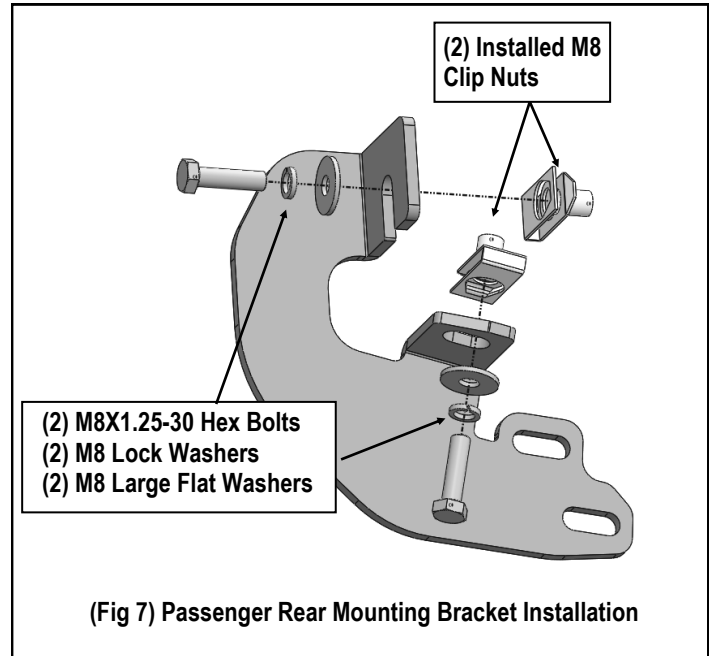
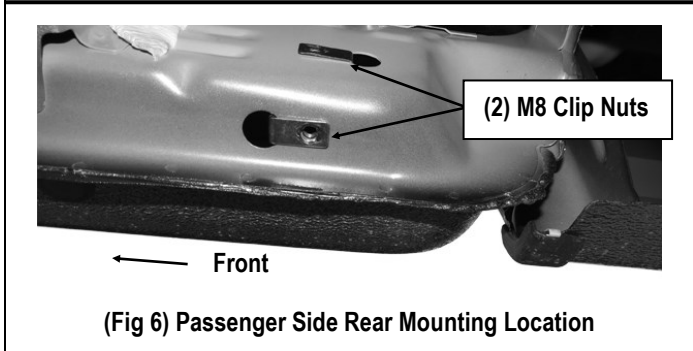
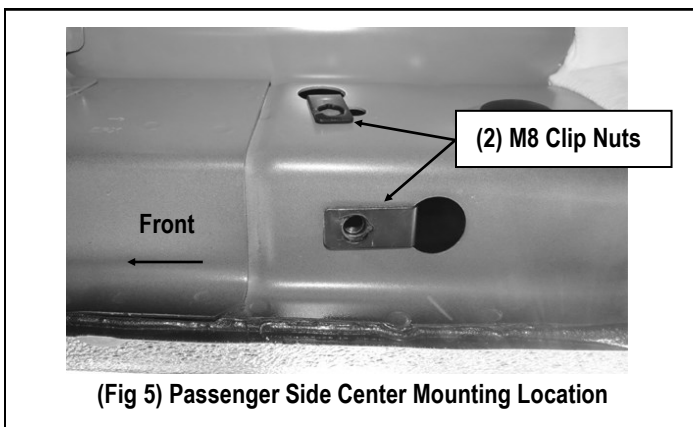

STEP 5

Once all (3) Mounting Brackets have been installed, attach the Passenger Side Step Bar to the Mounting Brackets with (6) M10X1.5-25 Hex Bolts, (12) M10 Flat Washers and (6) M10X1.5 Nylon Lock Nuts, (Fig 8). Do not fully tighten hardware at this time.

STEP 6

Properly level and adjust the Step Bar and fully tighten all hardware.

STEP 7

Move to the other side of the vehicle. Repeat **Steps 1—6** for other side Step Bar installation.

Attention

Do periodic inspections to the installation to make sure that all hardware is secure and tight.

In order to protect your bars/boards, please use mild soap/non-abrasive products for cleaning only.

iArmor[®]

